

# MANUALS

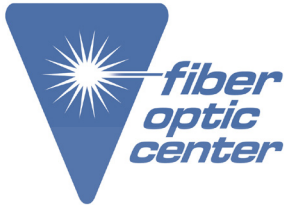

**Manufacturer:**  
Drucker Diagnostics

**Product Name:**  
Drucker Diagnostics HORIZON 6 Flex FA Fixed Angle Routine Centrifuge,  
Digital Display, 10 Preset Cycles, RPM 1000-3800, CE Rated

**Manufacturer Part Number:**  
00-376-009-001

▶ [Click here for more details on the Drucker Diagnostics HORIZON 6 Flex FA Fixed Angle Routine Centrifuge, Digital Display, 10 Preset Cycles, RPM 1000-3800, CE Rated](#)



[Operators Manual](#)

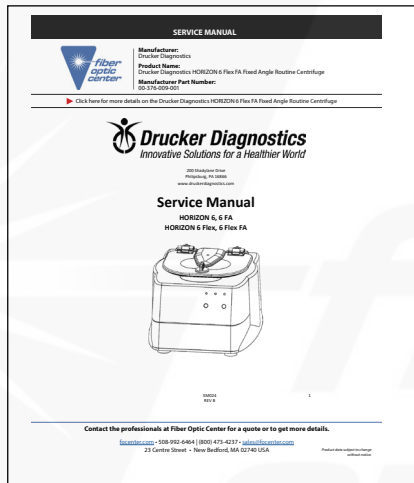

[Service Manual](#)

**Contact the professionals at Fiber Optic Center for a quote or to get more details.**

[focenter.com](http://focenter.com) • 508-992-6464 | (800) 473-4237 • [sales@focenter.com](mailto:sales@focenter.com)

23 Centre Street • New Bedford, MA 02740 USA

Product data subject to change without notice. FOC last update 4/22/2026.

# OPERATOR'S MANUAL

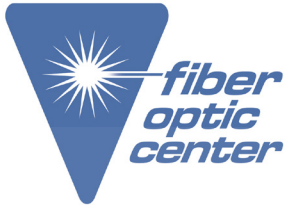

**Manufacturer:**  
Drucker Diagnostics

**Product Name:**  
Drucker Diagnostics HORIZON 6 Flex FA Fixed Angle Routine Centrifuge, Digital Display, 10 Preset Cycles, RPM 1000-3800, CE Rated

**Manufacturer Part Number:**  
00-376-009-001

▶ [Click here for more details on the Drucker Diagnostics HORIZON 6 Flex FA Fixed Angle Routine Centrifuge, Digital Display, 10 Preset Cycles, RPM 1000-3800, CE Rated](#)

# HORIZON

6 Flex, 6 Flex FA  
*Operator's Manual*



>> [Return to Page 1](#)

**Contact the professionals at Fiber Optic Center for a quote or to get more details.**

[focenter.com](http://focenter.com) • 508-992-6464 | (800) 473-4237 • [sales@focenter.com](mailto:sales@focenter.com)

23 Centre Street • New Bedford, MA 02740 USA

Product data subject to change without notice. FOC last update 4/22/2026.

## TABLE OF CONTENTS

Symbols.....	1
Model Description .....	2
Features .....	2
Intended Use .....	2
Caution and Warning Statements.....	3
Initial Setup.....	5
Operation.....	5
Quick Start .....	6
Single Cycle Lock .....	7
Preset Lock.....	7
Display Cycle Count.....	7
Setting or Modifying a Cycle .....	8
Settings .....	8
Balancing Loads.....	9
Care and Preventative Maintenance .....	9
Cleaning and Disinfection .....	10
Troubleshooting.....	11
General Specifications .....	13
Calculating the G-Force.....	15
Previous Manual Revisions .....	15
Replacement Parts.....	16

>> Return to Page 1









**Contact the professionals at Fiber Optic Center for a quote or to get more details.**

[focenter.com](http://focenter.com) • 508-992-6464 | (800) 473-4237 • [sales@focenter.com](mailto:sales@focenter.com)

23 Centre Street • New Bedford, MA 02740 USA

Product data subject to change without notice. FOC last update 4/22/2026.

## Symbols

Symbol	Definition	Use
	Caution	Caution to safety hazard. Potential risk of personal injury or damage to the instrument if improperly handled. Consult the manual before proceeding.
	Manufacturer	Manufacturer of record.
	Electrical and electronic products recycling symbol	Recycle only as electronic waste. Do not dispose in normal waste.
	RoHS Compliant	Compliance with RoHS environmental standards.
	CE Mark	Denotes conformity to specific European directives and regulations.
	MET Listing	Denotes conformity to specific safety standards and regulations.
	UK Mark	Denotes conformity to specific UK directives and regulations.
	FDA Listed	Denotes that the product has been properly listed with the FDA.
	ISO Certification	Denotes conformity to quality standards and quality management systems.

**Contact the professionals at Fiber Optic Center for a quote or to get more details.**

[focenter.com](http://focenter.com) • 508-992-6464 | (800) 473-4237 • [sales@focenter.com](mailto:sales@focenter.com)

23 Centre Street • New Bedford, MA 02740 USA

## MODEL DESCRIPTION

HORIZON is a versatile line of centrifuges designed with 3 settings to process Chemistry, Coag or Platelet Poor Plasma, and Urine specimens in the same unit. The maximum g-force of 2,000 xg makes HORIZON suitable for wide variety of applications. Cycle settings can be changed to accommodate custom settings.

This general-purpose laboratory centrifuge may also be used to spin approved containers with biologics, chemicals (non-flammable, non-explosive, non-volatile, and non-highly reactive), and environmental samples.

## FEATURES

- Default cycles are conveniently pre-set and labeled for your lab's most common applications. Use the default cycles or customize them as needed.
- If desired, the control panel can be temporarily locked on one cycle for error-free reproducibility and ideal for standardization to a single spin.
- Up to 10 cycles can be programmed for time, speed, and braking and labeled with a custom name. Cycles can be programmed by g-force (RCF) rather than speed to facilitate matching validated cycles and manufacturers IFUs.
- Lid lighting indicates the centrifuge's status (ready, running, done), informing the operator when tubes are ready for the analyzer and preventing tubes from being left in the centrifuge longer than necessary (patent pending).
- A traditional audible alert indicates the completion of the cycle. The audible alert can be muted.
- Cool-Flow design prevents overheating of samples by using ambient air to keep specimens at room temperature.
- The tube holders are fiber reinforced for high strength, durability, and years of trouble-free use.
- A clear lid permits safe observation of samples and optical calibration of speed.
- The lid safety system prevents the centrifuge from operating unless the lid is closed and latched.
- The lid safety system only allows entry into the centrifuge after the rotor has completely stopped.
- The high-power brushless motor provides years of operation with no routine maintenance.

## INTENDED USE

General purpose laboratory centrifuge, intended for the density-based separation of fluids through centripetal acceleration.

**Contact the professionals at Fiber Optic Center for a quote or to get more details.**

[focenter.com](http://focenter.com) • 508-992-6464 | (800) 473-4237 • [sales@focenter.com](mailto:sales@focenter.com)

23 Centre Street • New Bedford, MA 02740 USA

## CAUTION AND WARNING STATEMENTS



This device is intended to be operated by properly trained personnel who have carefully read the operating manual and are familiar with the function of the device. [Refer to the clinical laboratory method specified by the specimen receptacle manufacturer or established by the medical technology for the products applications.]



**WARNING:** For the safety of both the operator and service personnel, care should be taken when using this centrifuge if handling substances that are known to be toxic, radioactive or contaminated with pathogenic microorganisms. Use appropriate personal protection equipment (PPE). When Risk Group II materials are used, (as identified in the World Health Organization "Laboratory Bio-Safety Manual"), a Bio- Seal should be employed. In the event that materials of a higher risk group are being used, more than one level of protection must be provided. The use of flammable or explosive materials as well as those materials which have a vigorous chemical reaction is prohibited.



Unplug the centrifuge before cleaning or performing maintenance.



**WARNING:** Inspect centrifuge for cracks or physical damage to cabinet, lid, rotor, or tube holders. Damage may result in unsafe operation. Discontinue use until repairs have been performed.



The use of flammable or explosive materials as well as those materials which have a vigorous chemical reaction is prohibited.



For your safety and durability of the machine, never transport or store centrifuge with tube holders inside the machine.



**WARNING:** "Universal precautions"<sup>1</sup> should be followed in handling all items contaminated with blood or other bodily fluids.



This equipment generates, uses, and can radiate radio frequency energy, and if not installed and used in accordance with this operator manual, may cause interference to radio communications.



Operation of this equipment in a residential area may cause interference, in which case the user will be required to correct the interference at his own expense.



Operation of this equipment in a manner not specified by the manufacturer may impair the protection provided by the equipment.

**Contact the professionals at Fiber Optic Center for a quote or to get more details.**

[focenter.com](http://focenter.com) • 508-992-6464 | (800) 473-4237 • [sales@focenter.com](mailto:sales@focenter.com)

23 Centre Street • New Bedford, MA 02740 USA



Electrical Safety protection is provided by properly connecting the centrifuge to earth ground. Use only the manufacturer provided line cord and ensure that it is connected to a properly grounded power receptacle. Failure to do so will result in an electrical hazard.



WARNING: Do not make modifications to or remove any hardware from rotor without prior authorization from Drucker Diagnostics.



WARNING: Only use Drucker Diagnostics components in this centrifuge.



Important Operating Instructions: This model centrifuge requires at least 2 tube holders inserted when attempting to run. Running the centrifuge with an empty rotor may cause a motor error and will require a power cycle to fully reset (see Troubleshooting section on page 9).

1 Recommendations for Prevention of HIV Transmission in Health Care Settings. MMWR 1987; 36 (Supplement #2S)

*fiber  
optic  
center*

**Contact the professionals at Fiber Optic Center for a quote or to get more details.**

[focenter.com](http://focenter.com) • 508-992-6464 | (800) 473-4237 • [sales@focenter.com](mailto:sales@focenter.com)

23 Centre Street • New Bedford, MA 02740 USA

## INITIAL SETUP

- Unpack and verify that all the following are included:
  - Centrifuge
  - Power cord
  - Tube holders
  - Quick Start Guide
- Setup the centrifuge on flat and level surface. A bench top clearance height of 21" (54 cm) is required to open the lid.
- The centrifuge should have 6" (15 cm) of clear space around the centrifuge. Proper ventilation is necessary to prevent the overheating of samples as well as premature failure of the centrifuge. Choose an area which allows unencumbered air flow, and where the temperature remains between 16°C and 32°C.
- No hazardous material shall be permitted in the clearance envelope during operation.
- The operator time within the envelope shall be limited to the time necessary for loading, unloading, and centrifuge operation only.
- Plug the line cord into the centrifuge.
- Plug the line cord into an approved electrical outlet.
- Turn on the power switch in the back of the centrifuge.



BE SURE THE ELECTRICAL OUTLET IS ALWAYS ACCESSIBLE AS THE LINE CORD IS THE MEANS OF EMERGENCY DISCONNECTION!

## OPERATION

- Place the tubes into the tube holders. Be sure to follow the rules for balanced loads as listed on page 9.
- Close the lid and turn the lid knob clockwise to its complete stop position.
- The digital screen shows the currently selected cycle. To select another cycle, press the UP or DOWN button in succession until the desired cycle is selected.
- Pushing the START button on the control panel will start the spin cycle.
- When the cycle is completed, the rotor will slow to a complete stop and the lid light will flash.
- The unlocking mechanism will engage for 60 seconds allowing entry into the rotor chamber. To unlock after more than 60 seconds have elapsed, press the UNLOCK button.
- Turn the lid knob counterclockwise and open the lid. The lid light will turn off.

**Contact the professionals at Fiber Optic Center for a quote or to get more details.**

[focenter.com](http://focenter.com) • 508-992-6464 | (800) 473-4237 • [sales@focenter.com](mailto:sales@focenter.com)

23 Centre Street • New Bedford, MA 02740 USA

## QUICK START

The screen display alternates between the name of the currently selected cycle and its parameters. For convenience, default cycles are pre-set for common applications and can be reprogrammed to your validated cycles:

- |                |   |
|----------------|---|
| (1) Chemistry  | This setting is factory pre-set for Chemistry tubes                           |
| (2) Coag (PPP) | This setting is factory pre-set for Coagulation or Platelet Poor Plasma (PPP) |
| (3) Urine      | This setting is factory pre-set for urine tubes                               |



	<b>Start</b>	Begins running the cycle displayed on the screen. The lid must be closed.
	<b>Unlock</b>	Allows access into the rotor chamber by engaging the unlocking mechanism. Entry is only possible when the rotor is stopped.
	<b>Stop</b>	Pressing the UNLOCK button during operation will terminate the run. Once the rotor has come to a stop, pressing the UNLOCK button again will open the centrifuge lid.
	<b>Cycle Selection</b>	Press the up and down buttons next to the screen to select the desired saved cycle.



To ensure repeatability, the centrifuge can be locked either on one cycle (Single Cycle Lock) or restricted to the current saved cycles (Preset Lock). The Single Cycle Lock also prevents making changes to the parameters of the selected cycle. The Preset Lock allows selection of any saved cycle but prevents changing the parameters of saved cycles.

**Contact the professionals at Fiber Optic Center for a quote or to get more details.**



[focenter.com](http://focenter.com) • 508-992-6464 | (800) 473-4237 • [sales@focenter.com](mailto:sales@focenter.com)

23 Centre Street • New Bedford, MA 02740 USA

### SINGLE CYCLE LOCK



	<b>Lock on Single Cycle</b>	Select desired cycle. Press and hold the UNLOCK button for 5 seconds. Two beeps will confirm that cycle selection is locked.
	<b>Cancel Single Cycle Lock</b>	To re-enable cycle selection, press and hold the UNLOCK button for 5 seconds. Three beeps will confirm that cycle selection is now unlocked.

### PRESET LOCK

	<b>Enter Settings Mode</b>	Press the GEAR button.
	<b>Lock Saved Cycles</b>	Press and hold the UNLOCK button for 5 seconds. Two beeps will confirm that the Preset Lock is active.
	<b>Cancel Preset Lock</b>	With lid open and while not in Settings mode, press and hold the UNLOCK button for 5 seconds until two beeps are heard. Saved cycles can again be edited or programmed.

### DISPLAY CYCLE COUNT

These actions will display the cycle count.

	<b>Enter Settings Mode</b>	Press the GEAR button.
	<b>Navigate to Cycle Counter</b>	Press the left arrow once to access the cycle counter
	<b>Exit Settings Mode</b>	Press the GEAR button.







**Contact the professionals at Fiber Optic Center for a quote or to get more details.**

[focenter.com](http://focenter.com) • 508-992-6464 | (800) 473-4237 • [sales@focenter.com](mailto:sales@focenter.com)

23 Centre Street • New Bedford, MA 02740 USA

## SETTING OR MODIFYING A CYCLE

Up to 10 cycles can be named, programmed for time, speed, and braking, and saved in memory.

	<b>Cycle Selection</b>	Press the up and down buttons next to the screen to select the desired cycle.
	<b>Enter Programming Mode</b>	Press the GEAR button.
	<b>Navigate between Parameters</b>	Use the left and right arrow button until the parameter to be edited is blinking and underlined.
	<b>Change Parameter Values</b>	To change the parameter shown on the display, use the up and down buttons next to the screen.
	<b>Displaying the Correct g-force</b>	<b>HORIZON Flex FA only:</b> To display the real g-force (RCF) for the cycle, the right tube holder must be selected. Universal blue tube holders accommodate 75 and 100 mm tubes. 125 mm tubes require the orange tube holder. If the tube holder selection in the program does not match the tube holder used, the RCF number displayed will not reflect the actual value.
	<b>Naming the Cycle</b>	Navigate to the cycle name with the left and right arrow. Change the blinking character of the name with the up and down buttons, then move to the next character with the right arrow. Repeat.
	<b>Save and Exit Programming Mode</b>	Press the GEAR button. The cycle displayed on the screen will be automatically saved.

## SETTINGS

		(1) Chemistry	(2) Coag (PPP)	(3) Urine
<b>HORIZON 6 Flex</b>	<b>RPM</b>	3,600	3,300	1,900
	<b>Time (mins)</b>	10	15	5
	<b>G-Force</b>	1,850 xg	1,550 xg	500 xg
<b>HORIZON 6 Flex FA</b>	<b>RPM</b>	3,900	3,800	2,200
	<b>Time (mins)</b>	10	15	5
	<b>G-Force (75 &amp; 100 mm tubes)</b>	1,650 xg	1,550 xg	500 xg
	<b>G-Force (125 mm tubes)</b>	1,850 xg	N/A	600 xg

Contact the professionals at Fiber Optic Center for a quote or to get more details.

## BALANCING LOADS



**Your centrifuge must contain a balanced load to work properly.** Spinning balanced loads will extend the life of the centrifuge and produce better results. Use the following rules when loading the rotor. If an odd number of samples is to be spun, fill a tube with water to match the weight of the unpaired sample and place it across from this sample.

*Opposing tube holders must be equally loaded or empty or loaded with equally weighted samples.  
When loading only 3 tubes, they must be of equal weight.*

### 6 Tube Centrifuges

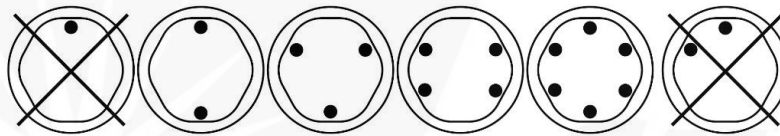

## CARE AND PREVENTATIVE MAINTENANCE

With proper care and maintenance, your centrifuge will provide years of laboratory service. For proper care, the following steps should be taken:

- **Always Spin Balanced Loads:** Make certain that you are always spinning a balanced load, as shown in the previous section. These centrifuges have a unique counter balanced motor mounting design which produces excellent vibration dampening. However, out-of-balance loads may break glass test tubes and may produce unsatisfactory separation results. Proper load balancing will improve sample separation and extend the life of the centrifuge.
- **Motor and Electrical Maintenance:** The highest quality electrical components have been selected for the centrifuges and should not need maintenance or servicing for the life of the centrifuge.
- **Tube Holder Replacement:** It is recommended that the tube holders be replaced after 24 months of use. Inspect tube holders regularly for cracks. If cracks are discovered, replace immediately.
- **Remove Accessories Before Moving:** All tube holders, samples, and caps must be removed from the rotor chamber before transporting or storing the centrifuge to prevent damage and injury.

**Contact the professionals at Fiber Optic Center for a quote or to get more details.**

[focenter.com](http://focenter.com) • 508-992-6464 | (800) 473-4237 • [sales@focenter.com](mailto:sales@focenter.com)

23 Centre Street • New Bedford, MA 02740 USA

## CLEANING AND DISINFECTION

To prolong the life of the centrifuge, cleaning and disinfection is recommended every six months or whenever there is spillage or tube breakage. Contaminants must be removed immediately, or corrosion and premature degradation of components can occur. Before using any cleaning or decontamination methods other than those recommended by the manufacturer, users should verify with the manufacturer that the proposed method will not damage the equipment.



Cleaning and Decontamination may be necessary as a safeguard before laboratory centrifuges, rotors, and any accessories are maintained, repaired, or transferred.

- Unplug the centrifuge before cleaning.
- Use appropriate personal protective equipment (PPE).
- Apply cleaning solutions with a dampened towel or cloth **ONLY**. Do not spray or pour cleaning solution directly onto or into the centrifuge. Do not saturate the centrifuge or submerge the centrifuge in water or other cleaning solutions as this will cause damage, create a safety risk, and void the warranty.
- **ONLY** isopropyl alcohol or a 10% (5500 PPM) bleach solution should be used to disinfect the centrifuge and its accessories.
- All surfaces must be dried immediately after cleaning and disinfecting.



**TBQ GERMICIDAL PRODUCTS ARE NOT RECOMMENDED AS THEY MAY CAUSE DAMAGE TO THE CENTRIFUGE. WIPE OFF THOROUGHLY AFTER USE TO PREVENT VOIDING THE WARRANTY.**

- Fully/partially halogenated hydrocarbons, ketones, esters, ethers, benzyls, ethyl benzenes, and all other chemicals not prescribed by the manufacturer shall not be used as they may cause damage to the rotor chamber, rotor, tube holders, accessories and centrifuge exterior and void the warranty.

**Contact the professionals at Fiber Optic Center for a quote or to get more details.**

[focenter.com](http://focenter.com) • 508-992-6464 | (800) 473-4237 • [sales@focenter.com](mailto:sales@focenter.com)

23 Centre Street • New Bedford, MA 02740 USA

## TROUBLESHOOTING

**NOTE:** The latch must be turned completely clockwise to its stop position for the centrifuge to operate.

<p><b>The centrifuge does not run</b></p>	<ul style="list-style-type: none"> <li>○ Verify that the centrifuge is powered. The screen should be lit.</li> <li>○ If “Lid not closed” or “Lid Open” message is displayed, make sure the lid latch is turned completely clockwise to its stop position.</li> <li>○ If the centrifuge still does not run, contact Customer Service.</li> </ul>
<p><b>The rotor does not spin freely</b></p>	<ul style="list-style-type: none"> <li>○ Make sure nothing has fallen into the rotor chamber, following the procedure above.</li> <li>○ If nothing obstructs the rotor, the rotor may be damaged. Contact Customer Service for further assistance.</li> </ul>
<p><b>The centrifuge makes a rattling noise when running</b></p>	<ul style="list-style-type: none"> <li>○ Stop the centrifuge. Open the lid.</li> <li>○ Wearing PPE, remove tubes and tube holders/buckets and look for fallen objects or debris. Carefully reach inside the rotor chamber with a tool to remove them.</li> <li>○ Inspect the rotor, tube holders or buckets for damage.</li> <li>○ If the tube holders or buckets have any damage, even slight, safely dispose of them and replace them.</li> <li>○ If the rotor appears damaged, contact Customer Service for further assistance.</li> </ul>
<p><b>Excessive noise or vibration when the centrifuge is running</b></p>	<ul style="list-style-type: none"> <li>○ Verify that all four centrifuge feet are properly seated on a flat surface.</li> <li>○ Ensure that the load is balanced according to instructions in the “Balancing Loads” section of this manual.</li> <li>○ Make sure that nothing has fallen into the rotor chamber.</li> </ul>
<p><b>The centrifuge stops and beeps continuously</b></p>	<p>The load is not balanced. Press the UNLOCK button, open the lid, and balance the load as recommended elsewhere in this manual.</p> <p>Confirm that all tube holders are properly loaded into the Centrifuge rotor.</p>
<p><b>The centrifuge is showing Motor Error on the screen</b></p>	<p>Turn Off unit until all LEDs and Displays are fully out (may take up to 10 seconds). Turn the unit back on. If the centrifuge is not fully power cycled after a motor error, the system will continue to fail for motor errors on subsequent runs. Make sure centrifuge rotor contains at least 2 samples tubes or empty tubes holders before running. If the error persists after power cycling and the rotor is not empty, contact Customer Service for further assistance.</p>
<p><b>The centrifuge is stuck on one of the settings</b></p>	<p>Cycle selection is locked. Press and hold the UNLOCK button for 5 seconds.</p>

**Contact the professionals at Fiber Optic Center for a quote or to get more details.**

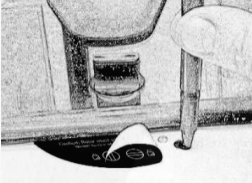
<p><b>The cycle time and speed are not set to the desired value</b></p>	<p>Check the setting by following the instructions in the section on Changing Cycle Settings. If the preset is not the desired length, follow the procedure on the same page to change the preset time.</p>
<p><b>Cycle parameters cannot be changed</b></p>	<ul style="list-style-type: none"> <li>○ If cycle selection is locked on one cycle, press the UNLOCK button for 5 seconds. Then, press the GEAR button and follow the instructions elsewhere in this manual.</li> <li>○ If different saved cycles can be selected but not modified, the centrifuge is in Preset Lock mode. Press the GEAR button, then the UNLOCK button for 5 seconds. You should now be able to change cycle parameters.</li> </ul>
<p><b>The centrifuge does not unlock after a run is completed</b></p>	<ul style="list-style-type: none"> <li>○ Wait until the rotor has come to a complete stop. If the lid knob still cannot be rotated, press the UNLOCK button and try again.             <ul style="list-style-type: none"> <li>○ If no LED light is on, the unit is not powered, and the lid will not unlock by conventional means. Remove the latch label and use a pen to manually disengage the locking mechanism. Pull the mechanism towards the control panel and then unlatch and open the lid.</li> </ul> </li> <li>○ If the unit is damaged, contact Customer Service for assistance.</li> </ul> 
<p><b>The lid does not open</b></p>	<ul style="list-style-type: none"> <li>○ Ensure that the lid knob is turned fully counterclockwise.</li> <li>○ If the knob cannot be turned counterclockwise, turn it fully clockwise, press UNLOCK, and turn counterclockwise.</li> <li>○ If the lid remains locked after this and will not unlock, the electronics may have been damaged. Contact customer service for assistance.</li> </ul>
<p><b>Clicking noise during braking gets loud</b></p>	<ul style="list-style-type: none"> <li>○ Make sure that the screw in the center of the rotor is tight.</li> </ul>
<p><b>Lid does not stay up</b></p>	<ul style="list-style-type: none"> <li>○ Tighten the center screw on the lid hinge.</li> </ul>

**Contact the professionals at Fiber Optic Center for a quote or to get more details.**

[focenter.com](http://focenter.com) • 508-992-6464 | (800) 473-4237 • [sales@focenter.com](mailto:sales@focenter.com)

23 Centre Street • New Bedford, MA 02740 USA

Product data subject to change without notice. FOC last update 4/22/2026.

## GENERAL SPECIFICATIONS

The rotor and accessories are rated for the maximum rotation frequency shown in the tables below.

	<b>HORIZON 6 Flex</b>	
	For Centrifuge Serial Number containing: YYMM <b>04</b> AA001	For Centrifuge Serial Number containing: YYMM <b>41</b> AA001
<b>Tube Capacity</b>	6 tubes – 3 to 10 mL	
<b>Dimensions (H x W x D)</b>	14 in x 12 in x 9 in (36 cm x 30 cm x 23 cm)	
<b>Weight</b>	12 lbs. (5.4 kg)	
<b>Sound Level</b>	64 dB A	
<b>Supply Voltage</b>	100 – 240 V (+/- 10%)	
<b>Supply Frequency</b>	50 - 60 Hz	
<b>Power Requirement</b>	220 Watts	-
<b>Current Consumption</b>	-	2.2 A at 115 VAC 1.1A at 230 VAC
<b>Centrifuge Motor</b>	½ H.P. Brushless	
<b>Max g-Force</b>	2,100 xg	
<b>Max Speed</b>	3,800 RPM (+/- 100)	
<b>Cycle Time</b>	1 to 30 minutes (+/- 2%)	
<b>Environmental Conditions</b>		
<b>Set-up Site</b>	Indoor Use Only	
<b>Altitude</b>	Up to 2,000m from Sea Level	
<b>Ambient Temperature</b>	5 °C to 40 °C	
<b>Humidity</b>	Maximum relative humidity 80% for temperatures up to 31 °C, decreasing linearly to 50% relative humidity at 40 °C	
<b>Overvoltage Category</b>	II	
<b>Pollution Degree</b>	2	

**Contact the professionals at Fiber Optic Center for a quote or to get more details.**

<b>HORIZON 6 Flex FA</b>	
	For Centrifuge Serial Number containing: YYMM <b>04</b> AA001
	For Centrifuge Serial Number containing: YYMM <b>41</b> AA001
<b>Tube Capacity</b>	6 tubes – 3 to 15 mL
<b>Dimensions (H x W x D)</b>	14 in x 12 in x 9 in (36 cm x 30 cm x 23 cm)
<b>Weight</b>	12 lbs. (5.4 kg)
<b>Sound Level</b>	64 dB A
<b>Supply Voltage</b>	100 – 240 V (+/- 10%)
<b>Supply Frequency</b>	50 - 60 Hz
<b>Power Requirement</b>	220 Watts
<b>Current Consumption</b>	-
<b>Centrifuge Motor</b>	½ H.P. Brushless
<b>Max g-Force</b>	1,650 xg (75 & 100 mm tubes) 1,850 xg (125 mm tubes)
<b>Max Speed</b>	3,900 RPM (+/- 100)
<b>Cycle Time</b>	1 to 30 minutes (+/- 2%)
<b>Environmental Conditions</b>	
<b>Set-up Site</b>	Indoor Use Only
<b>Altitude</b>	Up to 2,000m from Sea Level
<b>Ambient Temperature</b>	5 °C to 40 °C
<b>Humidity</b>	Maximum relative humidity 80% for temperatures up to 31 °C, decreasing linearly to 50% relative humidity at 40 °C
<b>Overvoltage Category</b>	II
<b>Pollution Degree</b>	2

**Contact the professionals at Fiber Optic Center for a quote or to get more details.**

[focenter.com](http://focenter.com) • 508-992-6464 | (800) 473-4237 • [sales@focenter.com](mailto:sales@focenter.com)

23 Centre Street • New Bedford, MA 02740 USA

## CALCULATING THE G-FORCE

The I.F.U.s of tube manufacturers recommend cycles at a minimum G-Force, which can be calculated if you know the RPM and the radius. Use the formula below

In Centimeters:  
$$\text{RCF or G-force} = 0.00001118 \times \text{Rotor Radius (cm)} \times (\text{RPM})^2$$

In Inches:  
$$\text{RCF or G-force} = 0.0000284 \times \text{Rotor Radius (in)} \times (\text{RPM})^2$$

### HORIZON 6 Flex

**Radius** 5 in (12.7 cm)

### HORIZON 6 Flex FA

**Blue Tube (75 & 100 mm)**

3.74 in (9.5 cm)

**Orange Tube (125 mm)**

4.25 in (10.8 cm)



**Contact the professionals at Fiber Optic Center for a quote or to get more details.**

[focenter.com](http://focenter.com) • 508-992-6464 | (800) 473-4237 • [sales@focenter.com](mailto:sales@focenter.com)

23 Centre Street • New Bedford, MA 02740 USA

## REPLACEMENT PARTS

For Centrifuge Serial Number containing: **YYMM04AA001**

Part No.	Description
7724037K	Foot, rubber (Pack of 4)
7786067	Rotor, six-place, Horizontal
7786068	Rotor, six-place, Fixed Angle
02-005-1-0005	Motor Assembly, AC
7729009	Capacitor, 5uF, 250V A.C.
02-006-0-0019	Electronic timing and locking board, AC
7751043	Circuit Breaker
7760006	Power cord
02-004-0-0013	Switch & Power Input Assembly, AC
02-002-1-0027	Lid Assembly
7724071K	Hinge, friction (Pack of 2)
02-002-1-0056	Seal, lid gasket
03-0-0003-0332	Open/Close Label
7713079K	75/100mm Tube Holder, Blue (Pack of 6)
7713044K	125mm Tube Holder, Orange (Pack of 6)
02-002-1-0118K	Kit, Horizon 6 Lid Tray Assy, Blue LED PCBA
03-0-0003-0340	Horizon 6 Flex Front Panel Label
03-0-0003-0354	Horizon 6 Flex FA Front Panel Label
00-100-100-009	6 Series Soft Button Replacement Kit

**Contact the professionals at Fiber Optic Center for a quote or to get more details.**

[focenter.com](http://focenter.com) • 508-992-6464 | (800) 473-4237 • [sales@focenter.com](mailto:sales@focenter.com)

23 Centre Street • New Bedford, MA 02740 USA

For Centrifuge Serial Number containing: **YYMM41AA001**

Part No.	Description
7724037K	Foot, rubber (Pack of 4)
7786067	Rotor, six-place, Horizontal
7786068	Rotor, six-place, Fixed Angle
02-005-1-0010	Motor Assembly, DC
02-006-0-0062	Electronic timing and locking board, DC
7751043	Circuit Breaker
7760006	Power cord
02-002-1-0027	Lid Assembly
7724071K	Hinge, friction (Pack of 2)
02-002-1-0056	Seal, lid gasket
03-0-0003-0332	Open/Close Label
7713079K	75/100mm Tube Holder, Blue (Pack of 6)
7713044K	125mm Tube Holder, Orange (Pack of 6)
02-002-1-0117K	Kit, Dash 6 Lid Tray Assy, Blue LED PCBA
03-0-0003-0340	Horizon 6 Flex Front Panel Label
03-0-0003-0354	Horizon 6 Flex FA Front Panel Label
00-100-100-009	6 Series Soft Button Replacement Kit

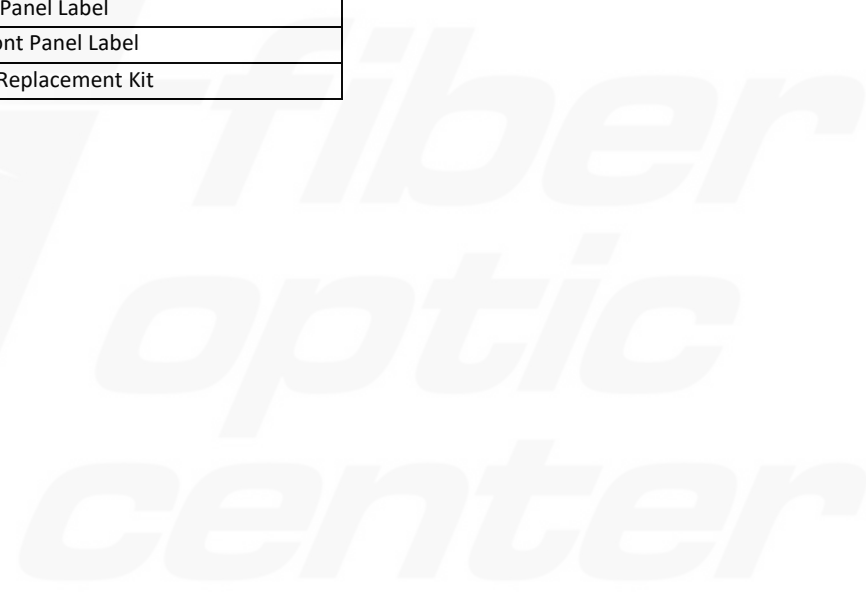

**Contact the professionals at Fiber Optic Center for a quote or to get more details.**

[focenter.com](http://focenter.com) • 508-992-6464 | (800) 473-4237 • [sales@focenter.com](mailto:sales@focenter.com)

23 Centre Street • New Bedford, MA 02740 USA

Product data subject to change without notice. FOC last update 4/22/2026.

This operator's manual is part number 03-0-0002-0138 Rev. H

Product Family: HORIZON Series (HORIZON 6 Flex, 6 Flex FA)

Complies with UL61010-1/CSA C22.2 No. 61010-1 and IEC61010-2-020

Protected by U.S. Patents #6,811,531, # 7,422,554, #D718,463, & #D734,489. Other Patents Pending

**FDA  
LISTED**



#### INSTRUCTIONS FOR DISPOSAL OF WEEE BY USERS IN THE EUROPEAN UNION



This product must not be disposed of with other waste. Instead, it is the user's responsibility to dispose of their waste equipment by handing it over to a designated collection point for the recycling of waste electrical and electronic equipment. The separate collection and recycling of your waste equipment at the time of disposal will help to conserve natural resources and ensure that it is recycled in a manner that protects human health and the environment. For more information about where you can drop off your waste equipment for recycling, please contact your local city office, waste disposal service, or where you purchased the product.



>> [Return to Page 1](#)

**Contact the professionals at Fiber Optic Center for a quote or to get more details.**

[focenter.com](http://focenter.com) • 508-992-6464 | (800) 473-4237 • [sales@focenter.com](mailto:sales@focenter.com)

23 Centre Street • New Bedford, MA 02740 USA

Product data subject to change without notice. FOC last update 4/22/2026.

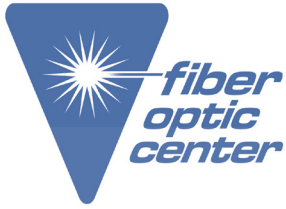

**Manufacturer:**  
Drucker Diagnostics

**Product Name:**  
Drucker Diagnostics HORIZON 6 Flex FA Fixed Angle Routine Centrifuge,  
Digital Display, 10 Preset Cycles, RPM 1000-3800, CE Rated

**Manufacturer Part Number:**  
00-376-009-001

▶ [Click here for more details on the Drucker Diagnostics HORIZON 6 Flex FA Fixed Angle Routine Centrifuge, Digital Display, 10 Preset Cycles, RPM 1000-3800, CE Rated](#)



# **Drucker Diagnostics**

*Innovative Solutions for a Healthier World*

200 Shadylane Drive  
Philipsburg, PA 16866  
[www.druckerdiagnostics.com](http://www.druckerdiagnostics.com)

## **Service Manual**

**HORIZON 6, 6 FA**  
**HORIZON 6 Flex, 6 Flex FA**

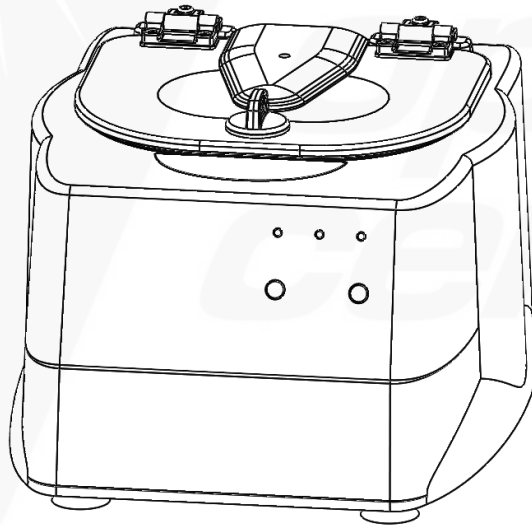

SM024  
REV B

1

[>> Return to Page 1](#)

**Contact the professionals at Fiber Optic Center for a quote or to get more details.**

[focenter.com](http://focenter.com) • 508-992-6464 | (800) 473-4237 • [sales@focenter.com](mailto:sales@focenter.com)

23 Centre Street • New Bedford, MA 02740 USA

Product data subject to change without notice. FOC last update 4/22/2026.

## Contents

1. PREFACE	3
2. GENERAL DESCRIPTION OF MAJOR COMPONENTS	3
4. SPECIFICATIONS	3
5. TROUBLESHOOTING	4
6. SERVICE INSTRUCTIONS	5
7. WIRING DIAGRAM	9
8. SPARE PARTS LIST	10



*fiber  
optic  
center*

SM024  
REV B

2

>> [Return to Page 1](#)

**Contact the professionals at Fiber Optic Center for a quote or to get more details.**

[focenter.com](http://focenter.com) • 508-992-6464 | (800) 473-4237 • [sales@focenter.com](mailto:sales@focenter.com)

23 Centre Street • New Bedford, MA 02740 USA

Product data subject to change without notice. FOC last update 4/22/2026.

## 1. PREFACE

- 1.1. The purpose of this manual is to provide the service technician with information for troubleshooting, testing, and repair of laboratory centrifuge model HORIZON 6, 6 FA, 6 Flex and 6 Flex FA. Only qualified technically trained personnel should attempt any of the servicing described in this document. Failure to follow the procedures in this document may result in personal injury or instrument damage. Drucker Diagnostics will not be held liable for any injury or damage because of improper servicing.
- 1.2. Information contained within this manual is subject to change without notice.

## 2. GENERAL DESCRIPTION OF MAJOR COMPONENTS

- 2.1. Motor: Permanent Split Capacitor AC Motor
- 2.2. Control Board: The control board is the microcontroller-based control center of the centrifuge. All control signals are generated in the control board.
- 2.3. Lid Locking Tray Assembly: The lid tray assembly contains a solenoid and limit switch that are used to determine the state of the lid (Open or Closed) and to keep the lid locked during centrifugation cycles.
- 2.4. Rotor: The centrifuge rotor is the main component that spins in the centrifuge. The rotor is loaded with tube holders, and the samples are placed into the tube holders for processing.

## 4. SPECIFICATIONS

	Horizontal rotor	Fixed-angle rotor
Maximum Speed	3800 RPM	3900 RPM
Maximum RCF	2000 xg	1850 xg
Maximum Capacity	6 Tubes (17 x 100mm)	6 Tubes (17 x 125mm)
Dimensions (in)	9.0 (H) x 12.0 (W) x 14 (L)	
Environmental Operating Range	16-32 deg C	
Typical Noise Level (At Maximum Speed)	< 64 dB A	
Electrical Ratings	115VAC (+/- 10V)	

SM024  
REV B

3

[>> Return to Page 1](#)

**Contact the professionals at Fiber Optic Center for a quote or to get more details.**

[focenter.com](http://focenter.com) • 508-992-6464 | (800) 473-4237 • [sales@focenter.com](mailto:sales@focenter.com)

23 Centre Street • New Bedford, MA 02740 USA

Product data subject to change without notice. FOC last update 4/22/2026.

## 5. TROUBLESHOOTING

PROBLEM	POSSIBLE CAUSE	SOLUTION
The lid does not open.	No power	<ul style="list-style-type: none"> <li>Check line cord</li> <li>Check circuit breaker on underside of centrifuge.</li> <li>Check wall outlet</li> </ul>
	Lid knob is not completely closed	Rotate the lid knob fully clockwise before pressing the 'OPEN' button
	Lid lock is active (Unlock timed out)	Press the 'OPEN' button to de-activate the lid lock
	Lid tray is unplugged from control board or defective	Check wiring
	Control board is damaged	Replace Control board
		To gain access to the rotor - Remove the 'OPEN/CLOSE' sticker and slide the lid latch lever toward the front of the centrifuge. This will unlock the lid.

PROBLEM	POSSIBLE CAUSE	SOLUTION
Excessive vibration	Rotor improperly loaded	Load equally filled tubes symmetrically in the rotor. All carriers and/or tube holders must be present in the rotor.
	Debris lodged within the rotor or tube carriers	Carefully inspect all rotor pockets, tube holders and crevasses for debris, and clean thoroughly.
	Centrifuge housing is loose	Tighten or replace screws
	Missing/damaged feet	Replace feet
	Motor failure	Replace motor
	Rotor damaged	Replace rotor

PROBLEM	POSSIBLE CAUSE	SOLUTION
Rotor does not spin	No Power	<ul style="list-style-type: none"> <li>Check line cord</li> <li>Check circuit breakers on underside of centrifuge.</li> <li>Check wall outlet</li> </ul>
	Lid not properly latched	Press down firmly on lid and rotate lid knob clockwise until the 'LATCHED' light illuminates.
	Internal connection failure	Check wiring
	Control board failure	Replace control board
	Motor Failure	Replace motor

PROBLEM	POSSIBLE CAUSE	SOLUTION
Clicking noise during braking	Rotor is loose	Tighten rotor nut

PROBLEM	POSSIBLE CAUSE	SOLUTION
Whistling noise while running	Debris in air intake / exhaust ports	Remove power before clearing debris.
	Damaged gasket	Requires service

Contact the professionals at Fiber Optic Center for a quote or to get more details.

PROBLEM	POSSIBLE CAUSE	SOLUTION
Cycle ends prematurely: Centrifuge reports the error in a repeating BUZZ / BEEP sequence		
ROTOR BALANCE ERROR: 4 error buzzes + 2 repeating beeps All LEDs blinking in unison with beeps	Rotor improperly loaded	Correct the imbalance
OVERCURRENT ERROR: 4 error buzzes + 3 repeating beeps	Control board, motor, or wiring fault	Check wiring
MOTOR SPEED ERROR: 4 error buzzes + 4 repeating beeps	Rotor motion not detected	<ul style="list-style-type: none"> <li>• Check sensor in lid locking tray assembly</li> <li>• Check reflective tape on rotor</li> </ul>
	Abnormal rotor acceleration detected	Check for missing tube holders
	Motor fails to reach the set speed	<ul style="list-style-type: none"> <li>• Check for missing tube holders</li> <li>• Check the lid and guard bowl gaskets. Voids in the rotor chamber gaskets change the airflow, resulting in increased stress on the motor drive</li> </ul>

## 6. SERVICE INSTRUCTIONS

### 6.1. Cleaning

- The cabinet, rotor and accessories can be cleaned using soap and water, isopropyl alcohol, or a 10% (5500 PPM) bleach solution
- Apply cleaning solutions with a towel or cloth. Do not submerge the centrifuge in water or other cleaning solutions as this will cause damage and void the warranty.
- Under no circumstances should any of the following be used: TBQ Germicidal Products, Fully/Partially Halogenated Hydrocarbons, Ketones or Esters.
- Use of any chemicals not prescribed by the manufacturer may cause damage to the rotor and tube carriers and shall not be used.

### 6.2. Removing the Rotor

- Use a 1/2" nut driver to loosen the center rotor screw (turn counter-clockwise).
- Lift the rotor straight up and out of the rotor chamber.
- To install the rotor, reverse steps A and B above.
- Take care to align the hub spines with the rotor hub.
- Tighten the rotor nut by hand with a 1/2" nut driver until snug. A good rule of thumb is one full thread showing above the nut is a good indicator of proper installation.

### 6.3. Maintaining the Rotor

- Keep the rotor clean, any corrosive materials must not be allowed contact with the rotor and should be cleaned immediately.
- The rotor should be checked periodically for signs of wear.
- Remove the rotor from service if any of the following are found: cracks, deep scratches, corrosion or discoloring.

Contact the professionals at **Fiber Optic Center** for a quote or to get more details.

#### 6.4. **Rotor Nut**

- If the rotor Nut needs to be tightened, use a ½” nut driver and tighten it by hand until snug.
- Rule of thumb: One full thread showing above the nut is a good indicator of proper installation.

#### 6.5. **Speed Calibration**

- Check the centrifuge speed periodically, every two years is recommended.
- Important: When verifying rotor speed, make certain that all carriers are installed in the rotor.
- No calibration adjustment of speed can be made, only a verification of rotor speed.

#### 6.6. **Removing the Cabinet (Upper Housing)**

- There are nine screws that fasten the centrifuge cabinet to the base.
- Begin by unplugging the centrifuge and waiting 10 minutes for internal voltages to dissipate.
- Use a #2 Phillips screwdriver to remove the cabinet screws (six on the bottom, three in the rear)
- The centrifuge control panel is attached to the base internally with cable harnesses. Be careful not to stress the cables when removing the cabinet.
- Lift the cabinet straight up and off the base, setting it down on its front side.
- Gently remove the combination power supply / motor harness from the control board.

#### 6.7. **Replacing the Lid Lock Assembly**

- The lid lock assembly is accessible once the cabinet has been removed.
- Gently remove the lid lock wire harness’ from the control board.
- The lid lock assembly is held in place with four screws.
- Two #8-16 screws on the inside and two #8-32 screws on the outside (covered by the open/close label).
- Remove the Open/Close label to access the two screws underneath.
- To install, line up the holes on the lid tray assembly to the screw holes on the cabinet and install the four screws.
- Complete the installation by plugging the wire harness into the control board header ‘J2’.

**Contact the professionals at Fiber Optic Center for a quote or to get more details.**

### 6.8. Replacing the Control Board

- The control board is accessible once the cabinet has been removed. Make certain that all wire harnesses have been disconnected.
- The control board has capacitors that will remain charged for a period after the centrifuge is unplugged. Make certain to use standard precautions for handling potentially charged capacitors when working with the control board.
- The control board is held in place with six screws. Use a #2 Philips driver to remove the screws. The board is now free to remove.
- To install the control board, make certain that the six posts line up with the holes in the control board and use a # 2 driver to install the screws.

### 6.9. Removing the motor

- Remove the cabinet assembly as previously described.
- Flip the base assembly up-side down and remove the three screws that are securing the exhaust cover and set aside.
- Remove the six screws that hold the guard bowl
- Lift the base assembly off the guard bowl and set it aside
- Disconnect the motor wire connectors.
- Remove the ground connection with a nut driver.
- Flip the guard bowl.
- The motor is held in place with four #8 Nylok nuts. Remove them with an 11/32" nut driver.
- Slide the motor out of the guard bowl's motor well.

**Contact the professionals at Fiber Optic Center for a quote or to get more details.**

[focenter.com](http://focenter.com) • 508-992-6464 | (800) 473-4237 • [sales@focenter.com](mailto:sales@focenter.com)

23 Centre Street • New Bedford, MA 02740 USA

#### 6.10. **Replacing the motor**

- Flip the guard bowl upside down and locate the notch on the bottom.
- Install the motor into the guard bowl with the wires reaching in the same direction as the notch.
- Holding the motor in place, flip the bowl on its side and drive 4 #8 Nylok nuts onto the motor studs with an 11/32" nut driver.
- Turn the guard bowl assembly upside down and position the bowl so the notch is in an 8 o'clock position.
- Place the base assembly onto the guard bowl – make sure the orientation of the motor wires is the same as the image below.

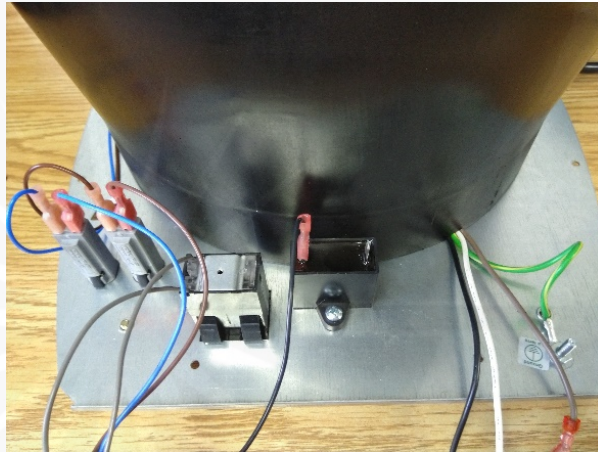

- Make certain that the motor wires are in the notch, and that no wires are pinched between the guard bowl and base.
- Fasten the guard bowl to the base with the six screws, connect the brown wire to the capacitor, ground to the ground stud and the remaining wires black-to-black, white-to-white.

#### 6.11. **Power Connections and Final Assembly**

- Make certain that the lower assembly is unplugged from the mains supply.
- Connect all wiring harnesses to the control board as shown in the wiring diagram in section 8.
- Carefully place the cabinet onto the base taking care not to pinch any wires between the two.
- Complete the assembly by replacing the six screws in the bottom and three in the rear.

SM024  
REV B

8

>> [Return to Page 1](#)

**Contact the professionals at Fiber Optic Center for a quote or to get more details.**

[focenter.com](http://focenter.com) • 508-992-6464 | (800) 473-4237 • [sales@focenter.com](mailto:sales@focenter.com)

23 Centre Street • New Bedford, MA 02740 USA

Product data subject to change without notice. FOC last update 4/22/2026.

## 7. WIRING DIAGRAM

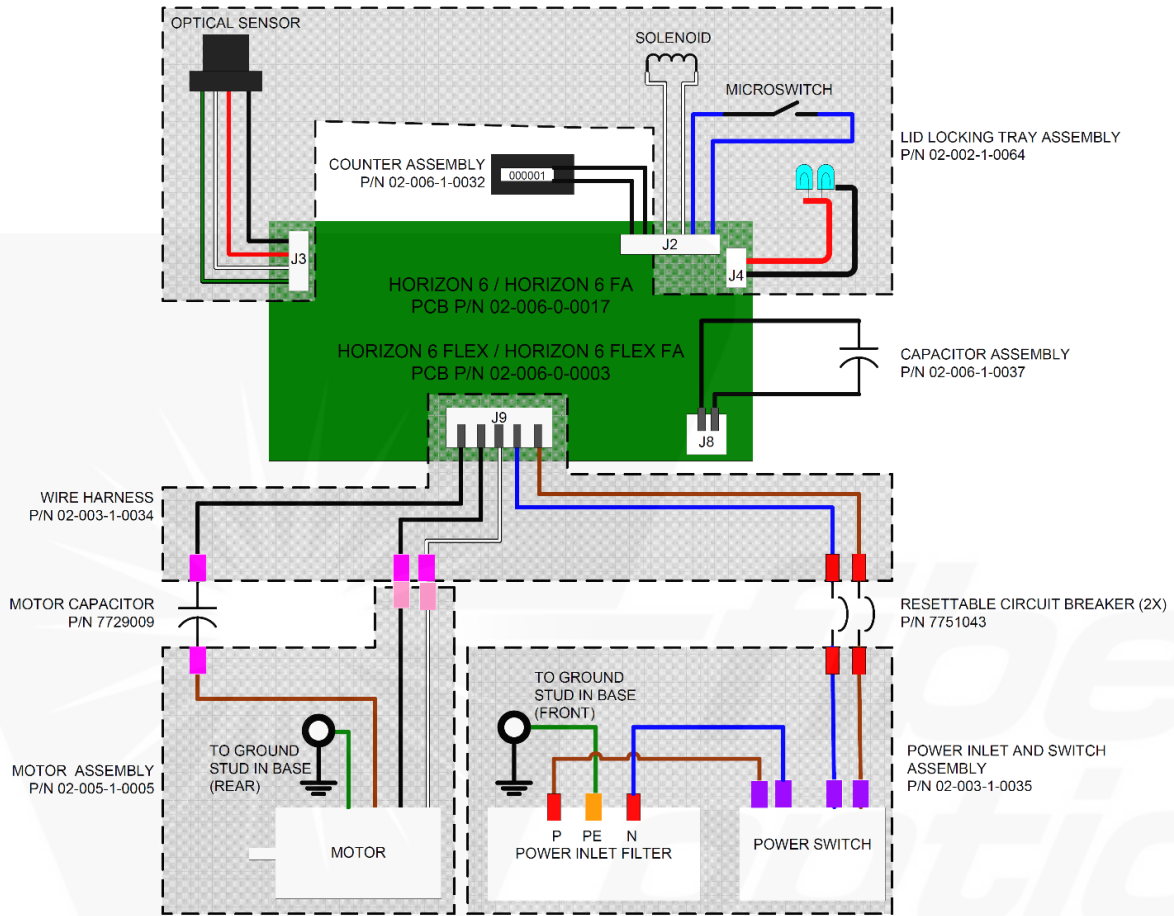

SM024  
REV B

9

>> Return to Page 1

Contact the professionals at Fiber Optic Center for a quote or to get more details.

[focenter.com](http://focenter.com) • 508-992-6464 | (800) 473-4237 • [sales@focenter.com](mailto:sales@focenter.com)

23 Centre Street • New Bedford, MA 02740 USA

Product data subject to change without notice. FOC last update 4/22/2026.

## 8. SPARE PARTS LIST

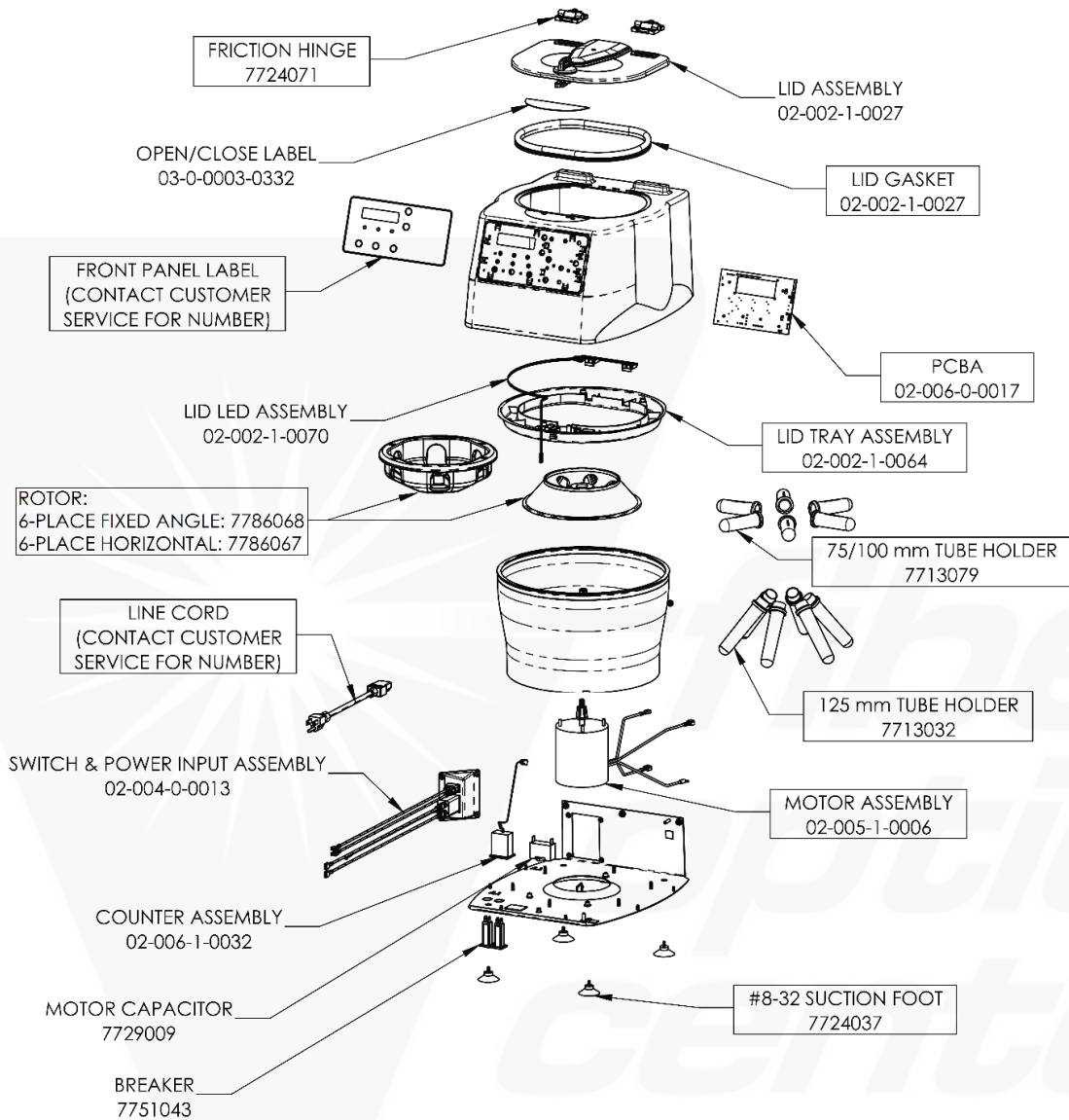

SM024  
REV B

10

>> Return to Page 1

Contact the professionals at Fiber Optic Center for a quote or to get more details.

[focenter.com](http://focenter.com) • 508-992-6464 | (800) 473-4237 • [sales@focenter.com](mailto:sales@focenter.com)

23 Centre Street • New Bedford, MA 02740 USA

Product data subject to change without notice. FOC last update 4/22/2026.