

**Manufacturer:**

Dymax

Product Name:

Dymax Tunnel Light Curtain for 12 inch UV Curing Conveyor Systems

Manufacturer Part Number:

39207

▶ [Click here for more details on the Dymax Tunnel Light Curtain for 12 inch UV Curing Conveyor Systems](#)

UVCS-Series UV Light-Curing Conveyors

12" Wide Conveyor Systems with Multiple Lamp and Part Clearance Options

- Complete UV shielding
- Built-in exhaust fan and stack
- Controlled and consistent cure times
- Integral vacuum hold-down and cooling system
- Accepts parts up to 12" x 36"
- Accurate digital belt control and readout
- 4", 6", or 10" vertical clearance available
- Adjustable lamp-to-belt distance
- 12" belt width (guides available to channel parts into center 6")
- Bench-top conveyor (with optional transportation carrying cart)

The Dymax UVCS series conveyors are designed for curing UV light-curable adhesives, resins, inks, and coatings. These 12" wide conveyors can be outfitted with up to four Dymax 5000-EC lamps or up to two, six-inch microwave lamps. They offer complete shielding from UV light and consistent cure times. The lamp options allow matching intensity requirements to keep operating costs to a minimum. Standard height clearance is 4 inches; optional risers increase clearance to either 6 or 10 inches.

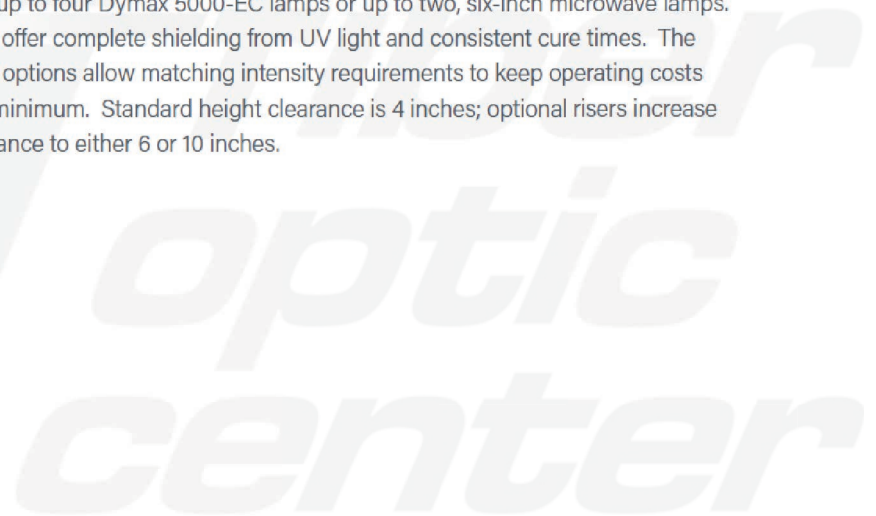

Contact the professionals at Fiber Optic Center for a quote or to get more details.

focenter.com • 508-992-6464 | (800) 473-4237 • sales@focenter.com

23 Centre Street • New Bedford, MA 02740 USA

Product specifications and data are subject to change without notice. FOC last update 3/10/2026.



Manufacturer:
Dymax

Product Name:
Dymax Tunnel Light Curtain for 12 inch UV Curing Conveyor Systems

Manufacturer Part Number:
39207

▶ [Click here for more details on the Dymax Tunnel Light Curtain for 12 inch UV Curing Conveyor Systems](#)

Choosing the Right Lamp(s)

UVCS series conveyors can be outfitted with either 5000-EC lamps or Fusion F300 lamps.

5000-EC Lamps

These lamps provide moderate intensity (~200 mW/cm²) over a 6" x 6" (approximate) curing area. Their 400-Watt auto-switching power supplies accept 90 to 264 Volts AC and 47 to 63 Hz. With normal use, 5000-EC bulbs will retain approximately 90% of their original intensity after 1,000 hours. 5000-EC lamps are recommended for small-to-medium throughput bonding applications. For faster or more tack-free cures, Fusion F300 lamps are recommended.

UVCS series conveyors can be outfitted with one, two, or four 5000-EC lamps as shown in the diagrams below.

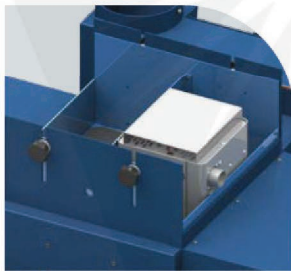

One 5000-EC lamp
center mounted
6" wide single exposure

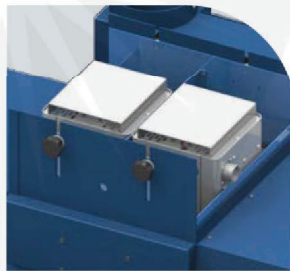

Two 5000-EC lamps
center mounted
6" wide double exposure

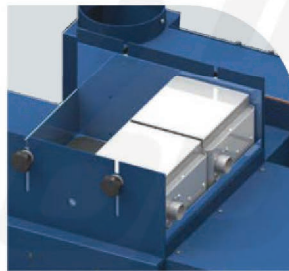

Two 5000-EC lamps
full-width mounted
12" wide single exposure



Four 5000-EC lamps
full-width mounted
12" wide double exposure

Contact the professionals at Fiber Optic Center for a quote or to get more details.

focenter.com • 508-992-6464 | (800) 473-4237 • sales@focenter.com

23 Centre Street • New Bedford, MA 02740 USA

Product specifications and data are subject to change without notice. FOC last update 3/10/2026.

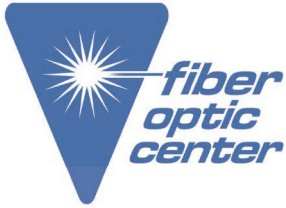

Manufacturer:
Dymax

Product Name:
Dymax Tunnel Light Curtain for 12 inch UV Curing Conveyor Systems

Manufacturer Part Number:
39207

▶ [Click here for more details on the Dymax Tunnel Light Curtain for 12 inch UV Curing Conveyor Systems](#)

Fusion F300 Lamps

These lamps provide the highest intensity (~2,500 mW/cm²) over a 1" x 6" curing area. Fusion F300 lamps require 220/230 Volts AC. With normal use, Fusion F300 lamps retain 80% of their intensity up to 5000 hours. Fusion F300 lamps are recommended for most coating, potting, and gasketing applications and all high throughput applications.

UVCS series conveyors can be outfitted with one or two Fusion F300 lamps as shown in the diagrams below.



UVCS conveyor with one center-mounted Fusion

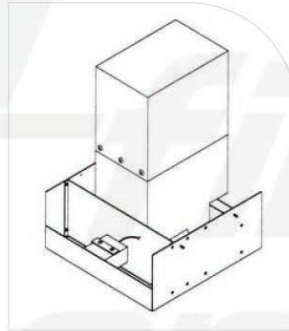

One center-mounted Fusion F300
6" wide single exposure

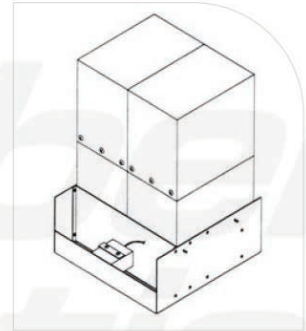

Two full-width mounted
Fusion F300s
2" wide single exposure

Contact the professionals at Fiber Optic Center for a quote or to get more details.

focenter.com • 508-992-6464 | (800) 473-4237 • sales@focenter.com

23 Centre Street • New Bedford, MA 02740 USA

Product specifications and data are subject to change without notice. FOC last update 3/10/2026.



Manufacturer:
Dymax

Product Name:
Dymax Tunnel Light Curtain for 12 inch UV Curing Conveyor Systems

Manufacturer Part Number:
39207

▶ [Click here for more details on the Dymax Tunnel Light Curtain for 12 inch UV Curing Conveyor Systems](#)

Specifications

Replacement Bulbs										
Metal Halide (Standard) 38560	✓	✓	✓	✓	✓	✓	✓	✓	✓	
Mercury 36970**	✓	✓	✓	✓	✓	✓	✓	✓	✓	

**These bulbs are primarily designed for curing UV inks and cationic epoxies.

Overall Dimensions For All UVCS Conveyors

- 50.5" 128 cm long
- 16.4" 42 cm high
- 29.8" 76 cm wide (from control panel to rear of blower)

UVCS conveyors are available without lamps for those customers that have previously purchased 5000-EC or Fusion F300 lamps. Additional lamps may be incorporated into UVCS conveyors after initial purchase (from one or two Fusion lamps, or up to four 5000-ECs). Contact Dymax Application Engineering for configuration assistance.

Contact the professionals at Fiber Optic Center for a quote or to get more details.

focenter.com • 508-992-6464 | (800) 473-4237 • sales@focenter.com

23 Centre Street • New Bedford, MA 02740 USA

Product specifications and data are subject to change without notice. FOC last update 3/10/2026.

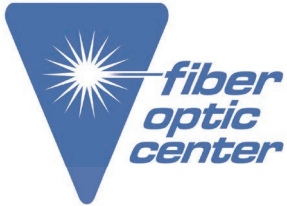

Manufacturer:
Dymax

Product Name:
Dymax Tunnel Light Curtain for 12 inch UV Curing Conveyor Systems

Manufacturer Part Number:
39207

▶ [Click here for more details on the Dymax Tunnel Light Curtain for 12 inch UV Curing Conveyor Systems](#)

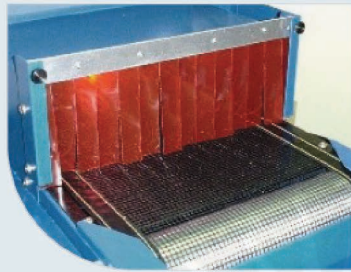

Tunnel Light Curtain



Transportation Cart



Acrylic Tunnel Shield

Replacement Parts & Accessories			
Accessories			
Risers Kit 2" *	Pair		39218
Risers Kit 6" *	Pair		39280
Guides for 6" Curing	1		39277
Transportation Cart	1		39215
Replacement Parts			
Acrylic Tunnel Shield	1		39205
Tunnel Light Curtain	1		39207
5000-EC (for conveyors)	1		39241
Replacement Belt	1		39134

*Available on new conveyors only and installed at the factory.

©2020 Dymax Corporation. All rights reserved. All trademarks in this guide, except where noted, are the property of, or used under license by, Dymax Corporation, U.S.A.
 Please note that most light-curing and dispensing system applications are unique. Dymax does not warrant the fitness of the product for the intended application.
 Dymax recommends that any intended application be evaluated and tested by the user to ensure that desired performance criteria are satisfied. Dymax is willing to assist users in their performance testing and evaluation. Data sheets are available for valve controllers or pressure pots upon request.
 PB073 12/20/2022

Contact the professionals at Fiber Optic Center for a quote or to get more details.

focenter.com • 508-992-6464 | (800) 473-4237 • sales@focenter.com
 23 Centre Street • New Bedford, MA 02740 USA

Product specifications and data are subject to change without notice. FOC last update 3/10/2026.