

INSTRUCTION SHEET



Manufacturer:

Miller®

Product Name:

Miller® MB02-7005 Cable Slitter Tool with Pouch (3-20mm)

Manufacturer Part Number:

MB02-7005

▶ [Click here for more details on the Miller® MB02-7005 Cable Slitter Tool with Pouch \(3-20mm\)](#)

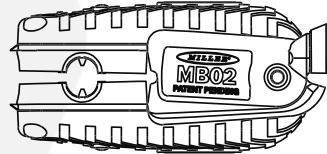

MB02

CABLE SLITTER INSTRUCTION SHEET



LONGITUDINAL CUT

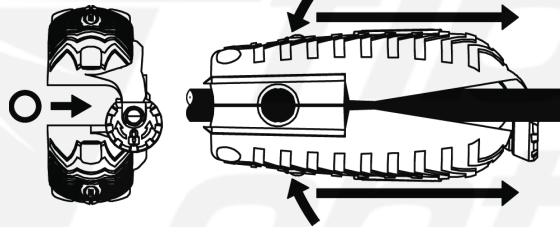

RING CUT

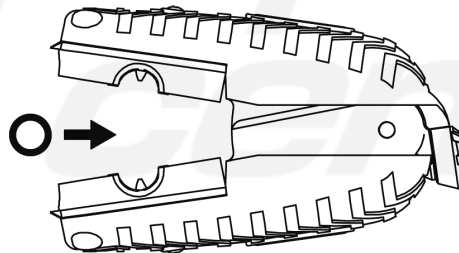

ROTATE 180° AND
BACK 1+ TIMES

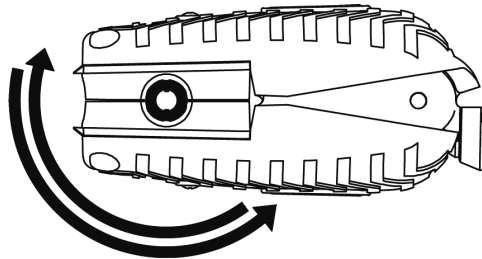

Contact the professionals at Fiber Optic Center for a quote or to get more details.

focenter.com • 508-992-6464 | (800) 473-4237 • sales@focenter.com

23 Centre Street • New Bedford, MA 02740 USA

Data is subject to change without notice. FOC last update 4/27/2026.

TRAY REPLACEMENT

INSERT

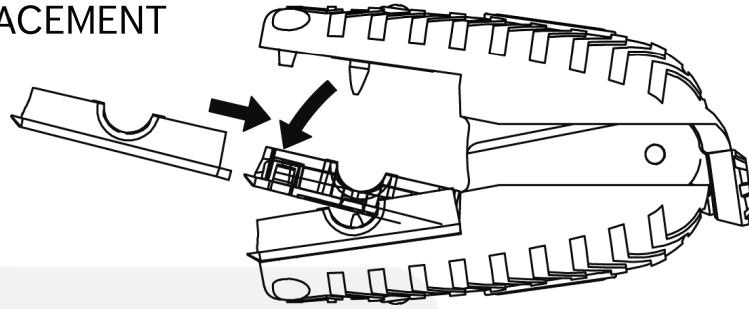

EJECT

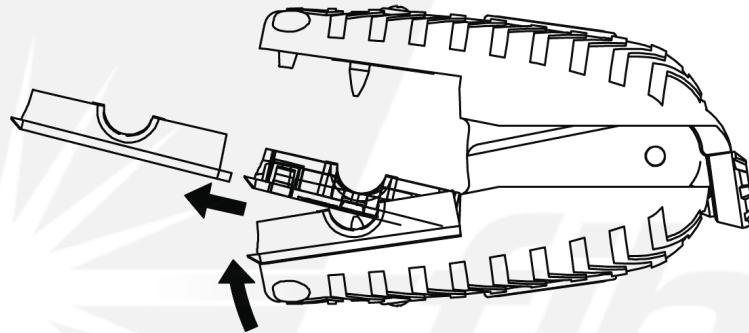

TRAY OVERVIEW

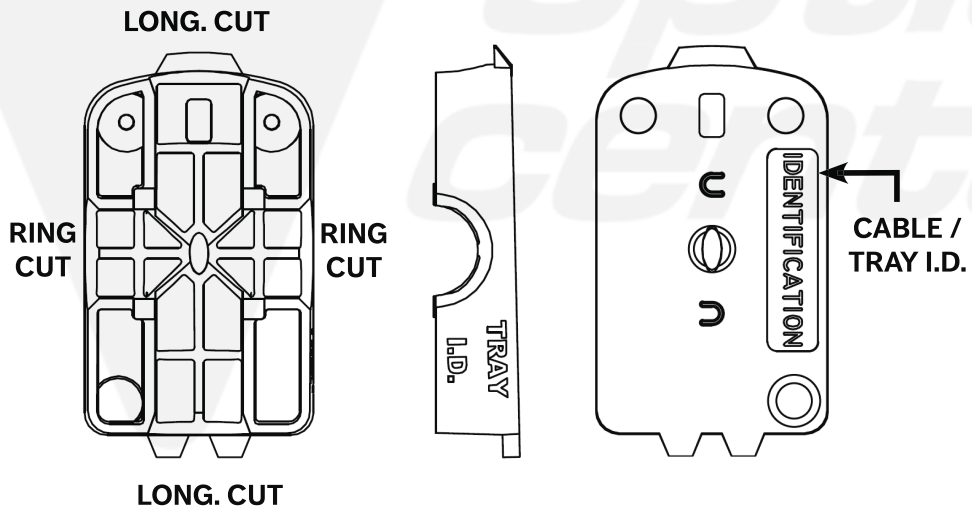

REPLACEMENT BLADE KIT: MB02-7500

WWW.RIPLEY-TOOLS.COM

MB02-6000

Contact the professionals at Fiber Optic Center for a quote or to get more details.

focenter.com • 508-992-6464 | (800) 473-4237 • sales@focenter.com

23 Centre Street • New Bedford, MA 02740 USA

Data is subject to change without notice. FOC last update 4/27/2026.