

USER GUIDE



Manufacturer:

Viavi

Product Name:

Viavi CleanBlastPRO™ Accessory Kit with Camera Clamp, Foot Pedal and Extension Cable Plug

Manufacturer Part Number:

FCLP-ACC-KIT1

▶ [Click here for more details on the Viavi CleanBlastPRO™ Accessory Kit with Camera Clamp, Foot Pedal and Extension Cable Plug](#)

VI.VI

CleanBlastPRO™

Benchtop Fiber End Face Cleaning System

User Guide

22147176 Rev. 105, Standard

November 2020

Contact the professionals at Fiber Optic Center for a quote or to get more details.

focenter.com • 508-992-6464 | (800) 473-4237 • sales@focenter.com

23 Centre Street • New Bedford, MA 02740 USA

Data is subject to change without notice. FOC last update 4/23/2026.

EU CE Marking Directives (LV, EMC, RoHS, RE)

This product conforms with all applicable CE marking directives. Please request the EU Declaration of Conformity for details.

China RoHS materials declaration



6001 America Center Drive, 6th Floor
San Jose, CA 95002, USA

22149383, Rev 000

“中国 RoHS”

《电子信息产品污染控制管理办法》（信息产业部，第 39 号）

附录 (Additional Information required for the Chinese Market only)

本附录按照“中国 RoHS”的要求说明了有关电子信息产品环保使用期限的情况，并列出了产品中含有的有毒、有害物质的种类和所在部件。本附录适用于产品主体和所有配件。

产品系列: CleanBlast Pro
(Product Family)

环保使用期限:



本标识标注于产品主体之上，表明该产品或其配件含有有毒、有害物质（详情见下表）。

其中的数字代表在正常操作条件下至少在产品生产日期之后数年内该产品或其配件内含有的有毒、有害物质不会变异或泄漏。该期限不适用于诸如电池等易耗品。

有关正常操作条件，请参见产品用户手册。

产品生产日期请参见产品的原始校准证书。

有毒、有害物质的类型和所在部件

元器件 (Component)	有毒、有害物质和元素					
	铅(Pb)	汞(Hg)	镉(Cd)	六价铬 (CR ⁶⁺)	多溴联苯 (PBB)	多溴二苯醚 (PBDE)
产品主体 (Main Product)						
印刷电路板组件 (PCB Assemblies)	X	O	X	O	O	O
内部配线 (Internal wiring)	X	O	O	O	O	O
显示器 (Display)	X	O	O	O	O	O
键盘 (Keyboard)	O	O	O	O	O	O
电池 (Batteries)	O	O	O	O	O	O
电源 (Power Supply)	X	O	O	O	O	O
电工零件 (Electro-mechanical parts)	X	O	O	O	O	O
硬盘 (Hard Drive)	O	O	O	O	O	O
光模块/辅助模块 (Optical modules) / (Auxiliary modules)	X	O	O	O	O	O
金属外壳零件和紧固件 (Metal case parts and fixings)	X	O	O	O	O	O
塑料外壳零件 (Plastic case parts)	O	O	O	O	O	O
标签和胶带 (Labels and tapes)	O	O	O	O	O	O
配件 (Accessories)						
外接电缆和适配器 (External cables and adapters)	X	O	O	O	O	O
CD ROMS						
手册和其它印刷材料 (Handbooks and other printed material)	O	O	O	O	O	O
包装箱和绑带 (Carrying case and strap)	O	O	O	O	O	O
其它配件 (Other accessories)	O	O	O	O	O	O

本表是按照 S / T 11364 的规定编制的:

O: 表示该有害物质在该部件所有均质材料中的含量均在 GB/T 26572 规定的限量要求以下。

X: 表示该有害物质至少在该部件的某一均质材料中的含量超出 GB/T 26572 规定的限量要求。

Contact the professionals at Fiber Optic Center for a quote or to get more details.

focenter.com • 508-992-6464 | (800) 473-4237 • sales@focenter.com

23 Centre Street • New Bedford, MA 02740 USA

Data is subject to change without notice. FOC last update 4/23/2026.

Contents

1 CleanBlastPRO™ Benchtop Fiber End Face Cleaning System	1-1
Key features	1-2
Ordering information	1-3
FCLT Series cleaning tips	1-4
Safety	1-4
Technical Assistance Center and Knowledge Base	1-4
2 Getting started	2-1
CleanBlastPRO features	2-2
Indicators and menu navigation	2-4
Handset features and mounting	2-5
Mounting the CleanBlastPRO on a cart or dolly	2-6
Work station requirements	2-6
Powering the CleanBlastPRO	2-7
Powering on	2-7
Powering off	2-7
Connecting or disconnecting an air source	2-8
Connecting an air source	2-8
Disconnecting the air source	2-8
Filling the solvent tank	2-9
Performing a manual refill	2-9
Performing an auto refill	2-12
Configuring custom cleaning profiles	2-15
Handset operation	2-17
Modifying handset settings	2-17
Foot pedal operation	2-18
Connecting an FCLT Series cleaning tip to the handset	2-18
3 Fiber cleaning	3-1
Before you begin cleaning	3-2
Priming the handset	3-2
Performing a cleaning cycle	3-3
Performing a regular cleaning cycle	3-3
Performing an extended cleaning cycle	3-3
4 Maintenance	4-1
Setting up the CleanBlastPRO with a check valve and pressure tank	4-2
Replacing air filters	4-3
Replacing the fine and coarse air filters	4-3
Replacing the air filter on the CleanBlastPRO Auto Refill Kit	4-5
Auto-drain valves	4-6

Contact the professionals at Fiber Optic Center for a quote or to get more details.

focenter.com • 508-992-6464 | (800) 473-4237 • sales@focenter.com

23 Centre Street • New Bedford, MA 02740 USA

Data is subject to change without notice. FOC last update 4/23/2026.

Draining the solvent	4-7
Preparing the CleanBlastPRO for transportation/shipping	4-9
Accessing system settings and information.....	4-10
Updating the CleanBlastPRO firmware.....	4-11
Generating the firmware file.....	4-11
Updating the firmware.....	4-12
Exporting the log file.....	4-13
Appendix A CleanBlastPRO menu summary	A-1
Menu icons	A-2
VIAVI Menu.....	A-2
Main Menu	A-3
Select Profile and Edit:CUSTOM	A-3
Fluid/Tank Menu	A-4
Current Warnings	A-4
System Settings	A-5
Appendix B Specifications	B-1
Appendix C Custom profile examples	C-1
Example 1 - Basic Clean	C-2
Example 2: Basic Clean - Two Cycles.....	C-3
Example 3: Blow/Vac Then Clean	C-4

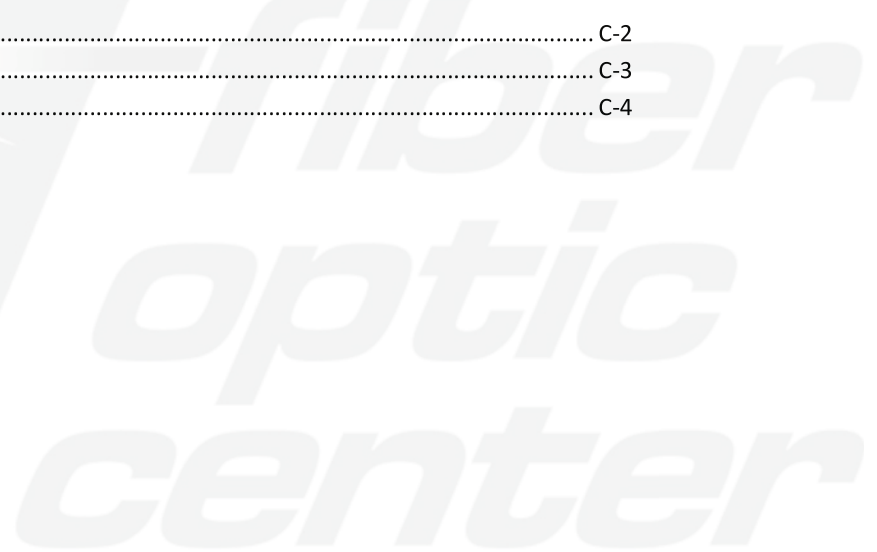

Contact the professionals at Fiber Optic Center for a quote or to get more details.

focenter.com • 508-992-6464 | (800) 473-4237 • sales@focenter.com

23 Centre Street • New Bedford, MA 02740 USA

Data is subject to change without notice. FOC last update 4/23/2026.



About this guide

This guide provides information about the CleanBlastPRO™ Benchtop Fiber End Face Cleaning System.

Revision history

Revision	Date	Details
105	November 2020	<ul style="list-style-type: none">Updated front matter content:<ul style="list-style-type: none">Added patent informationReplaced China RoHS materials declarationUpdated the following sections:<ul style="list-style-type: none">“Ordering information”“Performing a manual refill”“Performing an auto refill”“Foot pedal operation”“Generating the firmware file”“Updating the firmware”“Exporting the log file”
104	October 2020	<ul style="list-style-type: none">Updated the following information:<ul style="list-style-type: none">Admonitions regarding solvent useSpecificationsURLs to access this user guide and the CleanBlastPRO Firmware USB Flash Drive CreatorAdded the section “Preparing the CleanBlastPRO for transportation/shipping”
103	August 2020	Assigned new document part number.
102	August 2020	Document formatting changes.
101	July 2020	Document formatting changes.
100	July 2020	This document is released.

To access the latest version of this user guide, go to:

http://cbpro.updatemyunit.net/archives/CBPRO/User_Guide_CleanBlastPRO.pdf

Contact the professionals at Fiber Optic Center for a quote or to get more details.

focenter.com • 508-992-6464 | (800) 473-4237 • sales@focenter.com

23 Centre Street • New Bedford, MA 02740 USA

Data is subject to change without notice. FOC last update 4/23/2026.

1 CleanBlastPRO™ Benchtop Fiber End Face Cleaning System

The CleanBlastPRO Benchtop Fiber End Face Cleaning System is an automated, easy-to-deploy fiber connector cleaning system that features an internal solvent tank, air filtration system, cleaning handset with 2-meter (6.5 foot) umbilical, and an LCD screen. The device provides users with an intuitive cleaning system, offering cleaning profiles optimized for Simplex and MPO fiber connectors.

Also, the CleanBlastPRO supports a comprehensive selection of precision cleaning tips for most fiber connector types, with both male (patch cord) and female (bulkhead) connectors, including SC, LC, FC, ST, E2000, MPO, MPX, MT, and SMA. With backwards compatibility to the large selection of FCLT series tips, users of CleanBlast™ cleaning systems can leverage their existing investment of cleaning tips.

Figure 1-1: CleanBlastPRO Benchtop Cleaning System with FCLT Series cleaning tip



This section covers the following information:

- “Key features” on page 1-2
- “Ordering information” on page 1-3
- “FCLT Series cleaning tips” on page 1-4
- “Safety” on page 1-4
- “Technical Assistance Center and Knowledge Base” on page 1-4

Contact the professionals at Fiber Optic Center for a quote or to get more details.

focenter.com • 508-992-6464 | (800) 473-4237 • sales@focenter.com

23 Centre Street • New Bedford, MA 02740 USA

CleanBlastPRO™ Benchtop Fiber End Face Cleaning System
Key features

Key features

- Supports use of the following cleaning solutions:
 - 3M™ Novec™ 72DA, a superior, nonflammable, highly cost effective cleaning solvent for fiber end faces
 - CleanBlast Solvent from MicroCare® Corporation, which is identical to the Novec 72DA solvent
- Provides factory-defined cleaning profiles optimized for Simplex and MPO connectors, and supports up to five user-defined custom cleaning profiles for specific applications
- Onboard self-diagnostics ensure consistent operation in mission critical applications
- Active fluid vapor vacuum system with vacuum pull greater than fluid and air pressure keeps fumes away from operator
- Sealed fluid reservoir and fill system ensure that contaminants are not deposited by the cleaning system
- Automatic drain valves in air-filter canisters prevent water in the air/gas supply from contaminating the system



*fiber
optic
center*

Contact the professionals at Fiber Optic Center for a quote or to get more details.

focenter.com • 508-992-6464 | (800) 473-4237 • sales@focenter.com

23 Centre Street • New Bedford, MA 02740 USA

Data is subject to change without notice. FOC last update 4/23/2026.

Ordering information

Table 1-1: CleanBlastPRO Benchtop Fiber End Face Cleaning System part numbers

Component	Part Number
CleanBlastPRO Benchtop Cleaning System Benchtop with Large Tank	FCL-PRO-L
Accessories	
CleanBlastPRO Manual Refill Kit for 225 ml Solvent Refill Bottle	FCLP-RCA-2
CleanBlastPRO Auto Refill Kit for 3.75 L Solvent Refill Bottle	FCLP-RCA-3
Replacement Air Filter for CleanBlastPRO Auto Refill Kit (FCLP-RCA-3), 1- Pack	FCLP-FA-F1
Solvent Refill (3M Novec 72DA ¹), 225 ml Bottle ²	FCLP-SOL1
Solvent Refill (3M Novec 72DA) 6-pack, 225 ml Bottle ²	FCLP-SOL1-6
Solvent Refill (3M Novec 72DA), 3.75 L Bottle ³	FCLP-SOL1-XL
Exhaust Filter Kit for Bench-Top CleanBlast Systems	FCLP-FE-01
Replacement Large Coarse Air Filter for CleanBlastPRO, 2-Pack	FCLP-FA-F2
Replacement Large Fine Air Filter for CleanBlastPRO, 2-Pack	FCLP-FA-F3
Cleaning Tips	See "FCLT Series cleaning tips" on page 1-4.
Adjustable Articulating Camera Clamp for use with CleanBlastPRO	FCLP-CL-01
Foot Pedal SPDT-NO Black 3A 30VAC 8 Foot Cord for use with CleanBlastPRO	FCLP-FP-01
Extension Cable ¼" Plug for use with FCLP-FE-01 and CleanBlastPRO	FCLP-EC-01
CleanBlastPRO Accessory Kit (contains FCLP-CL-01, FCLP-FP-01, and FCLP-EC-01)	FCLP-ACC-KIT1

1. CleanBlastPRO is rated for use with 3M Novec 72DA Engineered Fluid. Use only Novec 72DA solvent from 3M or CleanBlast solvent from MicroCare Corporation (identical formulation to Novec 72DA). Warranty will be void if a VIAVI repair center or representative determines that any other solvent has been used and is the cause of operational problems.
2. For use with FCLP-RCA-2 only.
3. For use with FCLP-RCA-3 only.

Contact the professionals at Fiber Optic Center for a quote or to get more details.

focenter.com • 508-992-6464 | (800) 473-4237 • sales@focenter.com

23 Centre Street • New Bedford, MA 02740 USA

CleanBlastPRO™ Benchtop Fiber End Face Cleaning System
FCLT Series cleaning tips

FCLT Series cleaning tips

The CleanBlastPRO supports a wide range of FCLT Series cleaning tips to suit any application. [Table 1-2](#) lists the cleaning tips used for the most common applications. For a full listing of available cleaning tips, see the [Fiber Cleaning Tips and Adapters Selection Guide](#).

Table 1-2: FCLT Series cleaning tips for common applications

Connector Type		Cleaning Tip Part Number
FC	Bulkhead	FCLT-U25 or FCLT-FC-250
	Patch Cord	FCLT-U25 + FCLT-U25-MA
LC	Bulkhead	FCLT-U12 or FCLT-LC
	Patch Cord	FCLT-U12 + FCLT-U12-MA
SC	Bulkhead	FCLT-U25 or FCLT-SC-250
	Patch Cord	FCLT-U25 + FCLT-U25-MA
ST	Bulkhead	FCLT-U25
	Patch Cord	FCLT-U25 + FCLT-U25-MA
MPO	Bulkhead	FCLT-MTP
	Patch Cord	FCLT-MTP + FCLT-MTP-MA

Safety



CAUTION

Turn off the device and disconnect all cables connected to it before moving the device.

Contact the professionals at Fiber Optic Center for a quote or to get more details.

focenter.com • 508-992-6464 | (800) 473-4237 • sales@focenter.com

23 Centre Street • New Bedford, MA 02740 USA



2 Getting started

This section covers the following information:

- “CleanBlastPRO features” on page 2-2
- “Work station requirements” on page 2-6
- “Powering the CleanBlastPRO” on page 2-7
- “Connecting or disconnecting an air source” on page 2-8
- “Filling the solvent tank” on page 2-9
- “Configuring custom cleaning profiles” on page 2-15
- “Handset operation” on page 2-17
- “Foot pedal operation” on page 2-18
- “Connecting an FCLT Series cleaning tip to the handset” on page 2-18

*fiber
optic
center*

Contact the professionals at Fiber Optic Center for a quote or to get more details.

[focenter.com](https://www.focenter.com) • 508-992-6464 | (800) 473-4237 • sales@focenter.com

23 Centre Street • New Bedford, MA 02740 USA

Data is subject to change without notice. FOC last update 4/23/2026.

Getting started
CleanBlastPRO features

CleanBlastPRO features

Figure 2-1: CleanBlastPRO - front



Figure 2-2: CleanBlastPRO - rear

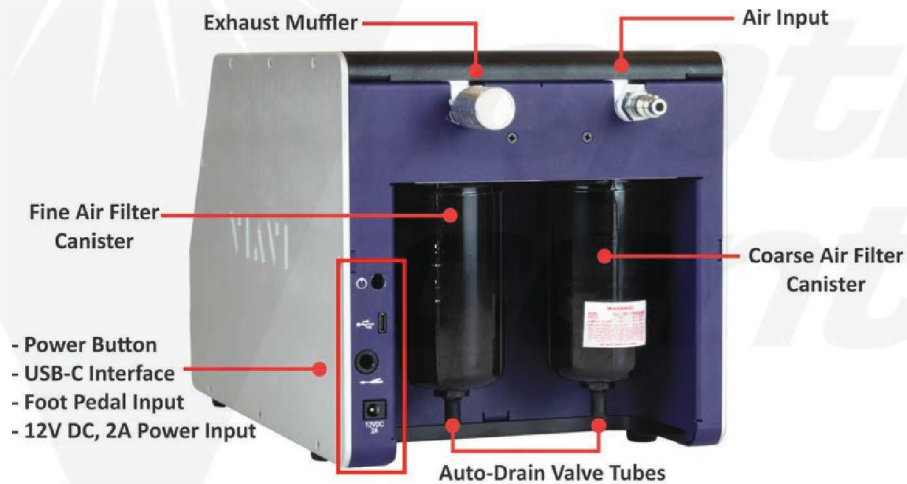

Contact the professionals at Fiber Optic Center for a quote or to get more details.

focenter.com • 508-992-6464 | (800) 473-4237 • sales@focenter.com

23 Centre Street • New Bedford, MA 02740 USA

Data is subject to change without notice. FOC last update 4/23/2026.

Figure 2-3: CleanBlastPRO - underside

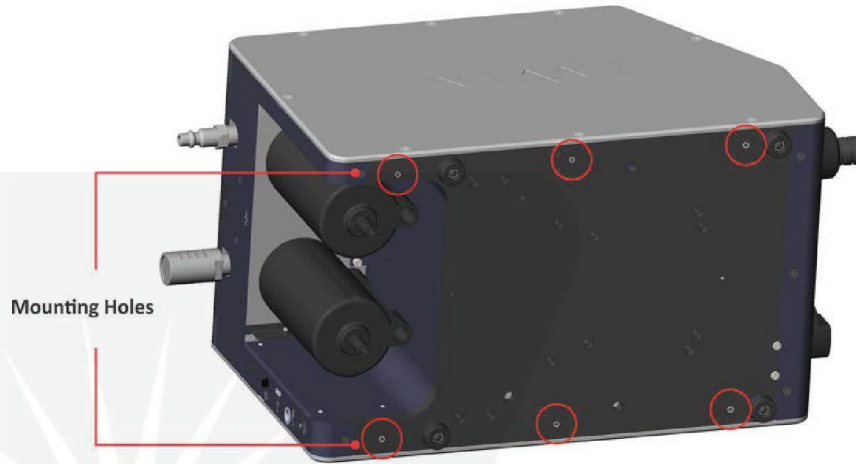

Feature	See...
Dial and Indicators	"Indicators and menu navigation" on page 2-4
Refill Port Cover	"Filling the solvent tank" on page 2-9
Handset	<ul style="list-style-type: none"> "Handset features and mounting" on page 2-5 "Handset operation" on page 2-17
Air Input	"Connecting or disconnecting an air source" on page 2-8
Fine and Coarse Air Filters	"Replacing air filters" on page 4-3
Power Button, Power Input	"Powering the CleanBlastPRO" on page 2-7
USB-C Interface	<ul style="list-style-type: none"> "Updating the CleanBlastPRO firmware" on page 4-11 "Exporting the log file" on page 4-13
Foot Pedal Input	"Foot pedal operation" on page 2-18
Auto-drain Valves	"Auto-drain valves" on page 4-6
Mounting Holes	"Mounting the CleanBlastPRO on a cart or dolly" on page 2-6

Contact the professionals at Fiber Optic Center for a quote or to get more details.

focenter.com • 508-992-6464 | (800) 473-4237 • sales@focenter.com

23 Centre Street • New Bedford, MA 02740 USA

Getting started
CleanBlastPRO features

Indicators and menu navigation

Figure 2-4: Indicators and CleanBlastPRO menu navigation



LCD Screen	Displays the CleanBlastPRO menu, operation and status information, and error messages related to maintenance issues. See “CleanBlastPRO menu summary” on page A-1.
Dial	<ul style="list-style-type: none"> • Rotate to scroll the CleanBlastPRO menu displayed on the LCD screen or to highlight a setting to be selected. • Click (press and release quickly) to select a menu option or setting. • Press and hold down for certain operations.
Ready LED	Lights (green) to indicate that the CleanBlastPRO is powered on and ready to operate.
Busy LED	Lights (yellow) to indicate that the CleanBlastPRO is performing an operation (e.g., cleaning cycle, depressurization, fluid fill, firmware update, etc.).
Maintenance LED	<ul style="list-style-type: none"> • Lights yellow to indicate the presence of a condition that does not impact normal operation. • Lights red to indicate the presence of a condition that prevents normal operation; handset buttons and foot pedal are disabled while condition is present.
Fluid Gauge	Number and color of lit LED components indicate the solvent level: <ul style="list-style-type: none"> • Five (5) blue LEDs: 81 to 100% full • Four (4) blue LEDs: 61 to 80% full • Three (3) blue LEDs: 41 to 60% full • Two (2) blue LEDs: 21 to 40% full • One (1) blue LED: 11 to 20% full • One (1) yellow LED: 1 to 10% full, fluid low - refill • One (1) red LED: Empty (handset is disabled)

Contact the professionals at Fiber Optic Center for a quote or to get more details.

focenter.com • 508-992-6464 | (800) 473-4237 • sales@focenter.com

23 Centre Street • New Bedford, MA 02740 USA

Handset features and mounting

In addition to the cleaning tip base and configurable buttons for operation, the handset features an onboard flashlight and a standard 1/4-20 tripod mount. For information about configuring handset operation, including button operation, see “Handset operation” on page 2-17.

Figure 2-5: CleanBlastPRO handset features

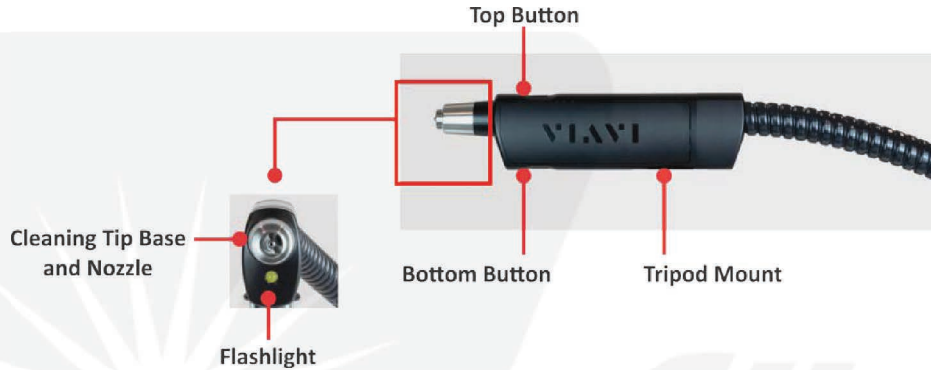

For mounting the handset, VIAVI recommends using the DF Digitalfoto Adjustable Articulating Camera Clamp.

Figure 2-6: Mounted handset



Contact the professionals at Fiber Optic Center for a quote or to get more details.

focenter.com • 508-992-6464 | (800) 473-4237 • sales@focenter.com

23 Centre Street • New Bedford, MA 02740 USA

Getting started
Work station requirements

Mounting the CleanBlastPRO on a cart or dolly

The underside of the CleanBlastPRO features six threaded (M4X0.7-6H) mounting holes for securing the device to a cart or dolly if required. VIAVI recommends using a cart or dolly similar to the SafTcart™ MC-61H Running Gear/Boxcart.

Figure 2-7: CleanBlastPRO underside - threaded (M4X0.7-6H) mounting holes

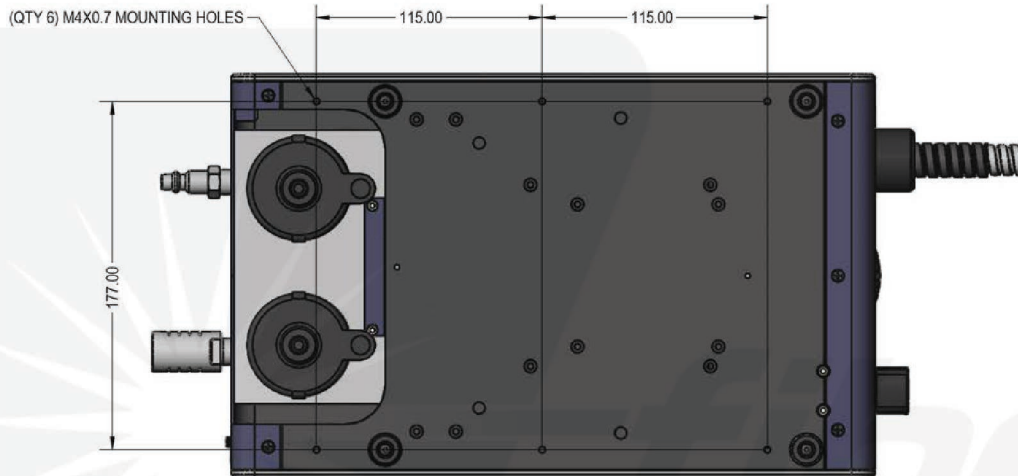

Note: Maximum penetration of screws to mount the device is 13 mm (0.51 inches) measured from the underside of the device. The rubber feet can be removed from the CleanBlastPRO if required.

Work station requirements

Ensure that the CleanBlastPRO is stationed on a level, stable surface and that the following resources are within easy reach of the device:

- An appropriate power source (see “Powering the CleanBlastPRO” on page 2-7)
- An appropriate air source (see “Connecting or disconnecting an air source” on page 2-8)

Contact the professionals at Fiber Optic Center for a quote or to get more details.

focenter.com • 508-992-6464 | (800) 473-4237 • sales@focenter.com

23 Centre Street • New Bedford, MA 02740 USA

Powering the CleanBlastPRO



CAUTION

Use only the power adapter shipped with the CleanBlastPRO to power the device.

Powering on

- Step 1 Ensure that the refill port cover is closed (see [Figure 2-1 on page 2-2](#)).
- Step 2 At the rear of the device (see [Figure 2-2 on page 2-2](#)), do the following:
- Connect the power adapter provided with the CleanBlastPRO to the power input and then to the power source.
 - Press and hold the power button for two (2) seconds.
- Step 3 Observe the following sequence on the front panel of the CleanBlastPRO:
- All LEDs light momentarily.
 - Fluid gauge LEDs light to indicate solvent level in tank.
 - Ready or Maintenance LED lights, depending on the status of the device (see [“Current Warnings” on page A-4](#)).
 - The **VIAMI** menu appears on the LCD screen.

— End —

Powering off

- Step 1 Press and hold the power button for two (2) seconds.
- Step 2 Observe the following sequence at the front panel:
- Lit indicators turn off.
 - LCD screen turns off.

Important: Always use the power button to power off the CleanBlastPRO. Avoid disconnecting the power cord while the device is powered on.

— End —

Contact the professionals at Fiber Optic Center for a quote or to get more details.

focenter.com • 508-992-6464 | (800) 473-4237 • sales@focenter.com

23 Centre Street • New Bedford, MA 02740 USA

Getting started
Connecting or disconnecting an air source

Connecting or disconnecting an air source

Use any of the following air sources with the CleanBlastPRO:

- Compressed *shop air* (ISO8573 Class 5 - Clean Dry Air. Oil less than 25mg/m**3)
- Oil-free portable air compressor. VIAVI recommends the Metabo HPT® Ultra Quiet EC28M Portable Air Compressor.
- Nitrogen (N₂) tank, regulated down to 100 psi



CAUTION

For any air source, ensure that the air/gas pressure is within 80 to 140 psi (100 psi nominal), which is the operational range of the CleanBlastPRO (see “Specifications” on page B-1).

Important: See “Setting up the CleanBlastPRO with a check valve and pressure tank” on page 4-2 for information about ensuring consistent air pressure whenever the CleanBlastPRO must share an air source with other equipment.

Connecting an air source

- Step 1 Ensure that the refill port cover is closed (see Figure 2-1 on page 2-2).
- Step 2 Insert the connector straight into the air input of the CleanBlastPRO, and then secure it.



If the CleanBlastPRO is powered on and the air source is properly connected to the device, the Ready LED lights and the **VIAVI** menu appears on the LCD screen.

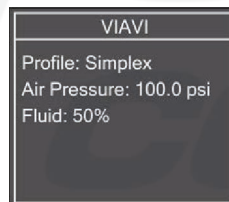

Note: If the Maintenance LED lights, navigate to the **Current Warnings** menu on the LCD screen for information (see “Current Warnings” on page A-4).

— End —

Disconnecting the air source

- Step 1 Pull back on the spring-loaded locking mechanism of the air source connector.
- Step 2 Pull the connector straight off the air input.

— End —

Contact the professionals at Fiber Optic Center for a quote or to get more details.

focenter.com • 508-992-6464 | (800) 473-4237 • sales@focenter.com

23 Centre Street • New Bedford, MA 02740 USA

Filling the solvent tank

The CleanBlastPRO supports both manual and automatic refilling of its internal solvent tank, and provides a contaminant-free connection between the solvent bottle and the tank to prevent contamination of the solvent tank during refill.

Ensure that you have the correct refill kit and correct bottle size of 3M Novec 72DA or CleanBlast solvent for the type of refill operation you want to use. See “[Ordering information](#)” on page 1-3 for more information.

Important:

- CleanBlastPRO is rated for use with 3M Novec 72DA Engineered Fluid. Use only Novec 72DA solvent from 3M or CleanBlast solvent from MicroCare Corporation (identical formulation to Novec 72DA). Warranty will be void if a VIAVI repair center or representative determines that any other solvent has been used and is the cause of operational problems..
- Store each refill kit in a contaminant-free zipper locking bag between uses.

Performing a manual refill



WARNING

Read this procedure in full before you begin. Do not attempt to connect the refill kit to the CleanBlastPRO until the device has completely depressurized.

- Step 1 Ensure that the CleanBlastPRO is powered on.
- Step 2 Install the CleanBlastPRO Manual Refill Kit (FCLP-RCA-2) assembly onto a 225-ml bottle of solvent.



Contact the professionals at Fiber Optic Center for a quote or to get more details.

focenter.com • 508-992-6464 | (800) 473-4237 • sales@focenter.com

23 Centre Street • New Bedford, MA 02740 USA

Getting started
Filling the solvent tank

Step 3 At the front of the CleanBlastPRO, rotate the refill port cover counterclockwise.

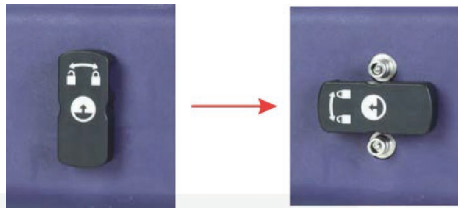

Depressurization of the CleanBlastPRO begins immediately. Observe the message and count-down timer that appear on the LCD screen and wait for depressurization to complete.

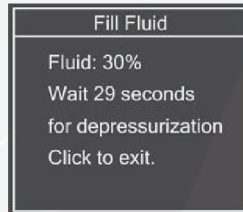

Step 4 Ensure that depressurization is completed.
The following message appears on the LCD screen.

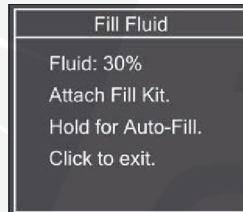

Step 5 Orient the fill connector on the refill assembly so that the marking TOP on the top lever is facing up, press the top and bottom levers on the fill connector, and then connect the fill connector to the refill port on the CleanBlastPRO.

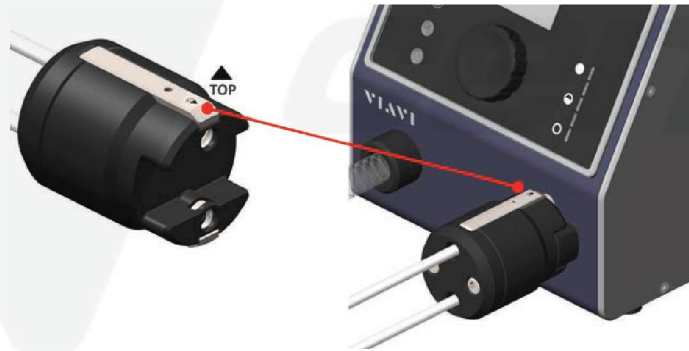

Contact the professionals at Fiber Optic Center for a quote or to get more details.

focenter.com • 508-992-6464 | (800) 473-4237 • sales@focenter.com

23 Centre Street • New Bedford, MA 02740 USA

- Step 6 Invert the bottle of solvent upside down and hold it above the refill port so that the solvent drains into the tank.



Note: Do not press or click the dial on the CleanBlastPRO during the manual refill operation.

Important: Ensure that the fill connector remains steady while in use. Bumping or jostling the connector during refill can cause solvent to leak from the fittings.

- Step 7 Observe the LCD screen, the fluid gauge, and the contents of the bottle.
The solvent will automatically stop draining from the bottle when the solvent tank is full and the fluid gauge indicates 100%.
- Step 8 When the solvent is at the required level, set the bottle down right side up.
- Step 9 Press the top and bottom levers on the fill connector, and then carefully pull back the fill connector to disconnect it from the CleanBlastPRO.
- Step 10 Rotate the refill port cover clockwise to close it.

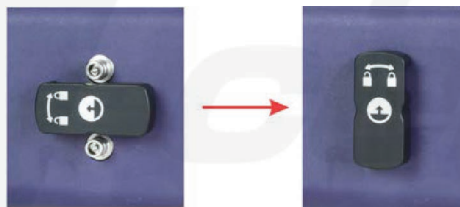

- Step 11 Remove the refill kit assembly from the bottle of solvent, and store it in a contaminant-free zipper locking bag.

Important: If you choose to leave the refill kit assembly installed on the bottle of solvent, ensure that the fill connector is wrapped and that the assembly and bottle are stored in a contaminate-free manner.

— End —

Contact the professionals at Fiber Optic Center for a quote or to get more details.

focenter.com • 508-992-6464 | (800) 473-4237 • sales@focenter.com

23 Centre Street • New Bedford, MA 02740 USA

Getting started
Filling the solvent tank

Performing an auto refill



WARNING

Read this procedure in full before you begin. Do not attempt to connect the refill kit to the CleanBlastPRO until the device has completely depressurized.

- Step 1 Ensure that the CleanBlastPRO is powered on.
- Step 2 Install the refill kit assembly onto the bottle of solvent by tightly securing the cap connector to the bottle.

Note: The cap connector contains a replaceable 0.1 micron air filter to ensure that air flowing into the bottle is clean and free of contaminants. For more information, see “Replacing the air filter on the CleanBlastPRO Auto Refill Kit” on page 4-5.



- Step 3 At the front of the CleanBlastPRO, rotate the refill power cover counterclockwise.

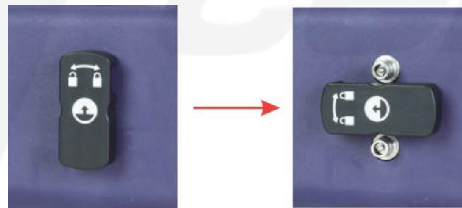

Contact the professionals at Fiber Optic Center for a quote or to get more details.

focenter.com • 508-992-6464 | (800) 473-4237 • sales@focenter.com

23 Centre Street • New Bedford, MA 02740 USA

Depressurization of the CleanBlastPRO begins immediately. Observe the message and count-down timer that appear on the LCD screen and wait for depressurization to complete.

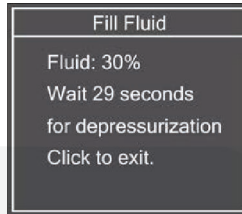

Step 4 Ensure that depressurization is completed.

The following message appears on the LCD screen.

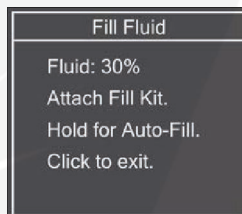

Step 5 Connect the handset connector to the nozzle of the handset.

Step 6 Do the following:

- a. Orient the fill connector on the refill assembly so that the marking TOP is facing up.
- b. Press the top and bottom levers on the fill connector and connect it to the refill port on the CleanBlastPRO.

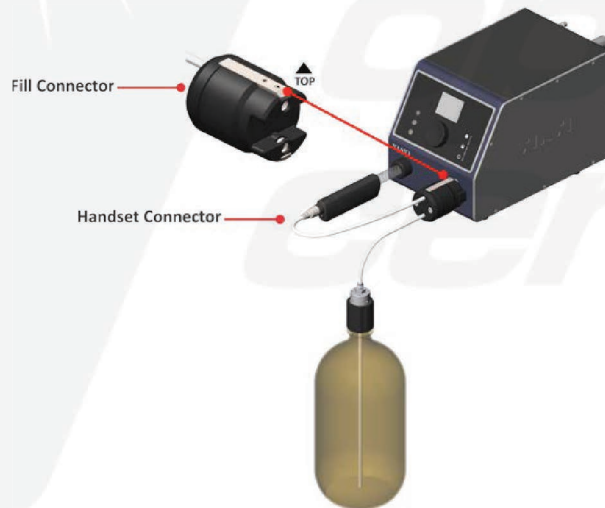

Important: Ensure that the fill connector remains steady while in use. Bumping or jostling the connector during refill can cause solvent to leak from the fittings.

Contact the professionals at Fiber Optic Center for a quote or to get more details.

focenter.com • 508-992-6464 | (800) 473-4237 • sales@focenter.com

23 Centre Street • New Bedford, MA 02740 USA

Getting started
Filling the solvent tank

Step 7 Press and hold the dial until the message **One moment** appears on the LCD screen, and then release the dial.

Note: If you release the dial too soon, the previous menu appears on the LCD screen and auto fill will not start.

Step 8 Observe the fluid gauge and the messages that appear on LCD screen.

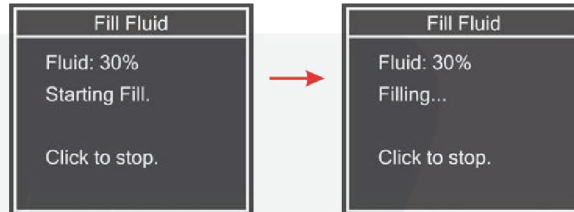

Step 9 Do either of the following:

- Allow the auto fill to continue until the tank is full and auto fill automatically stops. Observe the message that appears on the LCD screen.

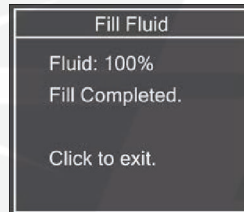

- Click the dial to manually stop the auto fill. Observe the message that appears on the LCD screen.

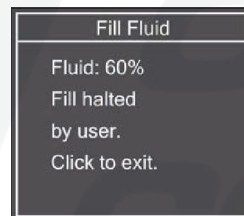

Note: If the solvent runs out before the tank is full, auto fill will automatically stop. Observe the message that appears on the LCD screen.

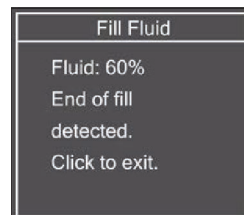

Contact the professionals at Fiber Optic Center for a quote or to get more details.

focenter.com • 508-992-6464 | (800) 473-4237 • sales@focenter.com

23 Centre Street • New Bedford, MA 02740 USA

- Step 10 Click the dial to return to the previous menu, and then disconnect the fill connector from the handset nozzle.
- Step 11 Disconnect the fill connector from the CleanBlastPRO by pressing the top and bottom levers on the connector, and then gently pulling it back.
- Step 12 Rotate the refill port cover clockwise to close it.

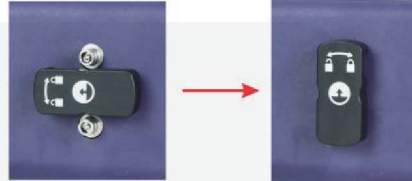

- Step 13 Remove the refill kit assembly from the bottle of solvent, and store it in a contaminant-free zipper locking bag.

Important: If you choose to leave the refill kit assembly installed on the bottle of solvent, ensure that the fill and handset connectors are wrapped and that the assembly and bottle are stored in a contaminate-free manner.

— End —

Configuring custom cleaning profiles

CleanBlastPRO provides factory-configured cleaning profiles optimized for Simplex and MPO fibers. The Simplex and MPO profiles cannot be modified; however, you can configure up to five custom profiles to meet particular cleaning requirements, and then modify them as required. For more information, see “Select Profile and Edit:CUSTOM” on page A-3 and “Custom profile examples” on page C-1.

- Step 1 On the LCD screen, click **Profiles** on the **Main Menu**, and then click **Profiles**.

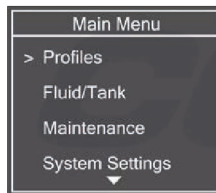

Contact the professionals at Fiber Optic Center for a quote or to get more details.

focenter.com • 508-992-6464 | (800) 473-4237 • sales@focenter.com

23 Centre Street • New Bedford, MA 02740 USA

Getting started
Configuring custom cleaning profiles

Step 2 On the **Select Profile** menu, scroll to a custom profile option (**CUSTOM1** to **CUSTOM5**), and then press and hold the dial to access the **Edit: CUSTOM** menu for the profile.

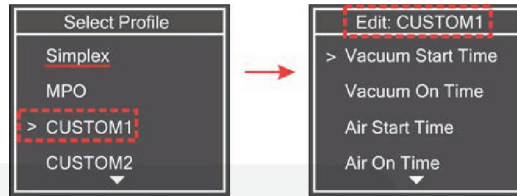

Note: An underline denotes the profile that the CleanBlastPRO is using for cleaning sessions.

Step 3 Do the following:

- On the **Edit: CUSTOM** menu, scroll to and click a parameter.
- On the **Edit** menu for the parameter, rotate the dial to specify a setting, and then click to confirm the setting.

The LCD screen returns to the **Edit: CUSTOM** menu for the custom profile.

Note: You can exit the **Edit** menu for the parameter without changing the setting by pressing and holding the dial or scrolling to and clicking the **Back** icon (see “Menu icons” on page A-2).

Step 4 Repeat Step 3 for each cleaning parameter.

Step 5 After all required parameters are configured, scroll to and click **Save** on the **Edit: CUSTOM** menu.

Important: If you exit the **Edit: CUSTOM** menu without saving the newly specified configuration settings, the settings are discarded.

— End —

Contact the professionals at Fiber Optic Center for a quote or to get more details.

focenter.com • 508-992-6464 | (800) 473-4237 • sales@focenter.com

23 Centre Street • New Bedford, MA 02740 USA

Handset operation

Before you begin cleaning fiber end faces, review the handset configuration settings and, if required, modify any setting. Table 2-1 lists configurable options for operating the handset.

Table 2-1: Handset configuration options

Option	Description	Available settings
Flashlight	Enable flashlight operation	<ul style="list-style-type: none"> • Enable (default) • Disable
Maintenance Indicators	Enable or disable handset alerts of maintenance conditions indicated by LEDs	<ul style="list-style-type: none"> • Buzzer: Enable (default)/Disable • Light: Enable (default)/Disable
Button Configuration	Configure handset button operation	<ul style="list-style-type: none"> • Dual Button (default): Press one button (top or bottom) and then the other button to initiate a cleaning cycle. Press only the top button or only the bottom button to control the flashlight. • Bottom Button: Press only the bottom button to initiate a cleaning cycle. Press only the top button to control the flashlight. • Top Button: Press only the top button to initiate a cleaning cycle. Press only the bottom button to control the flashlight.

Modifying handset settings

Step 1 On the LCD screen, click **System Settings** on the **Main Menu**, and then click **Handset Settings** to access the **Handset Settings** menu.

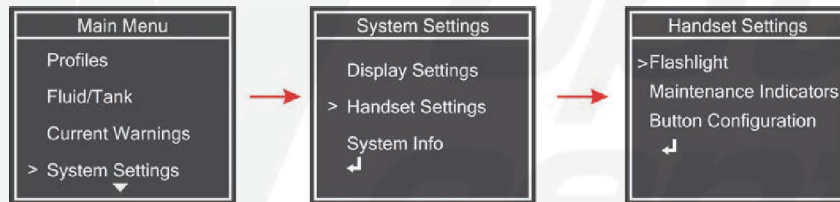

Step 2 Select a handset configuration option to access the menu for that option.

Step 3 Select a setting.

Step 4 Click to return to the previous menu.

— End —

Contact the professionals at Fiber Optic Center for a quote or to get more details.

focenter.com • 508-992-6464 | (800) 473-4237 • sales@focenter.com

23 Centre Street • New Bedford, MA 02740 USA

Getting started
Foot pedal operation

Foot pedal operation

CleanBlastPRO provides an input for operation via an optional foot pedal.

Note: Foot pedal type must be $\frac{1}{4}$ " (6.35 mm) Normally Open (NO); for example, Foot Pedal FCLP-FP-01 (see "Ordering information" on page 1-3) or a Casio® keyboard foot pedal.

- Step 1 Ensure that the foot-pedal connector is within easy reach of the CleanBlastPRO.
- Step 2 Connect the foot pedal to the foot-pedal input at the rear of the device (see Figure 2-2 on page 2-2).
- Step 3 Tap the foot pedal to ensure that the handset fires.

— End —

Connecting an FCLT Series cleaning tip to the handset

Important: Always store unused cleaning tips in a dust-proof container. For information about supported cleaning tips, see "FCLT Series cleaning tips" on page 1-4.

- Step 1 Place the cleaning tip straight onto the threads of handset nozzle.



- Step 2 Thread the collar of the cleaning tip and rotate to secure it to the nozzle.



- Step 3 Prime the handset. See "Priming the handset" on page 3-2.

— End —

Contact the professionals at Fiber Optic Center for a quote or to get more details.

focenter.com • 508-992-6464 | (800) 473-4237 • sales@focenter.com

23 Centre Street • New Bedford, MA 02740 USA

3 Fiber cleaning

- “Before you begin cleaning” on page 3-2
- “Priming the handset” on page 3-2
- “Performing a cleaning cycle” on page 3-3

*fiber
optic
center*

Contact the professionals at Fiber Optic Center for a quote or to get more details.

[focenter.com](https://www.focenter.com) • 508-992-6464 | (800) 473-4237 • sales@focenter.com

23 Centre Street • New Bedford, MA 02740 USA

Data is subject to change without notice. FOC last update 4/23/2026.

Fiber cleaning
Before you begin cleaning

Before you begin cleaning

Ensure the following...	See...
The CleanBlastPRO is located on a level, stable surface and powered on.	"Powering the CleanBlastPRO" on page 2-7
The CleanBlastPRO is connected to an air source.	"Connecting or disconnecting an air source" on page 2-8
The Ready LED is lit.	"Indicators and menu navigation" on page 2-4
There is an adequate amount of solvent in the tank.	"Filling the solvent tank" on page 2-9
A cleaning tip suitable for each connector type to be cleaned is available.	<ul style="list-style-type: none"> "FCLT Series cleaning tips" on page 1-4 "Connecting an FCLT Series cleaning tip to the handset" on page 2-18
Handset operation is configured as required, or, optionally, a foot pedal is connected to the CleanBlastPRO.	<ul style="list-style-type: none"> "Handset operation" on page 2-17 "Foot pedal operation" on page 2-18
The handset is primed.	"Priming the handset" on page 3-2

Priming the handset

Prime the CleanBlastPRO handset to ensure that there is no air in the fluid line and to remove contaminants from the nozzle and cleaning tip. Priming applies a regular cleaning cycle followed by an extended discharge of solvent and then a longer drying and vacuuming cycle.

Important: Priming is important for consistent operation. VIAVI recommends priming before each cleaning session and after changing the cleaning tip.

- Step 1 Prepare an empty glass container for the solvent that will be discharged from the handset. The container must be able to accommodate at least 10 ml of solvent.
- Step 2 Connect the cleaning tip required for the cleaning session to the handset.
- Step 3 If required, review the **Button Configuration** settings (see "Handset operation" on page 2-17).
- Step 4 Position the handset over the container, hold down the handset button/buttons required for operation for at least 10 seconds, or tap and hold the foot pedal if in use.

The priming cycle begins immediately and is completed when the fluid and air streams have stopped. The CleanBlastPRO is then ready to clean fiber end faces.

	<p>CAUTION</p> <p>Never reuse solvent drained from the CleanBlastPRO. Reusing drained solvent can introduce dust and other contaminants from the air into the CleanBlastPRO. Ensure that drained solvent is immediately discarded in accordance with regional regulations for the safe disposal of such fluids.</p>
---	--

— End —

Contact the professionals at Fiber Optic Center for a quote or to get more details.

focenter.com • 508-992-6464 | (800) 473-4237 • sales@focenter.com

23 Centre Street • New Bedford, MA 02740 USA

Performing a cleaning cycle

The CleanBlastPRO can perform either regular or extended cleaning of fiber end faces. In a regular cleaning cycle, the settings defined in the active cleaning profile (e.g., Simplex, MPO, or CUSTOM) ensure that an optimal series of precision air, solvent, and vacuum steps is applied. Therefore, this cycle should provide suitable results for most typical cleaning requirements.

Note: By default, only the factory-set cleaning profiles (Simplex and MPO) have defined settings. Custom cleaning profiles must be configured (see “Configuring custom cleaning profiles” on page 2-15).

Performing a regular cleaning cycle

Step 1 Review “Before you begin cleaning” on page 3-2.

Step 2 On the LCD screen, click **Profiles** on the **Main Menu**, and then scroll to and click a profile on the **Select Profile** menu. An underline indicates the active cleaning profile.



Step 3 Press the handset button/buttons, or tap the foot pedal if in use.

The cleaning cycle begins immediately and is completed when the solvent and air streams have stopped.

— End —

Performing an extended cleaning cycle

An extended cleaning cycle can be used to clean heavily contaminated fiber end faces. This cycle is comprised of a regular cleaning cycle followed by a priming cycle, which applies an extended spray of solvent and then additional vacuuming and drying.

Step 1 Review “Before you begin cleaning” on page 3-2.

Step 2 Hold down the handset button/buttons or the foot pedal (if installed) for at least 10 seconds.

The cleaning cycle begins immediately and is completed when the solvent and air streams have stopped.

Note: It is not uncommon for a small amount of solvent to leak from the fiber connector during an extended cleaning cycle.

— End —

Contact the professionals at Fiber Optic Center for a quote or to get more details.

focenter.com • 508-992-6464 | (800) 473-4237 • sales@focenter.com

23 Centre Street • New Bedford, MA 02740 USA



4 Maintenance

- “Setting up the CleanBlastPRO with a check valve and pressure tank” on page 4-2
- “Replacing air filters” on page 4-3
- “Auto-drain valves” on page 4-6
- “Draining the solvent” on page 4-7
- “Preparing the CleanBlastPRO for transportation/shipping” on page 4-9
- “Accessing system settings and information” on page 4-10
- “Updating the CleanBlastPRO firmware” on page 4-11
- “Exporting the log file” on page 4-13

*fiber
optic
center*

Contact the professionals at Fiber Optic Center for a quote or to get more details.

focenter.com • 508-992-6464 | (800) 473-4237 • sales@focenter.com

23 Centre Street • New Bedford, MA 02740 USA

Maintenance
Setting up the CleanBlastPRO with a check valve and pressure tank

Setting up the CleanBlastPRO with a check valve and pressure tank

For consistent cleaning operation, ensure that the CleanBlastPRO is not starved of air flow when other equipment that shares the air source (for example, a nearby air gun nozzle, other CleanBlastPRO systems) is in use, or when very long, small diameter air supply runs are used.

To isolate the air source in such situations, VIAVI recommends setting up the CleanBlastPRO with an inexpensive local pressure tank (half-gallon or larger) and a check valve exactly as shown in Figure 4-1 and Figure 4-2. See “Connecting or disconnecting an air source” on page 2-8 for more information.

Important: Ensure that the check valve is oriented so that air can enter the pressure tank, but will not exit the tank after the air pressure is removed.

Figure 4-1: CleanBlastPRO, check valve, and pressure tank - front view of setup

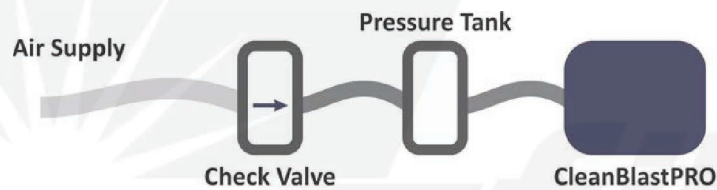
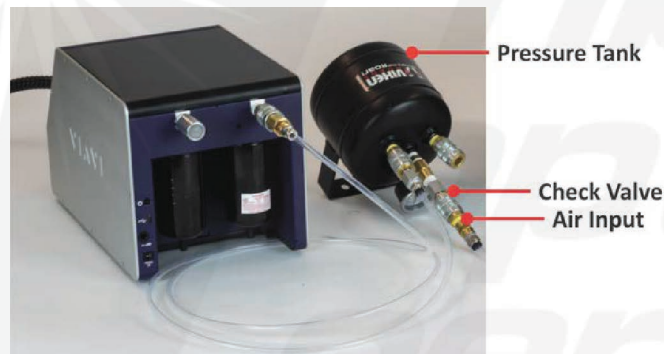
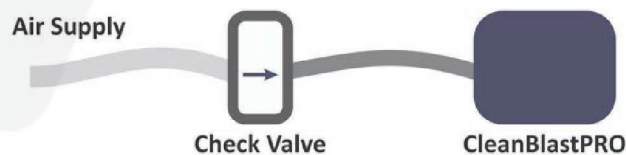

Figure 4-2: CleanBlastPRO, check valve, and pressure tank - rear view of setup



Note: The air filter canisters of the CleanBlastPRO can act as a small volume air tank. Using a check valve before the air input to the CleanBlastPRO exactly as shown in Figure 4-3 can be helpful if the air supply might be briefly (less than one second) impacted or if the supply runs are poor.

Figure 4-3: CleanBlastPRO and check valve



Contact the professionals at Fiber Optic Center for a quote or to get more details.

focenter.com • 508-992-6464 | (800) 473-4237 • sales@focenter.com

23 Centre Street • New Bedford, MA 02740 USA

Replacing air filters

The CleanBlastPRO features replaceable air filters to ensure that contaminants do not enter the system during either use of the device or refilling of the solvent take:

- Fine air filter (FCLP-FA-F3) and coarse air filter (FCLP-FA-F2) contained in canisters located at the rear of the device. VIAVI recommends replacing these air filters every 12 months.
- Air filter (FCLP-FA-F1) contained in the cap connector of the CleanBlastPRO Auto Refill Kit. VIAVI recommends replacing this air filter every 12 months.

Replacing the fine and coarse air filters

Important: The fine and coarse air filters are housed in separate canisters. Ensure that you install the correct replacement filter in each location shown in [Figure 4-4](#), which also shows the housing components of the filters.

Figure 4-4: CleanBlastPRO fine air and coarse air filters

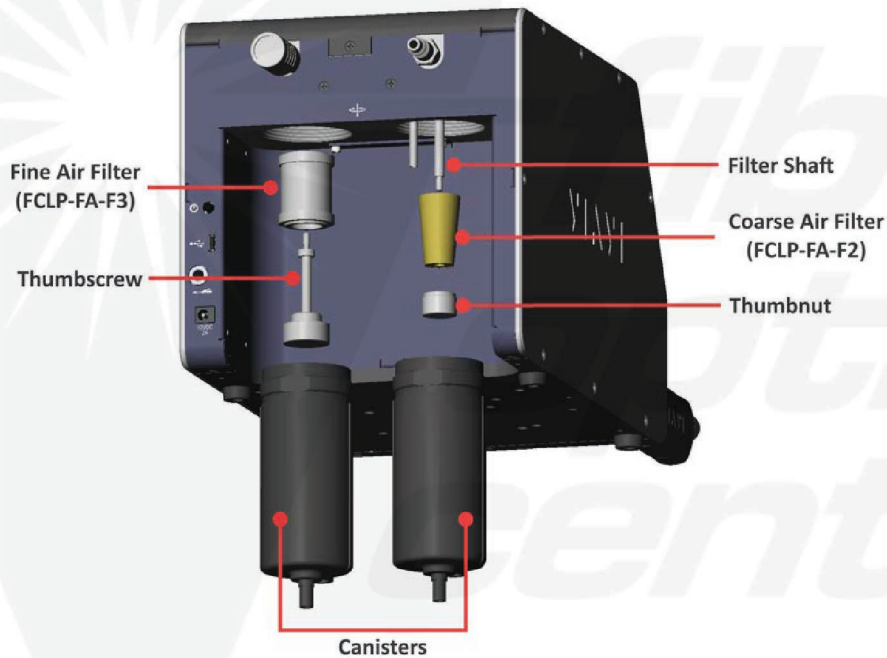

CAUTION

Power off the CleanBlastPRO, and disconnect the air source and all cables connected to the device before replacing the air filters. See [“Powering off”](#) on page 2-7 and [“Disconnecting the air source”](#) on page 2-8.

Contact the professionals at Fiber Optic Center for a quote or to get more details.

focenter.com • 508-992-6464 | (800) 473-4237 • sales@focenter.com

23 Centre Street • New Bedford, MA 02740 USA

Maintenance
Replacing air filters

- Step 1 Position the CleanBlastPRO so that the overhang at the rear of the device extends past the edge of the work surface and all four pads on the bottom of the device are fully on the work surface.
- Step 2 Rotate the canister counterclockwise until it is fully loosened, and then carefully pull it straight down to expose the air filter.

Important: Do not attempt to pull the canister away from the device before the air filter is fully exposed and the top of the canister can clear the bottom of the air filter.

- Step 3 Remove the air filter:
- To remove the fine air filter, rotate the thumbscrew counterclockwise until it detaches from the device, and then remove the filter from the thumbscrew.
 - To remove the coarse air filter, rotate the thumbnut counterclockwise until it detaches from the shaft it is connected to, and then remove the filter from the shaft.

Note: Do not misplace the o-ring that is housed within the top of the thumbnut.

- Step 4 Discard the air filter.
- Step 5 Ensure that you have the correct replacement for the filter you have removed, and then install it:
- To install the replacement fine air filter, slip the filter onto the thumbscrew, position the filter into its socket on the device, and then secure it with the thumbscrew. Do not overtighten the thumbscrew.
 - To install the replacement coarse air filter, slip the filter onto the shaft, and then secure it with the thumbnut. Do not overtighten the thumbnut.
- Step 6 Reinstall the canister, rotating it clockwise to secure it. Do not overtighten the canister.
- Step 7 Do the following to reset the filter age:
- a. Power on the device (see “Powering the CleanBlastPRO” on page 2-7).
 - b. On the LCD screen, click **System Settings** on the **Main Menu**, and then click **System Info**.



- c. On the **System Info** menu, scroll to **Filter Age**, and then hold down the dial to reset the value to 0.

— End —

Contact the professionals at Fiber Optic Center for a quote or to get more details.

focenter.com • 508-992-6464 | (800) 473-4237 • sales@focenter.com

23 Centre Street • New Bedford, MA 02740 USA

Replacing the air filter on the CleanBlastPRO Auto Refill Kit

- Step 1 Ensure that you have the correct replacement air filter (FCLP-FA-F1) on hand.
- Step 2 Using a 1.5-mm hex screwdriver, remove the four (4) screws that secure the stopper to the cap, and then slide the stopper off the tube. Place the stopper and screws in a dust-free container.

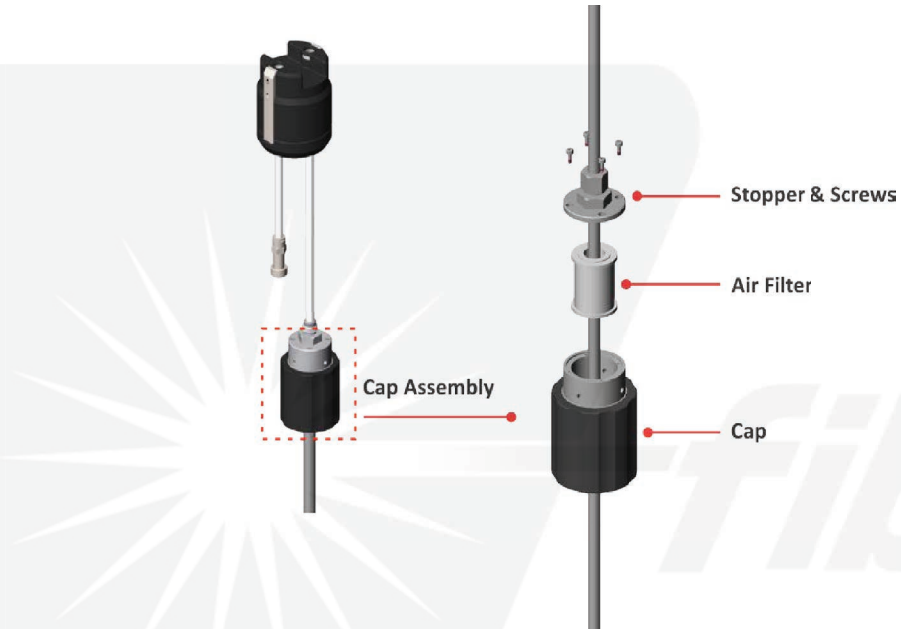

- Step 3 Slide the used air filter off the tube, and insert the replacement filter.
- Step 4 Insert the stopper, and then secure it with the screws. Do not overtighten the screws.

— End —

Contact the professionals at Fiber Optic Center for a quote or to get more details.

focenter.com • 508-992-6464 | (800) 473-4237 • sales@focenter.com

23 Centre Street • New Bedford, MA 02740 USA

Maintenance
Auto-drain valves

Auto-drain valves

Compressed air causes moisture in the air to precipitate out into water. It is very common in high humidity environments for a large amount of water to accumulate inside the air filter canisters. To prevent water from entering into the CleanBlastPRO, each filter canister is equipped with an auto-drain valve so that the water will automatically drain out.

VIAVI recommends connecting a flexible hose (inner diameter approximately 8 mm) to the tube on each auto-drain valve and running the hose to a waste bin into which the water can drain.

Figure 4-5: Auto-drain valves



Contact the professionals at Fiber Optic Center for a quote or to get more details.

focenter.com • 508-992-6464 | (800) 473-4237 • sales@focenter.com

23 Centre Street • New Bedford, MA 02740 USA

Draining the solvent



CAUTION

Never reuse solvent drained from the CleanBlastPRO. Reusing drained solvent can introduce dust and other contaminants from the air into the CleanBlastPRO. Ensure that drained solvent is immediately discarded in accordance with regional regulations for the safe disposal of such fluids.

Notes:

- Perform this procedure only under guidance from VIAVI.
- Draining the solvent can take up to two (2) hours, depending on the amount of solvent present in the tank.
- Ensure that the container into which the solvent will be drained can hold the full amount of solvent (up to 1 liter if tank is full) and that its opening can easily accommodate the flow from the CleanBlastPRO handset.

Step 1 If present, remove the cleaning tip from the handset nozzle and place it in a dust-free container.

Step 2 Install the handset onto a mount holder. See “[Handset features and mounting](#)” on page 2-5.



Step 3 Prepare an empty 2 L glass container into which the solvent can drain.

Step 4 Tilt the handset so that the nozzle is pointed into the container.

Step 5 On the LCD screen, click **Fluid/Tank** on the **Main Menu**, and then click **Drain Fluid** to access the **Drain Fluid** menu.

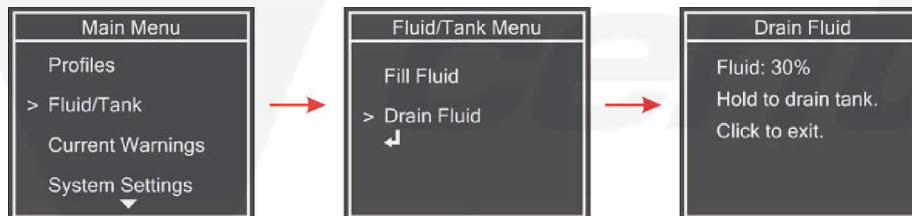

Contact the professionals at Fiber Optic Center for a quote or to get more details.

focenter.com • 508-992-6464 | (800) 473-4237 • sales@focenter.com

23 Centre Street • New Bedford, MA 02740 USA

Maintenance
Draining the solvent

- Step 6 Press and hold the dial until the fluid begins to drain from the handset into the container, and then release the dial. Observe the message that appears on the LCD screen.

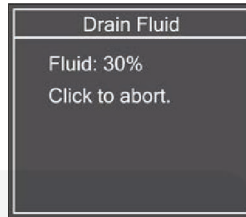

Note: If you release the dial too soon, the previous menu appears on the LCD screen and draining will not start.

- Step 7 Observe the front panel as the tank empties:
The fluid percentage updates on the LCD screen and the LEDs of the fluid gauge light relative to the decreasing fluid level.

- Step 8 Do either of the following:
- Allow draining to continue until the tank is empty. Observe the message that appears on the LCD screen.

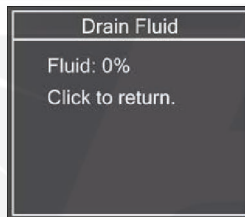

Note: You can leave the CleanBlastPRO unattended as it drains.

- Click the dial to abort the draining process before the tank is emptied. Observe the message that appears on the LCD screen.

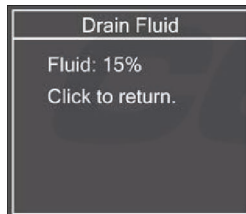

- Step 9 Click the dial to return to the previous menu.

— End —

Contact the professionals at Fiber Optic Center for a quote or to get more details.

focenter.com • 508-992-6464 | (800) 473-4237 • sales@focenter.com

23 Centre Street • New Bedford, MA 02740 USA

Data is subject to change without notice. FOC last update 4/23/2026.

Preparing the CleanBlastPRO for transportation/shipping

Whenever possible, transport/ship the CleanBlastPRO in its original packaging. Always ensure that the device is securely wrapped and fitted inside the container to prevent damage to any part of the device.

Before packing the CleanBlastPRO, do the following to prevent fluid from leaking from the device during transport:

- Step 1 Power off the CleanBlastPRO, and disconnect it from the air source.
- Step 2 Rotate the refill port cover counterclockwise, and allow the device to vent for at least one (1) minute.
- Step 3 Return the refill port cover to the closed position.
- Step 4 Secure the cover with a zip tie.

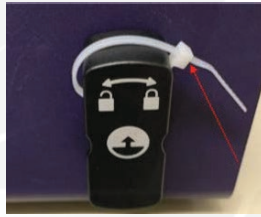

— End —

*Fiber
Optic
Center*

Contact the professionals at Fiber Optic Center for a quote or to get more details.

focenter.com • 508-992-6464 | (800) 473-4237 • sales@focenter.com

23 Centre Street • New Bedford, MA 02740 USA

Maintenance
Accessing system settings and information

Accessing system settings and information

See “System Settings” on page A-5 for information about options available on the **System Settings** menu.

Step 1 On the LCD screen, click **System Settings** on the **Main Menu**.



Step 2 On the System Settings menu, click any of the following options:

- **Display Settings** to view or modify display settings for the LCD screen.
- **Handset Settings** to view or modify handset configuration settings.
- **System Info** to view CleanBlastPRO system information, such as serial number and firmware version, and access system-task menus, such as **Firmware Update**.

— End —

Contact the professionals at Fiber Optic Center for a quote or to get more details.

focenter.com • 508-992-6464 | (800) 473-4237 • sales@focenter.com

23 Centre Street • New Bedford, MA 02740 USA

Updating the CleanBlastPRO firmware

Use the CleanBlastPRO™ Firmware USB Flash Drive Creator to generate and save the firmware file to a USB-C flash drive. After the file is generated, connect the flash drive to the CleanBlastPRO and update the firmware.

Important: Use only a FAT-32 formatted USB-C flash drive.

Generating the firmware file

- Step 1 Connect a FAT-32 formatted USB-C flash drive to your computer.
- Step 2 In a web browser, go to <http://cbpro.updatemyunit.net>.
- Step 3 Download the executable file for the CleanBlastPRO Firmware USB Flash Drive Creator (CBProFirmware_X.X.X.X.exe).
- Step 4 Navigate to the folder where the executable file is located, and then double-click the file to start the CleanBlastPRO Firmware USB Flash Drive Creator.

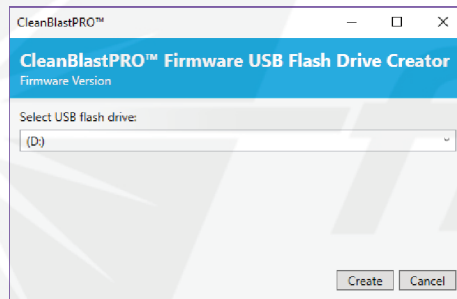

Note: If a USB flash drive is not already connected to the computer, you will be prompted to connect one.

- Step 5 Select the flash drive you want to use, and then click **Create**.

The CleanBlastPRO Firmware USB Flash Drive Creator automatically creates the folder VIAVI on the flash drive and saves the firmware file CBPRO.BIN to that folder.

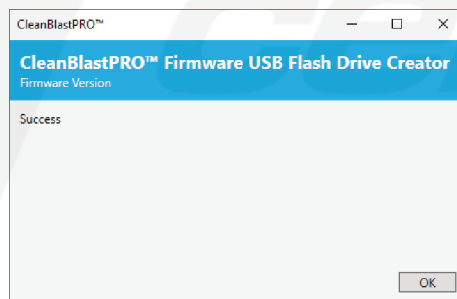

- Step 6 Confirm the availability of the firmware file by navigating to and opening the VIAVI folder on the flash drive.

— End —

Contact the professionals at Fiber Optic Center for a quote or to get more details.

focenter.com • 508-992-6464 | (800) 473-4237 • sales@focenter.com

23 Centre Street • New Bedford, MA 02740 USA

Data is subject to change without notice. FOC last update 4/23/2026.

Maintenance
Updating the CleanBlastPRO firmware

Updating the firmware

- Step 1 Connect the flash drive where the firmware file is saved to the USB-C port at the rear of the CleanBlastPRO (see [Figure 2-2 on page 2-2](#)).
- Step 2 On the LCD screen, click **System Settings** on the **Main Menu**, click **System Info**, and then click **Firmware Update**.

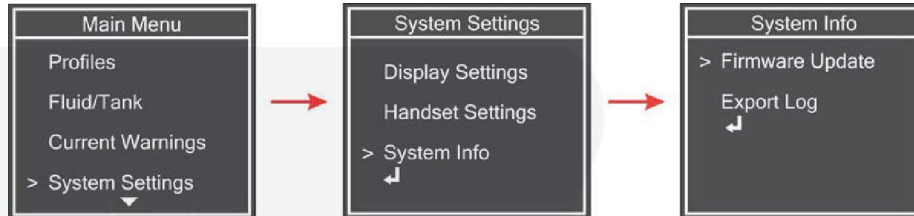

- Step 3 On the **Firmware Update** menu, click **Confirm** to start the update.



The firmware update takes several minutes to complete. While the update is in progress, the Busy LED on the CleanBlastPRO lights yellow. When the update is completed, the CleanBlastPRO automatically restarts (powers off and then powers on).

Do not remove the USB stick from the port while the firmware update is in progress and the Busy LED is on. Remove the USB stick only after the CleanBlastPRO has fully restarted and the **VIAVI** menu appears on the LCD screen.

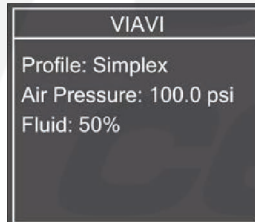

Important: If the firmware update is not successful, the CleanBlastPRO will not automatically restart. Ensure that the flash drive is fully seated in the USB-C port at the rear the CleanBlastPRO, and then perform [Step 2](#) and [Step 3](#) again.

— End —

Contact the professionals at Fiber Optic Center for a quote or to get more details.

focenter.com • 508-992-6464 | (800) 473-4237 • sales@focenter.com

23 Centre Street • New Bedford, MA 02740 USA

Exporting the log file

- Use only a FAT-32 formatted USB-C flash drive.

Step 1 Connect a FAT-32 formatted USB-C flash drive to the USB-C port at the rear of the CleanBlastPRO (see [Figure 2-2 on page 2-2](#)).

Step 2 On the LCD screen, click **System Settings** on the **Main Menu**, click **System Info**, and then click **Export Log**.

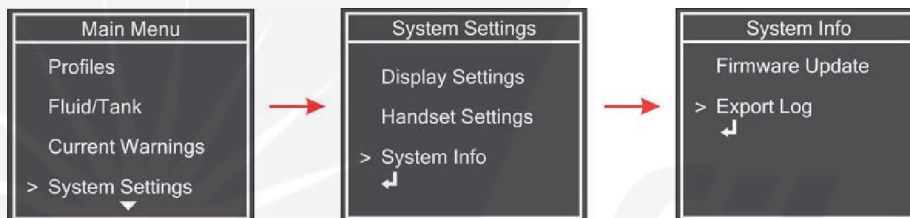

Step 3 On the **Export Log** menu, click **Confirm** to start the export operation.



The export operation takes several minutes to complete. While the operation is in progress, the Busy LED on the CleanBlastPRO lights yellow. When the operation is completed, the Busy LED turns off and the Ready LED lights green.

Important: Do not remove the USB flash drive from the port while the Busy LED is on. Remove it only after the operation is completed and the Ready LED is on.

— End —

Contact the professionals at Fiber Optic Center for a quote or to get more details.

focenter.com • 508-992-6464 | (800) 473-4237 • sales@focenter.com

23 Centre Street • New Bedford, MA 02740 USA



Appendix A CleanBlastPRO menu summary

This section covers the following information:

- “Menu icons” on page A-2
- “VIAVI Menu” on page A-2
- “Main Menu” on page A-3
- “Select Profile and Edit:CUSTOM” on page A-3
- “Fluid/Tank Menu” on page A-4
- “Current Warnings” on page A-4
- “System Settings” on page A-5

*fiber
optic
center*

Contact the professionals at Fiber Optic Center for a quote or to get more details.

focenter.com • 508-992-6464 | (800) 473-4237 • sales@focenter.com

23 Centre Street • New Bedford, MA 02740 USA

Data is subject to change without notice. FOC last update 4/23/2026.

Appendix A
CleanBlastPRO menu summary

Menu icons



Icon	Action
>	Scroll/Select
▼	Continue
←	Back

VIAVI Menu

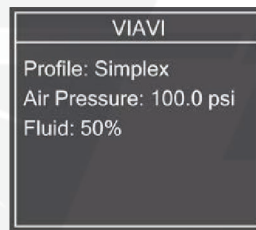

Option	Use
Profile	Active cleaning profile
Air Pressure	Available air pressure
Fluid	Level of solvent in tank

Contact the professionals at Fiber Optic Center for a quote or to get more details.

focenter.com • 508-992-6464 | (800) 473-4237 • sales@focenter.com

23 Centre Street • New Bedford, MA 02740 USA

Data is subject to change without notice. FOC last update 4/23/2026.

Main Menu

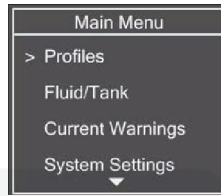

Option	Use
Profiles	See “Select Profile and Edit:CUSTOM” on page A-3.
Fluid/Tank	See “Fluid/Tank Menu” on page A-4.
Current Warnings	See “Current Warnings” on page A-4.
System Settings	See “System Settings” on page A-5.

Select Profile and Edit:CUSTOM

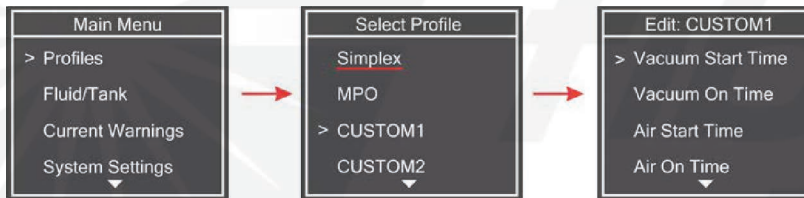

Option	Use
Simplex	Apply cleaning parameters suitable for Simplex fiber end faces
MPO	Apply cleaning parameters suitable for MPO fiber end faces
CUSTOM1	User-defined settings for the following cleaning parameters: <ul style="list-style-type: none"> • Vacuum Start Time • Vacuum On Time¹ • Air Start Time • Air On Time^{1,2} • Fluid Start Time • Fluid On Time^{1,2} • Num Cycles³ • Lockout Time⁴ See “Configuring custom cleaning profiles” on page 2-15 and “Custom profile examples” on page C-1.
CUSTOM2	
CUSTOM3	
CUSTOM4	
CUSTOM5	

1. VIAVI recommends setting this cleaning parameter to 100 ms or higher.
2. To ensure that the fluid atomizes correctly, the air must be on when the fluid is on.
3. Specifies the number of times the cleaning parameters for a regular cleaning cycle are repeated.
4. Specifies the amount of time in seconds that handset/foot pedal operation is disabled after a cleaning cycle is performed.

Contact the professionals at Fiber Optic Center for a quote or to get more details.

focenter.com • 508-992-6464 | (800) 473-4237 • sales@focenter.com

23 Centre Street • New Bedford, MA 02740 USA

Appendix A
CleanBlastPRO menu summary

Fluid/Tank Menu

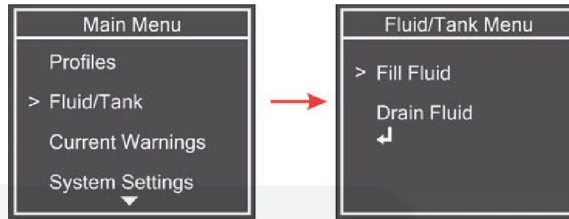

Option	Use
Fill	Perform Manual fill or Auto Fill operations. See “Filling the solvent tank” on page 2-9.
Drain Fluid	Perform Drain Fluid operation. See “Draining the solvent” on page 4-7.

Current Warnings

A warning message displays while the corresponding condition is present on the CleanBlastPRO.

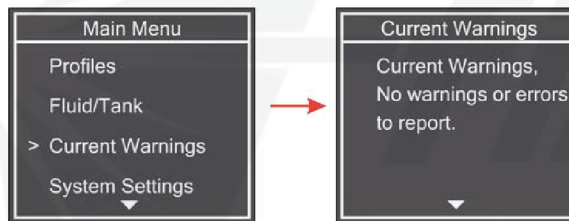

Message	See...
Current Warnings. No warnings or errors to report.	—
Error. Pressure sensor readings are out of normal range.	“Specifications” on page B-1.
Error. Tilt detected. Keep device level.	“Work station requirements” on page 2-6.
Error. Device solvent tank is empty.	“Filling the solvent tank” on page 2-9.
Error. Please prime the unit before firing.	“Priming the handset” on page 3-2.
Error. Foot pedal detected as Normally Closed type. Use Normally Open type only.	“Foot pedal operation” on page 2-18.
Warning. Input pressure is lower than normal.	“Specifications” on page B-1.

Contact the professionals at Fiber Optic Center for a quote or to get more details.

focenter.com • 508-992-6464 | (800) 473-4237 • sales@focenter.com

23 Centre Street • New Bedford, MA 02740 USA

System Settings



Option	Use
Display Settings	Configure settings for the following display parameters: <ul style="list-style-type: none"> • LCD Backlight • LCD Sleep Timer • LED Brightness
Handset Settings	Configure the following parameters for handset operation. See “ Handset operation ” on page 2-17. <ul style="list-style-type: none"> • Flashlight • Maintenance Indicators • Button Configuration
System Info	View the following device/system information or perform related operation: <ul style="list-style-type: none"> • SN [Serial number] • Firmware version • Filter Age. See “Replacing air filters” on page 4-3. • Firmware Update. See “Setting up the CleanBlastPRO with a check valve and pressure tank” on page 4-2. • Export Log. See “Exporting the log file” on page 4-13.

Contact the professionals at Fiber Optic Center for a quote or to get more details.

focenter.com • 508-992-6464 | (800) 473-4237 • sales@focenter.com

23 Centre Street • New Bedford, MA 02740 USA



Appendix B Specifications

Table B-1: CleanBlastPRO Benchtop Fiber End Face Cleaning System specifications

Parameter	Specification
Air/Gas Source	Clean, dry air ¹ or nitrogen (N ₂)
Air/Gas Pressure	80 to 140 psi, 100 psi nominal ^{2,3}
Air/Gas Inlet	1/4" Industrial Quick-Disconnect Coupling ⁴
Internal Solvent Tank Capacity	1 L
Input Power	12V DC, 2A power supply (included) ⁵
Power Consumption (Average)	< 12 W
Operating temperature	15 to 30 °C (59 to 86 °F)
Storage temperature	0 to 40 °C (32 to 104 °F)
Dimensions	See Figure B-1.

1. As per ISO8573 Class 5 - Clean Dry Air. (Oil less than 25mg/m³).
2. CleanBlastPRO will continue to operate when pressure is between 50 to 80 psi; however, cleaning might be impaired.
3. Pressure relief safety mechanism activates when pressure exceeds 150 psi and resets when air-source connection is removed.
4. Fitting can be replaced with any 1/4" NPT Male fitting.
5. Use only the power adapter shipped with the CleanBlastPRO to power the device.

Figure B-1: CleanBlastPRO dimensions (shown in millimeters)

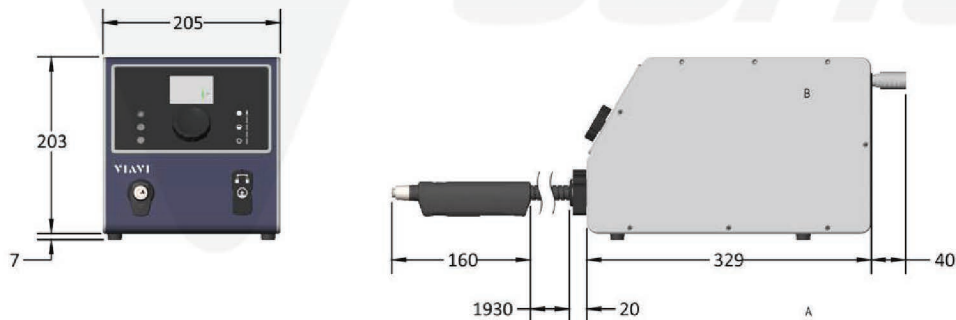

Contact the professionals at Fiber Optic Center for a quote or to get more details.

focenter.com • 508-992-6464 | (800) 473-4237 • sales@focenter.com

23 Centre Street • New Bedford, MA 02740 USA



Appendix C Custom profile examples

This section covers the following information:

- “Example 1 - Basic Clean” on page C-2
- “Example 2: Basic Clean - Two Cycles” on page C-3
- “Example 3: Blow/Vac Then Clean” on page C-4

*fiber
optic
center*

Contact the professionals at Fiber Optic Center for a quote or to get more details.

focenter.com • 508-992-6464 | (800) 473-4237 • sales@focenter.com

23 Centre Street • New Bedford, MA 02740 USA

Data is subject to change without notice. FOC last update 4/23/2026.

Example 1 - Basic Clean

Profile description

- Start fluid, air, and vacuum time = 0
- Fluid on for 200 msec (0.2 sec)
- Air and vacuum on for 2000 msec (2 sec)

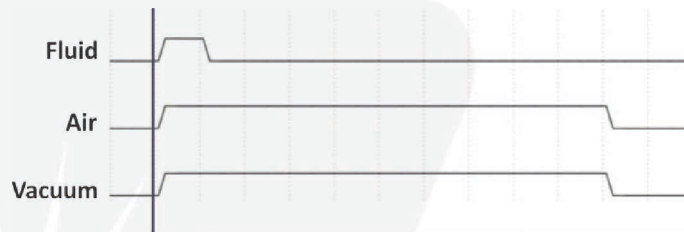

Configuration

Parameter	User-defined Value
Vacuum Start Time	0
Vacuum On Time	2000
Air Start Time	0
Air On Time	2000
Fluid Start Time	0
Fluid On Time	200
Num Cycles	1
Lockout Time	—

*fiber
optic
center*

Contact the professionals at Fiber Optic Center for a quote or to get more details.

focenter.com • 508-992-6464 | (800) 473-4237 • sales@focenter.com

23 Centre Street • New Bedford, MA 02740 USA

Data is subject to change without notice. FOC last update 4/23/2026.

Example 2: Basic Clean - Two Cycles

Profile description

- Apply two cycles of the Basic Clean profile with one button press

Note: A 400 msec (approximately) dwell time with all valves off is automatically added between cycles. This dwell time can be increased by increasing the start times for each value.

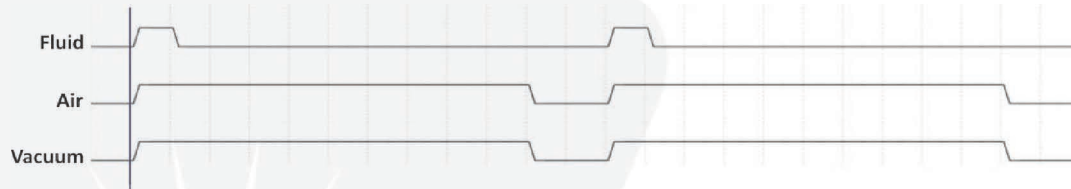

Configuration

Parameter	User-defined Value
Vacuum Start Time	0
Vacuum On Time	2000
Air Start Time	0
Air On Time	2000
Fluid Start Time	0
Fluid On Time	200
Num Cycles	2
Lockout Time	—

*fiber
optic
center*

Contact the professionals at Fiber Optic Center for a quote or to get more details.

focenter.com • 508-992-6464 | (800) 473-4237 • sales@focenter.com

23 Centre Street • New Bedford, MA 02740 USA

Data is subject to change without notice. FOC last update 4/23/2026.

Example 3: Blow/Vac Then Clean

Profile description

- First blow air, then vacuum, then clean, then dry.
- Blow air and pull vacuum (delay vacuum start 200 msec) for 600 msec, then basic clean cycle with 200 msec of fluid, air, and vacuum for 2 sec after fluid starts.

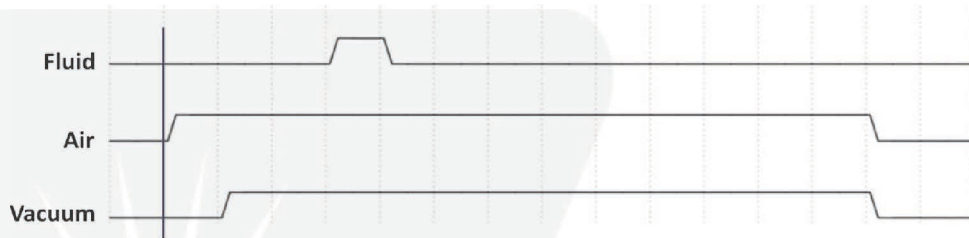

Configuration

Parameter	User-defined Value
Vacuum Start Time	200
Vacuum On Time	2400
Air Start Time	0
Air On Time	2600
Fluid Start Time	600
Fluid On Time	200
Num Cycles	1
Lockout Time	—

*fiber
optic
center*

Contact the professionals at Fiber Optic Center for a quote or to get more details.

focenter.com • 508-992-6464 | (800) 473-4237 • sales@focenter.com

23 Centre Street • New Bedford, MA 02740 USA