

QUICK START GUIDE

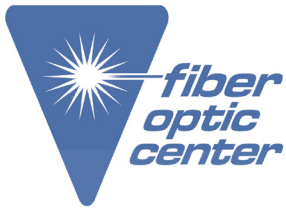

Manufacturer:

Dymax

Product Name:

Dymax BlueWave® MX-150 LED Spot-Curing Emitter - 365nm

Manufacturer Part Number:

42336

▶ [Click here for more details on the Dymax BlueWave® MX-150 LED Spot-Curing Emitter - 365nm](#)

Click the thumbnail below to navigate to the Quick Start Guide

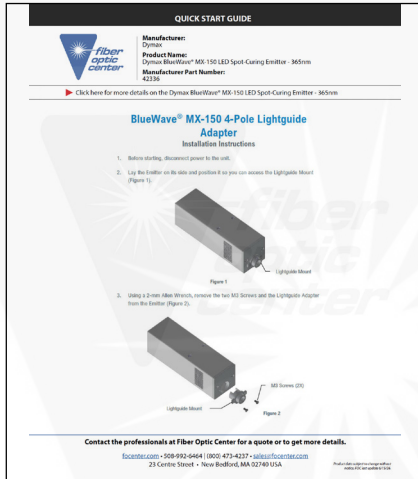

[Bluewave® MX-150 4-Pole Lightguide Adapter Installation Instructions](#)



[Bluewave® MX-150 Lightguide Simulator Installation Instructions](#)

Contact the professionals at Fiber Optic Center for a quote or to get more details.

focenter.com • 508-992-6464 | (800) 473-4237 • sales@focenter.com

23 Centre Street • New Bedford, MA 02740 USA

Product data subject to change without notice. FOC last update 6/18/26.

QUICK START GUIDE

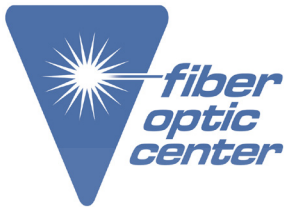

Manufacturer:

Dymax

Product Name:

Dymax BlueWave® MX-150 LED Spot-Curing Emitter - 365nm

Manufacturer Part Number:

42336

▶ [Click here for more details on the Dymax BlueWave® MX-150 LED Spot-Curing Emitter - 365nm](#)

BlueWave® MX-150 4-Pole Lightguide Adapter

Installation Instructions

1. Before starting, disconnect power to the unit.
2. Lay the Emitter on its side and position it so you can access the Lightguide Mount (Figure 1).



Figure 1

3. Using a 2-mm Allen Wrench, remove the two M3 Screws and the Lightguide Adapter from the Emitter (Figure 2).

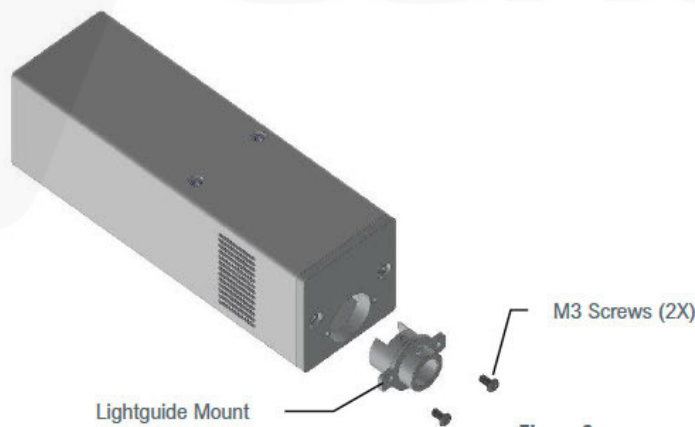

Figure 2

[>> Return to Page 1](#)

Contact the professionals at Fiber Optic Center for a quote or to get more details.

focenter.com • 508-992-6464 | (800) 473-4237 • sales@focenter.com

23 Centre Street • New Bedford, MA 02740 USA

Product data subject to change without notice. FOC last update 6/18/26.

- Using the M3 Screws removed in Step 3, attach the 4-Pole Lightguide Adapter to the Emitter.

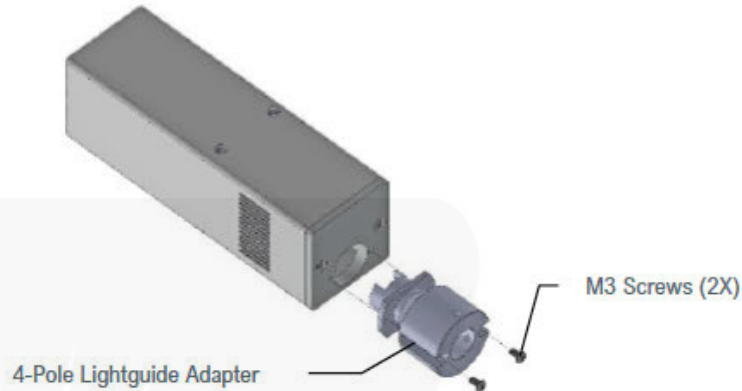

Figure 3

- The unit can now be used with a 4-Pole Lightguide.

NOTE: Once a Lightguide is inserted, a 2-mm Allen Wrench can be used to tighten the Set Screw (Figure 4) to secure the Lightguide in place. **Do not overtighten the Set Screw as overtightening can cause damage.**

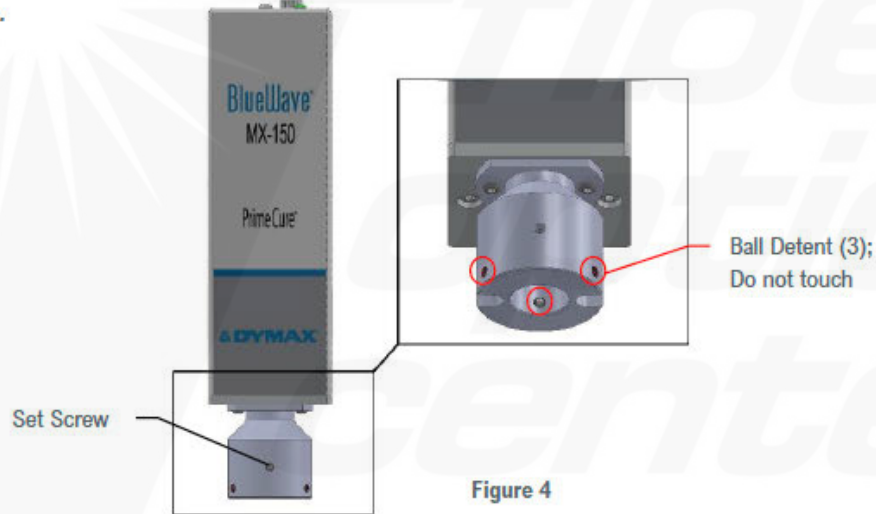

Figure 4

© 2021 Dymax Corporation. All rights reserved. All trademarks in this guide, except where noted, are the property of, or used under license by Dymax Corporation, U.S.A.

The data contained in this bulletin is of a general nature and is based on laboratory test conditions. Dymax does not warrant the data contained in this bulletin. Any warranty applicable to the product, its application and use is strictly limited to that contained in Dymax's standard Conditions of Sale. Dymax does not assume responsibility for test or performance results obtained by users. It is the user's responsibility to determine the suitability for the product application and purposes and the suitability for use in the user's intended manufacturing apparatus and methods. The user should adopt such precautions and use guidelines as may be reasonably advisable or necessary for the protection of property and persons. Nothing in this bulletin shall act as a representation that the product use or application will not infringe a patent owned by someone other than Dymax or act as a grant of license under any Dymax Corporation Patent. Dymax recommends that each user adequately test its proposed use and application before actual repetitive use, using the data contained in this bulletin as a general guide. Q5062 08/25/2021

>> Return to Page 1

Contact the professionals at Fiber Optic Center for a quote or to get more details.

focenter.com • 508-992-6464 | (800) 473-4237 • sales@focenter.com

23 Centre Street • New Bedford, MA 02740 USA

Product data subject to change without notice. FOC last update 6/18/26.

QUICK START GUIDE

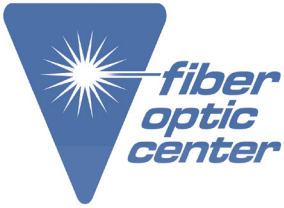

Manufacturer:

Dymax

Product Name:

Dymax BlueWave® MX-150 LED Spot-Curing Emitter - 365nm

Manufacturer Part Number:

42336

▶ [Click here for more details on the Dymax BlueWave® MX-150 LED Spot-Curing Emitter - 365nm](#)

BlueWave® MX-150 Lightguide Simulator

Quick Start Installation Instructions

NOTE: This quick start guide can be used to install a lightguide simulator into any BlueWave® MX-150 emitter (part number 42336, 42337, or 42338).

1. Before starting, verify that the power to the unit is off and the interconnect cable is disconnected.
2. Lay the emitter on its side and position it so you can access the lightguide mount (Figure 1).

Figure 1.

BlueWave® MX-150 Emitter (Lightguide Simulator Not Installed)



3. Using the 1.5-mm allen wrench, rotate the M3 set screw out one turn counterclockwise, just enough so that the lightguide simulator can be fully seated.
4. Before you insert the lightguide simulator into the lightguide mount, verify that the lightguide simulator is clean. If not, clean both ends of the lightguide simulator with isopropyl alcohol and a lint-free cloth.

[>> Return to Page 1](#)

Contact the professionals at Fiber Optic Center for a quote or to get more details.

focenter.com • 508-992-6464 | (800) 473-4237 • sales@focenter.com

23 Centre Street • New Bedford, MA 02740 USA

Product data subject to change without notice. FOC last update 6/18/26.

Figure 2.
Inserting Lightguide Simulator into MX-150

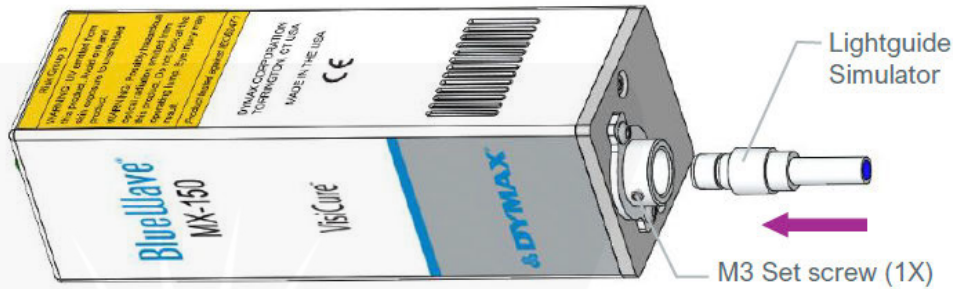

6. Using the 1.5-mm allen wrench, firmly hand tighten the M3 set screw.

NOTE: Do not attempt to overtighten the M3 set screw as damage to the light guide simulator or lightguide mount could occur.

The completed lightguide simulator installation should look like Figure 3.

Figure 3.
BlueWave® MX-150 Emitter (Lightguide Simulator Installed)



© 2021 Dymax Corporation. All rights reserved. All trademarks in this guide, except where noted, are the property of, or used under license by Dymax Corporation, U.S.A.

Please note that most dispensing and curing system applications are unique. Dymax does not warrant the fitness of the product for the intended application. Any warranty applicable to the product, its application and use is strictly limited to that contained in Dymax's standard Conditions of Sale. Dymax recommends that any intended application be evaluated and tested by the user to ensure that desired performance criteria are satisfied.

>> Return to Page 1

Contact the professionals at Fiber Optic Center for a quote or to get more details.

focenter.com • 508-992-6464 | (800) 473-4237 • sales@focenter.com

23 Centre Street • New Bedford, MA 02740 USA

Product data subject to change without notice. FOC last update 6/18/26.