



**Manufacturer:**  
AFL

**Product Name:**  
AFL FOCIS Lightning2 Single Fiber FFLX Coupler

**Manufacturer Part Number:**  
FLTNG2-01-SFC



▶ [Click here for more details on the AFL FOCIS Lightning2 Single Fiber FFLX Coupler](#)

## FOCIS Lightning<sup>®</sup> 2

Fiber Optic Connector Inspection System

User's Guide



Overview



Inspecting MPO Connector



Sharing Results



Settings

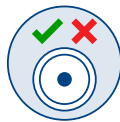

Understanding Results



Generating Reports



BT Pairing



Managing Results

**Contact the professionals at Fiber Optic Center for a quote or to get more details.**

[focenter.com](http://focenter.com) • 508-992-6464 | (800) 473-4237 • [sales@focenter.com](mailto:sales@focenter.com)

23 Centre Street • New Bedford, MA 02740 USA



**Manufacturer:**  
AFL

**Product Name:**  
AFL FOCIS Lightning2 Single Fiber FFLX Coupler

**Manufacturer Part Number:**  
FLTNG2-01-SFC



▶ [Click here for more details on the AFL FOCIS Lightning2 Single Fiber FFLX Coupler](#)

**Table of Contents**

<b>Safety &amp; Compliance</b> .....	<b>4</b>	<b>Settings</b> .....	<b>21</b>
Safety Information .....	4	Main Menu.....	21
Standards Compliance Information .....	4	Settings Menu .....	22
<b>General Information</b> .....	<b>6</b>	Capture Settings.....	22
Product Overview.....	6	To Enable Auto Focus. . . . .	22
Warranty Terms and Conditions.....	6	To Configure Auto-Send. . . . .	22
Repair Services.....	6	To Configure Auto-Save. . . . .	22
Hardware Overview .....	7	To Configure Key Position . . . . .	22
How to View Device Information Menu.....	7	To Configure 'Save to' Destination . . . . .	22
Controls, Display, Interfaces .....	8	Pass/Fail Settings.....	23
Powering Up/Down .....	9	IEC Pass/Fail Analysis. . . . .	23
Battery Charging and Operation .....	10	Example IEC Rule. . . . .	24
Properly Installing and Removing Adapter Tips.....	10	To Configure Pass/Fail Criteria . . . . .	25
Available Inspection Adapter Tips .....	11	Connector Settings.....	26
<b>Live Image Mode - Inspecting MPO Connector</b> .....	<b>12</b>	MPO Connector Fiber Configurations Support . . . . .	26
Live Image Screen Features.....	12	To Configure Connector. . . . .	27
Touch Screen Indicators and Buttons Functionality .....	12	Bluetooth Settings.....	28
Understanding Zoom Level and Fiber Position in MPO Connector.....	13	Enabling Bluetooth and Pairing to another Bluetooth device . . . . .	28
Understanding MPO Connector Key Orientation Settings.....	14	Display & Power Save Settings.....	29
Understanding Fiber Numbering after Image is Captured.....	15	Time and Date Settings .....	30
Capture Button Functionality.....	16	Info Screen.....	30
To Inspect MPO connector .....	16	Last Image.....	31
<b>Captured Image Mode - Understanding Captured Results</b> .....	<b>17</b>	Help Menu.....	31
Captured Image Screen Features .....	17	<b>Managing Inspection Results</b> .....	<b>32</b>
Detailed View of the Currently Selected Fiber.....	18	Saving Results Manually .....	32
Pass/Fail Analysis Details Page.....	19	Creating New Folder & Saving Results to a Newly Created Folder.....	32
Image Information Page.....	20	Saving Results to the Current Folder .....	33
		Saving to an Existing Folder, which is not Current .....	34

**Contact the professionals at Fiber Optic Center for a quote or to get more details.**

[focenter.com](http://focenter.com) • 508-992-6464 | (800) 473-4237 • [sales@focenter.com](mailto:sales@focenter.com)  
23 Centre Street • New Bedford, MA 02740 USA



**Manufacturer:**

AFL

**Product Name:**

AFL FOCIS Lightning2 Single Fiber FFLX Coupler

**Manufacturer Part Number:**

FLTNG2-01-SFC



▶ [Click here for more details on the AFL FOCIS Lightning2 Single Fiber FFLX Coupler](#)

- Using Auto-Save Functionality to Save Captured Results Automatically.....35
- File Manager Functions .....36
  - Opening Saved Image Files for Review.....36
  - Creating New Jobs/Cables/Files.....37
  - Deleting Jobs/Cables/Files .....37
- Sharing Inspection Results .....38**
  - Transferring Results Wirelessly via FlexApp to FlexReports .....38
  - Install FlexApp.....39
  - Enable Bluetooth on your Mobile Device.....39
  - Pair FOCIS Lightning2 to your Mobile Device .....40
  - Auto-send Inspection Results to FlexApp.....41
    - Configure FOCIS Lightning2 to Send Results to Paired Mobile Device .....41
    - Auto-Send Results to Paired Mobile Device. . . . .41
  - Receive Data on your Mobile Device with FlexApp . . . . .42
  - Manually Send Inspection Results to FlexApp.....43
  - Sending Captured Results to FlexScan.....44
    - Automatically Send Captured Inspection Results to FlexScan.....44
    - Manually Send Captured Inspection Results to FlexScan .....44
  - Uploading Inspection Results to FlexReporter .....45
- Generating Reports with FlexReporter Software Suite .....46**
  - Using FlexReports for Downloading Test Results from FlexReporter-Cloud .....46
  - Creating MPO Inspection-only Reports.....47
- Contacts .....48**

**Contact the professionals at Fiber Optic Center for a quote or to get more details.**

[focenter.com](http://focenter.com) • 508-992-6464 | (800) 473-4237 • [sales@focenter.com](mailto:sales@focenter.com)  
23 Centre Street • New Bedford, MA 02740 USA



**Manufacturer:**  
AFL

**Product Name:**  
AFL FOCIS Lightning2 Single Fiber FFLX Coupler

**Manufacturer Part Number:**  
FLTNG2-01-SFC

▶ [Click here for more details on the AFL FOCIS Lightning2 Single Fiber FFLX Coupler](#)

### Safety & Compliance

#### Safety Information

**IMPORTANT!** Proper care in handling should be taken when using any precision optical test equipment. Scratched or contaminated optical connectors can impact the performance of the instrument.

**NOTE!** FOCIS Lightning2 contains no user serviceable parts. This instrument must be returned to AFL or authorized agents for repair.

**IMPORTANT!** To ensure accurate measurements and operation, it is important to keep connector end-faces on the fiber under test clean.

**CAUTION!** Never view a live fiber. Never look directly into the optical outputs of fiber optic network equipment, test equipment, patch cords and jumpers. Laser radiation is harmful to eyes.

**WARNING!** Use only the specified AC adapter. Use of another type of AC adapter can damage the instrument and create the danger of fire and electrical shock.

**WARNING!** To avoid the danger of fire and electrical shock:

- Never use a voltage that is different from that for which the AC adapter is rated.
- Do not plug the unit into a power outlet that is shared by other devices.
- Never modify the power cord or excessively bend, twist, or pull it.
- Do not allow the power cord to become damaged. Do not place heavy objects on the power cord or expose it to heat.
- Never touch the AC adapter while your hands are wet.
- Should the power cord become seriously damaged (internal wiring exposed or shorted), contact the manufacturer to request servicing.

**NOTE!** Refer to your company's safety procedures when working with optical systems.

**NOTE!** Follow your company's approved cleaning procedures.

#### Standards Compliance Information

**AFL Test & Inspection FOCIS Lightning2 contains a Wi-Fi transceiver.**

FCC ID: 2ANTH-FLGHTN18

IC: 23261-FLGHTN18

**NOTE:** This equipment has been tested and found to comply with the limits of Part 15 of the FCC Rules. These limits are designed to provide reasonable

protection against harmful interference in a residential installation. This equipment generates, uses and can radiate radio frequency energy and, if not installed and used in accordance with the instructions, may cause harmful interference to radio communications. However, there is no guarantee that interference will not occur in a particular installation. If this equipment does cause harmful interference to radio or television reception, which can be determined by turning the equipment off and on, the user is encouraged to try to correct the interference by one or more of the following measures:

- Reorient or relocate the receiving antenna.
- Increase the separation between the equipment and receiver.
- Connect the equipment into an outlet on a circuit different from that to which the receiver is connected.
- Consult the dealer or an experienced radio/Technician for help.

**FCC Part 15 Clause 15.21**

Changes or modifications not expressly approved by the party responsible for compliance could void the user's authority to operate the equipment.

**ISED RF Exposure Guidance Statement:**

- In order to comply with FCC/ISED RF Exposure requirements, this device must be installed to provide at least 20 cm separation from the human body at all times.
- Afin de se conformer aux exigences d'exposition RF FCC / ISED, cet appareil doit être installé pour fournir au moins 20 cm de séparation du corps humain en tout temps.

**NOTE:** The AFL FOCIS Lightning2 complies with Industry Canada RSS 247 standard. See RSS GEN 7.1.5. The term "IC:" before the certification/ registration number only signifies that registration was performed based on a Declaration of Conformity indicating that Industry Canada technical specifications were met. The term "IC:" before the certification/registration number does not imply that Industry Canada approved the equipment.

Le FOCIS Lightning2 d'AFL est conforme à la norme d'Industrie Canada RSS 247. Voir RSS GEN 7.1.5. Le terme "IC:" avant le numéro de certification/ enregistrement signifie seulement que l'enregistrement a été effectué sur la base d'une déclaration de conformité indiquant que les spécifications techniques d'Industrie Canada ont été rencontrées. Le terme "IC:" avant le numéro de certification/enregistrement n'implique pas qu'Industrie Canada a approuvé l'équipement.

**Contact the professionals at Fiber Optic Center for a quote or to get more details.**

[focenter.com](http://focenter.com) • 508-992-6464 | (800) 473-4237 • [sales@focenter.com](mailto:sales@focenter.com)

23 Centre Street • New Bedford, MA 02740 USA

**Manufacturer:**

AFL

**Product Name:**

AFL FOCIS Lightning2 Single Fiber FFLX Coupler

**Manufacturer Part Number:**

FLTNG2-01-SFC

▶ [Click here for more details on the AFL FOCIS Lightning2 Single Fiber FFLX Coupler](#)

**ISED RSS Notice**

This device complies with Industry Canada's licence-exempt RSSs. Operation is subject to the following two conditions:

- This device may not cause interference;
- This device must accept any interference, including interference that may cause undesired operation of the device.
- Le présent appareil est conforme aux CNR d'Industrie Canada applicables aux appareils radio exempts de licence. L'exploitation est autorisée aux deux conditions suivantes:
- l'appareil ne doit pas produire de brouillage;
- l'appareil doit accepter tout brouillage radioélectrique subi, même si le brouillage est susceptible d'en compromettre le fonctionnement.

**Contact the professionals at Fiber Optic Center for a quote or to get more details.**

[focenter.com](http://focenter.com) • 508-992-6464 | (800) 473-4237 • [sales@focenter.com](mailto:sales@focenter.com)

23 Centre Street • New Bedford, MA 02740 USA



**Manufacturer:**  
AFL

**Product Name:**  
AFL FOCIS Lightning2 Single Fiber FFLX Coupler

**Manufacturer Part Number:**  
FLTNG2-01-SFC

▶ [Click here for more details on the AFL FOCIS Lightning2 Single Fiber FFLX Coupler](#)

### General Information

AFL's FOCIS Lightning<sup>2</sup> Fiber Optic Connector Inspection System, paired with FlexApp comprise a complete fiber optic connector inspection and workflow and data management solution.

### Product Overview

FOCIS Lightning<sup>2</sup> is a self-contained multi-fiber connector inspection probe with integrated screen. It is intended specifically for the inspection of multi-fiber connectors and bulkheads such MPO and MTP<sup>®</sup> including multi-row varieties. The FOCIS Lightning<sup>2</sup> can perform industry standard and user-defined end-face cleanliness analysis at a rate of about 1 second per fiber. Lightning stores connector level and individual fiber images, analysis, overlays, and zones tables locally and provides both Wi-Fi and Bluetooth wireless links. The AFL FlexApp (iOS and Android) provides a comprehensive and user-friendly feature set as well as connectivity with AFL's cloud-based FlexReporter workflow automation platform.

**FlexReporter Software Suite** works with AFL Test and Inspection instruments to provide a simple-to-use, high performance cloud enabled reporting platform. FlexReporter combines FlexApp – a mobile App that wirelessly transfer test results to FlexReporter-Cloud from the field with a fast, comprehensive, 3-step reporting solution – FlexReports PC software.

**FlexReports** is a Windows<sup>®</sup>-compatible PC software that provides comprehensive test results analysis and reporting for AFL FlexScan OTDRs, FOCIS inspection systems, OLTS, and OPM products. It is available in both Basic and Advanced versions.

FlexReports Basic software version enables users to quickly view and analyze results. It allows users to generate simple single-fiber OTDR and OLTS reports and includes a 60-day Advanced software and OTDR Trace Batch Editor license trial.

FlexReports Advanced is a full featured reporting and post-processing solution for generation of professional acceptance reports using Industry Standards. It enables users to generate reports showing dual-wavelength traces and event tables, end-face image, event map and loss data for each fiber. Users can apply Pass/Fail thresholds to OTDR events and OLTS measurements, and create and apply application rules per Industry Standards. FlexReports OTDR Trace Batch Editor enables users to edit and analyze multiple trace files simultaneously.

FlexApp is a mobile Android and iOS App that supports AFL's FlexScan<sup>®</sup>

OTDRs and FOCIS connector inspection products. FlexApp wirelessly transfers test results from any FlexScan OTDR or FOCIS inspection probe directly to FlexReporter-Cloud from the field for subsequent analysis, editing, and reports generation with FlexReports PC software.

### Warranty Terms and Conditions

AFL Test and Inspection products are warranted against defective material and workmanship for a period of (1) one year from the date of delivery to the end user. Optional Extended Warranty starts at the end of the standard (1) one year warranty period. Any product that is found defective within the warranty period, will (at the discretion of AFL) be repaired or replaced. Warranty will be voided if the product has been repaired or altered by other than an authorized AFL repair facility or when it has been subjected to misuse, negligence, or accident.

In no case shall AFL liabilities exceed the original purchase price.

**Contact the professionals at Fiber Optic Center for a quote or to get more details.**

[focenter.com](http://focenter.com) • 508-992-6464 | (800) 473-4237 • [sales@focenter.com](mailto:sales@focenter.com)

23 Centre Street • New Bedford, MA 02740 USA

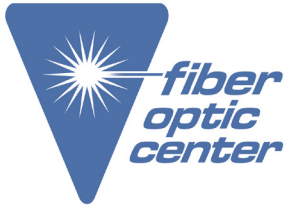

**Manufacturer:**

AFL

**Product Name:**

AFL FOCIS Lightning2 Single Fiber FFLX Coupler

**Manufacturer Part Number:**

FLTNG2-01-SFC



▶ Click here for more details on the AFL FOCIS Lightning2 Single Fiber FFLX Coupler

- When the Settings screen is displayed, touch Info to see the following information:
  - Device name
  - Serial number
  - Controller version number
  - User Interface version number
  - US Patent - #9,217,688
  - Bluetooth version number
- Touch Back to return to previous screen, or you may press Capture button to return to the Live Image mode.

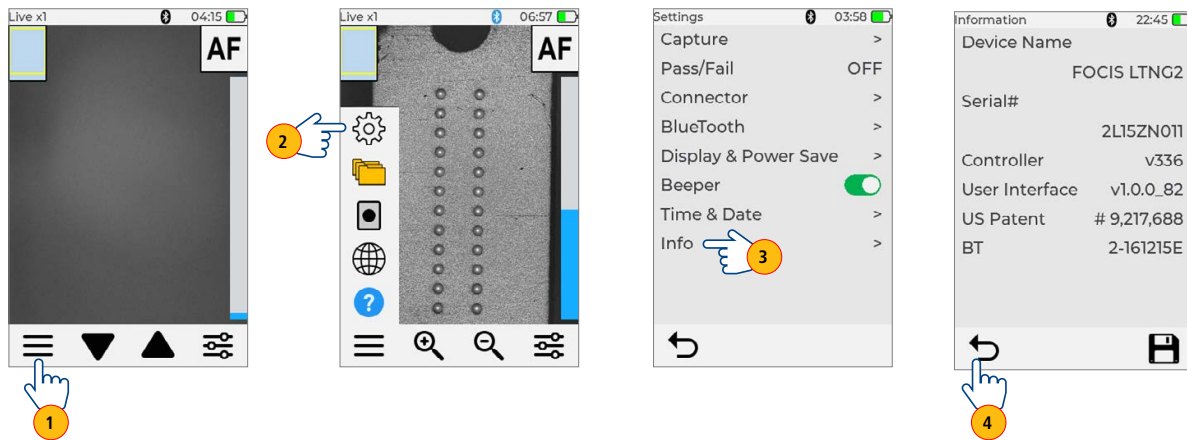

**Contact the professionals at Fiber Optic Center for a quote or to get more details.**

[focenter.com](http://focenter.com) • 508-992-6464 | (800) 473-4237 • [sales@focenter.com](mailto:sales@focenter.com)

23 Centre Street • New Bedford, MA 02740 USA

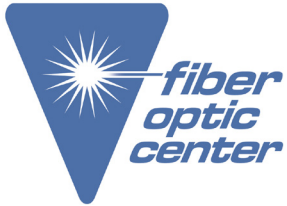

**Manufacturer:**  
AFL

**Product Name:**  
AFL FOCIS Lightning2 Single Fiber FFLX Coupler

**Manufacturer Part Number:**  
FLTNG2-01-SFC

▶ [Click here for more details on the AFL FOCIS Lightning2 Single Fiber FFLX Coupler](#)



**Controls, Display, Interfaces**

- 1. Power Button.
  - 2. Image Capture Button.
  - 3. Touchscreen Display.
  - 4. Optical inspection port.
  - 5. Adapter Tip.
- AFL offers a wide range of inspection adapter tips.  
See [Inspection Adapter Tips catalog](#).
- 6. Protective Dust Cap.
  - 7. USB-C Power / Data Port.
  - 8. Power Charge Indicator.

**Contact the professionals at Fiber Optic Center for a quote or to get more details.**





**Manufacturer:**  
AFL

**Product Name:**  
AFL FOCIS Lightning2 Single Fiber FFLX Coupler

**Manufacturer Part Number:**  
FLTNG2-01-SFC



▶ [Click here for more details on the AFL FOCIS Lightning2 Single Fiber FFLX Coupler](#)

### Powering Up/Down

#### Power-Up

- Press and release the On/Off Button (left side when facing unit).
- Display powers up in Live Image mode.

#### Power-Down

- Press and hold the Power button until display turns off.

### Configure FOCIS Lightning2 to Auto-Off

1. From the Main Menu, touch Settings.
2. Touch Display & Power Save menu option.
3. Display Auto Off pull-down menu.
4. Select the desired power save option: 2 min, 5 min, 10 min, Never.
5. Touch OK to confirm selection.
6. Touch Back to return to the previous screen.

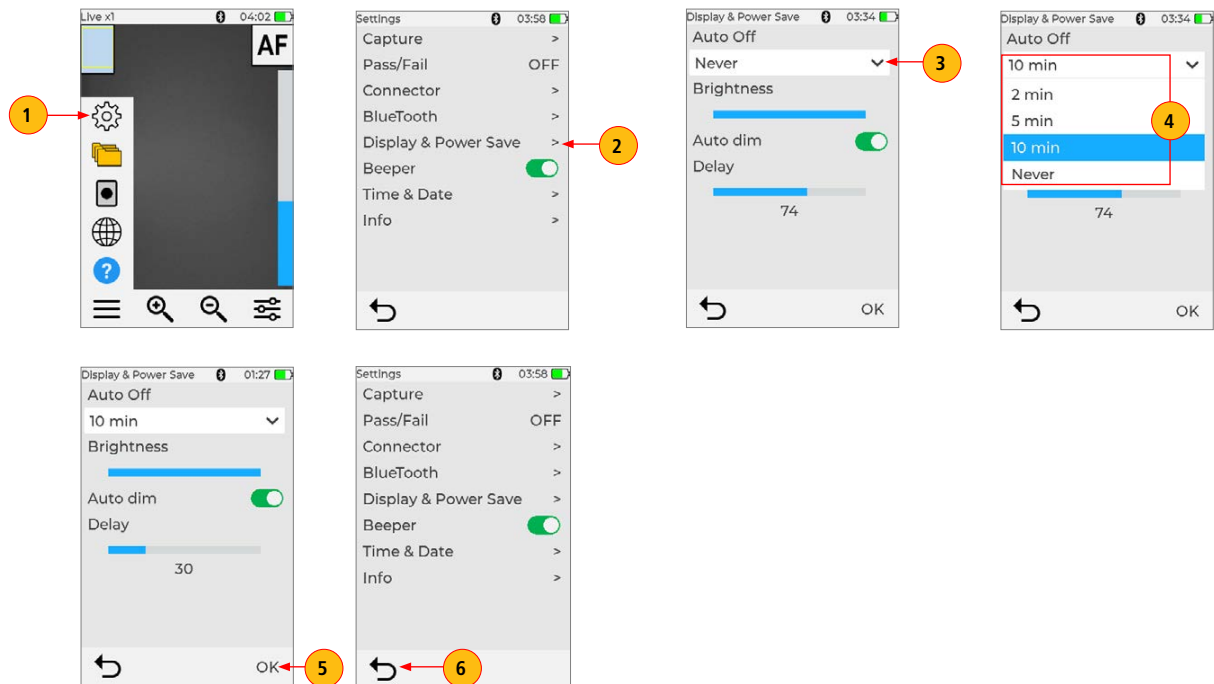

**Contact the professionals at Fiber Optic Center for a quote or to get more details.**

[focenter.com](http://focenter.com) • 508-992-6464 | (800) 473-4237 • [sales@focenter.com](mailto:sales@focenter.com)

23 Centre Street • New Bedford, MA 02740 USA



**Manufacturer:**  
AFL  
**Product Name:**  
AFL FOCIS Lightning2 Single Fiber FFLX Coupler  
**Manufacturer Part Number:**  
FLTNG2-01-SFC

▶ Click here for more details on the AFL FOCIS Lightning2 Single Fiber FFLX Coupler

**Battery Charging and Operation**

- Plug the included AC Charger with USB cable into AC outlet
- Connect charger plug into USB-C port on FOCIS Lightning2
- Power Charge Indicator shows charging status as follows:
  - OFF - AC not plugged in
  - RED solid - Battery is being charged
  - GREEN solid - Battery is fully charged
  - RED/GREEN flashing - Charging error:
    - Verify battery is properly plugged in.
    - Verify correct charger used.
- FOCIS Lightning2 charges while operating

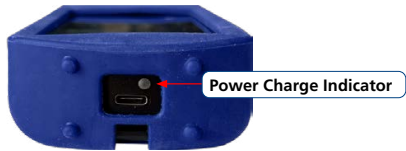

**Battery Operation**

Battery icon indicates battery charge state as follows:

- Charging, not fully charged
- Charging, fully charged
- Battery operation, fully charged
- Battery operation, partially charged
- Battery operation, <15 min operating time remaining
- Battery operation, <15 min operating time remaining, charging

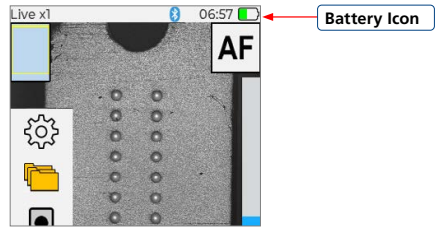

**Properly Installing and Removing Adapter Tips**

**Removing Adapter Tips**

- Probe tips are held in place with a captive nut.
- Turn captive nut clockwise (viewed from front/top).
- Continue until captive nut is free of adapter tip.
- Remove adapter tip by pulling it gently straight off the probe base.

**Installing Adapter Tip**

- While holding adapter tip in place, raise captive nut until it engages with adapter tip threads.
- Turn captive nut counter-clockwise (viewed from front/top).
- Hand-tighten (do not over-tighten).



Contact the professionals at Fiber Optic Center for a quote or to get more details.



**Manufacturer:**  
AFL







**Product Name:**  
AFL FOCIS Lightning2 Single Fiber FFLX Coupler

**Manufacturer Part Number:**  
FLTNG2-01-SFC



▶ [Click here for more details on the AFL FOCIS Lightning2 Single Fiber FFLX Coupler](#)

**Available Inspection Adapter Tips**

Image	AFL NO.	Tip ID	Application	MPO Type	UPC / APC	Keying
	FLTNG-01-M12U	M12U	Inspect through MPO Bulkhead	MPO-12/24	UPC	MPO-12 Key
	FLTNG-01-M12A	M12A		MPO-12/24	APC	MPO-12 Key
	FLTNG-01-MPOA	MPOA		MPO-12/24 MPO-16/32	APC	No Key
	FLTNG-01-M16U	M16U		MPO-16/32	UPC	MPO-16 Key
	FLTNG-01-MPOU	MPOU		MPO-12/24 MPO-16/32	UPC	No Key
	FLTNG-01-MPU	MPU		MPO-12/24 MPO-16/32	UPC	Partial Key - enables use in both MPO-12 and MPO-16 inspection applications
	FLTNG-01-ALCM	ALCM		Extended adapter tip for LC/APC bulkhead		APC
	FLTNG-01-ULCM	ULCM	Extended adapter tip for LC/UPC bulkhead		UPC	
	FLTNG2-01-SFC	SFC	Single Fiber	SFC + any FOCIS Flex Adapter Tip		

**Contact the professionals at Fiber Optic Center for a quote or to get more details.**

[focenter.com](http://focenter.com) • 508-992-6464 | (800) 473-4237 • [sales@focenter.com](mailto:sales@focenter.com)  
23 Centre Street • New Bedford, MA 02740 USA



**Manufacturer:**  
AFL

**Product Name:**  
AFL FOCIS Lightning2 Single Fiber FFLX Coupler

**Manufacturer Part Number:**  
FLTNG2-01-SFC

▶ [Click here for more details on the AFL FOCIS Lightning2 Single Fiber FFLX Coupler](#)

**Live Image Mode - Inspecting MPO Connector**

**Live Image Screen Features**

FOCIS Lightning2 powers-up in the Live Image mode screen. Users can always display the Live Image screen (from any other mode/screen) by pressing the Capture button once or by touching Back  $\square$  enough times.

**Touch Screen Indicators and Buttons Functionality**

- Current Zoom level indicator** — 'x1', 'x2', 'x4', or 'x8'. Zoom level is controlled by touching Zoom buttons.
- Fiber position** — Shows fiber position in MPO connector.  
See ["Understanding Zoom Level and Fiber Position in MPO Connector", page 13.](#)
- AF label/touch screen button** — indicates Auto Focus On/Off, as set in Menu > Settings > Capture screen.  
See ["To Enable Auto Focus", page 22.](#)
  - AF label is displayed in **Black** when Auto Focus is enabled -  $\bullet$ .
  - AF label is displayed in **Red** when Auto Focus is disabled -  $\circ$ .
  - The user may touch **AF/AF** to auto focus once.
- Bluetooth icon** — indicates if FOCIS Lightning<sup>®</sup>2 is paired with Android and iOS devices.  
See ["Bluetooth Settings", page 28:](#)
  - When displayed in Blue  $\text{BT}$  - Bluetooth enabled.
  - When displayed in Black  $\text{BT}$  - Bluetooth disabled.
- Time stamp** — displays current time in 24-hour format. See ["Time and Date Settings", page 30.](#)
- Battery icon** — indicates battery charge state. See ["Battery Charging and Operation", page 10.](#)
- Menu icon/touch screen button** — Touch to display the Main Menu that allows the user to set preferences, manage saved test results, and perform other non-test functions.
- Zoom In button** — Touch to increase image magnification: x1, x2, x4, x8.
- Zoom Out button** — Touch to decrease image magnification: x8, x4, x2, x1.  
See ["Understanding Zoom Level and Fiber Position in MPO Connector", page 13.](#)
- Brightness/Manual Focus/Zoom toggle control**—Touch to display Brightness/Manual Focus/Zoom toggle sub-menu.
- Focus level** — Vertical Blue slider indicates the current focus level relative to focus range.
  - Touch and drag up/down to manually adjust focus.
  - Blue section on the slider indicates the current focus level relative to focus range.

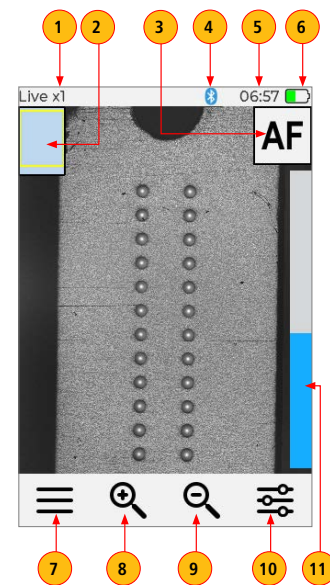

**Contact the professionals at Fiber Optic Center for a quote or to get more details.**



**Manufacturer:**  
AFL

**Product Name:**  
AFL FOCIS Lightning2 Single Fiber FFLX Coupler

**Manufacturer Part Number:**  
FLTNG2-01-SFC

▶ [Click here for more details on the AFL FOCIS Lightning2 Single Fiber FFLX Coupler](#)

**Understanding Zoom Level and Fiber Position in MPO Connector**

FOCIS Lightning2 provides four zoom levels: x1, x2, x4, x8. Zoom level is controlled by Magnifying Glass icon.

1. Touch Zoom In icon to increase Zoom level.
2. Touch Zoom Out icon to decrease Zoom level.
3. Note that Zoom label changes to indicate the currently selected zoom level.
4. Also, note that Fiber Position in MPO Connector changes depending on the current zoom level.

Zoom x1 covers largest area ← Higher zoom covers smaller areas → Zoom x8 covers smallest area

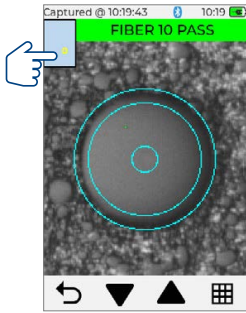
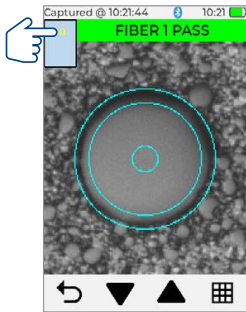
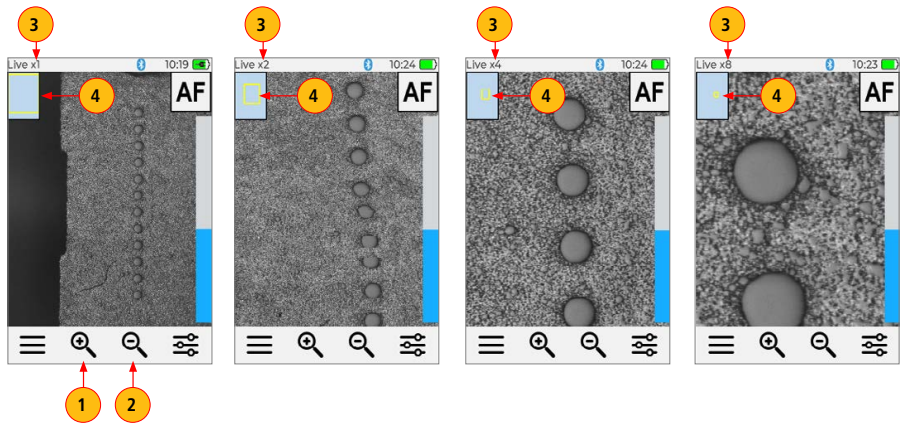

Captured Image Mode: Relative position of fiber in MPO connector (Note: example is for Key Up)

**Contact the professionals at Fiber Optic Center for a quote or to get more details.**

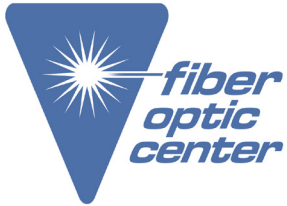

**Manufacturer:**  
AFL

**Product Name:**  
AFL FOCIS Lightning2 Single Fiber FFLX Coupler

**Manufacturer Part Number:**  
FLTNG2-01-SFC



▶ [Click here for more details on the AFL FOCIS Lightning2 Single Fiber FFLX Coupler](#)

#### Understanding MPO Connector Key Orientation Settings

The goal of the MPO Key Up/Down settings is to provide users with the correct information about fiber numbering (pinout) after the image capture.

When inspecting MPO connector using bulkheads with **opposed keys**, it is **important to define the MPO key orientation** in the in Live Image mode prior to the Image Capture.

At power-up, FOCIS Lightning\*2 defaults to key Up orientation.

The MPO connector key orientation (key Position) is set in Main Menu > Settings > Capture.

1. In the Live Image screen, touch Menu, then touch Settings.
2. In the Settings screen, touch Capture.
3. In the Settings screen, touch the Key Position option Arrow Down icon.
4. From the displayed menu select Up or Down option as required.
5. Touch back to return to previous screen

Note: This setting should be defined in the Live Image mode prior to image capture.

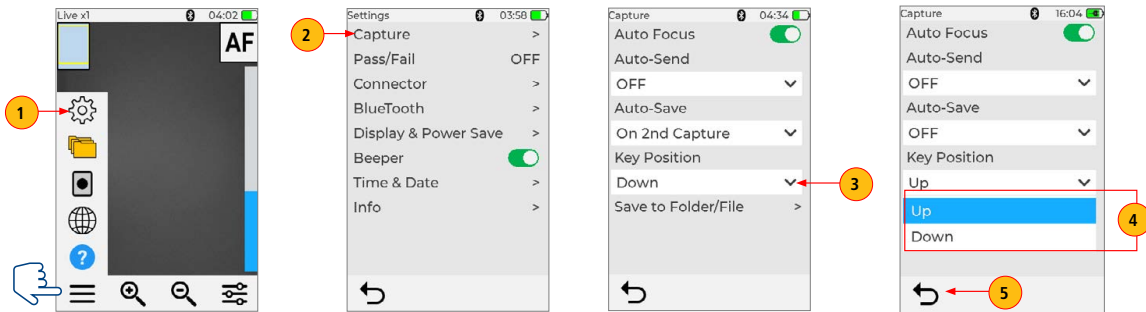

**Contact the professionals at Fiber Optic Center for a quote or to get more details.**

[focenter.com](http://focenter.com) • 508-992-6464 | (800) 473-4237 • [sales@focenter.com](mailto:sales@focenter.com)

23 Centre Street • New Bedford, MA 02740 USA

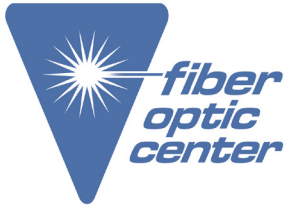

**Manufacturer:**  
AFL

**Product Name:**  
AFL FOCIS Lightning2 Single Fiber FFLX Coupler

**Manufacturer Part Number:**  
FLTNG2-01-SFC



▶ [Click here for more details on the AFL FOCIS Lightning2 Single Fiber FFLX Coupler](#)

#### Understanding Fiber Numbering after Image is Captured

After the inspected fiber end-face image is captured, FOCIS Lightning<sup>2</sup> transitions to the Captured Image mode displaying inspection results with Pass/Fail analysis indication:

- ☐ — Fiber #1 location is indicated by Blue box
- — Passing fiber is indicated by Green circle
- — Failing fiber is indicated by Red circle
- — Not evaluated fiber is indicated by Cyan circle

- When the MPO Key Position is set to Up in the Capture menu (default setup), Fiber #1 is located at top-right as indicated by Blue box.
- When the MPO key orientation is set to Down in the Capture menu, Fiber #1 is located at bottom-left as indicated by Blue box.

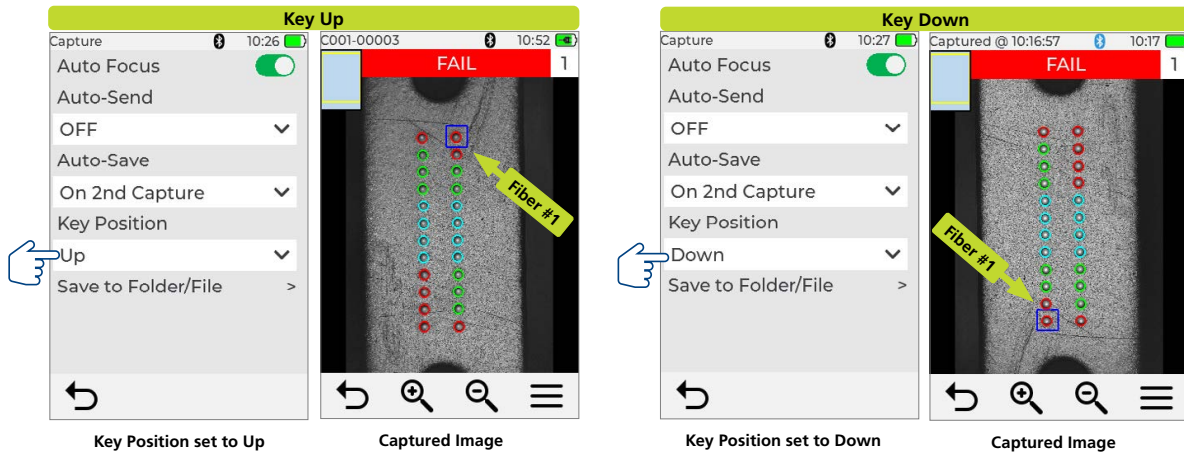

**Contact the professionals at Fiber Optic Center for a quote or to get more details.**

[focenter.com](http://focenter.com) • 508-992-6464 | (800) 473-4237 • [sales@focenter.com](mailto:sales@focenter.com)

23 Centre Street • New Bedford, MA 02740 USA





**Manufacturer:**  
AFL

**Product Name:**  
AFL FOCIS Lightning2 Single Fiber FFLX Coupler

**Manufacturer Part Number:**  
FLTNG2-01-SFC

▶ [Click here for more details on the AFL FOCIS Lightning2 Single Fiber FFLX Coupler](#)

#### Capture Button Functionality

**In the Live Image mode** — Capture button initiates live image capture.

- When **Auto Focus is enabled** and Capture button is pressed:
  - Auto focus is initiated. See ["To Enable Auto Focus", page 22.](#)
  - Image is captured when auto focus completes.
  - Image is analyzed if Pass/Fail analysis enabled. See ["To Configure Pass/Fail Criteria", page 25.](#)
  - FOCIS Lightning<sup>®</sup>2 transitions to Captured Image mode. See ["Captured Image Mode - Understanding Captured Results", page 17.](#)
  - Save and send results to the Bluetooth-paired device if auto-save and auto-send enabled on '1st Capture Key'. See ["To Configure Auto-Send", page 22](#) for details.
  - If auto-save or auto-send enabled on '2nd Capture Key', press the Capture button again to save and/or send. See ["To Configure Auto-Send", page 22.](#)
- When **Auto Focus is disabled** and Capture button is pressed:
  - Image is captured (without adjusting focus)
  - Image is analyzed if Pass/Fail analysis enabled. See ["To Configure Pass/Fail Criteria", page 25.](#)
  - FOCIS Lightning<sup>®</sup>2 transitions to Captured Image mode. See ["Captured Image Mode - Understanding Captured Results", page 17.](#)
  - Save and send results to the Bluetooth-paired device if auto-save and auto-send enabled on '1st Capture Key'. See ["To Configure Auto-Send", page 22](#) for details.
  - If auto-save or auto-send enabled on '2nd Capture Key', press the Capture button again to save and/or send. See ["To Configure Auto-Send", page 22.](#)

**In all other modes** — Capture button is used to return to the Live Image mode.

#### To Inspect MPD connector

1. Turn on FOCIS Lightning2 by pressing the Power button on its left side.
2. Plug male (pins) or female (holes) MPO cable into the appropriate MPO alignment sleeve (bulkhead) with adapter tip appropriate for the cable type.
3. Plug FOCIS Lightning2 adapter tip into the MPO alignment sleeve.
4. The full MPO end-face in 'x1' view mode will be displayed on the FOCIS Lightning2 display in less than two seconds.
5. Press the Capture button to initiate fiber inspection and analysis.

**Contact the professionals at Fiber Optic Center for a quote or to get more details.**

[focenter.com](http://focenter.com) • 508-992-6464 | (800) 473-4237 • [sales@focenter.com](mailto:sales@focenter.com)

23 Centre Street • New Bedford, MA 02740 USA





**Manufacturer:**  
AFL

**Product Name:**  
AFL FOCIS Lightning2 Single Fiber FFLX Coupler

**Manufacturer Part Number:**  
FLTNG2-01-SFC



▶ [Click here for more details on the AFL FOCIS Lightning2 Single Fiber FFLX Coupler](#)

### Captured Image Mode - Understanding Captured Results

#### Captured Image Screen Features

After the fiber end-face image is captured, FOCIS Lightning2 transitions to the Captured Image mode displaying inspection results. Below is the description of features seen on the Captured Image screen.

- File name** — When a saved image is shown, displays file name (e.g.C001-00003). When unsaved image is shown, displays file name as 'Captured @ hh:mm:ss'.
- Fiber position** — Shows fiber position in MPO connector. See [“Understanding Zoom Level and Fiber Position in MPO Connector”, page 13.](#)
- Inspection analysis status** — (Pass or Fail): shown only if the Pass/Fail option is enabled in Settings. See [“To Configure Pass/Fail Criteria”, page 25](#)
- Bluetooth Icon** — indicates if FOCIS Lightning2 is paired with Android and iOS devices. See [“Example IEC Rule”, page 24:](#)
  - When displayed in Blue Bluetooth enabled.
  - When displayed in Black Bluetooth disabled.
- Time stamp** — displays current time in 24-hour format. See [“Time and Date Settings”, page 30.](#)
- Battery icon** — indicates battery charge state. See [“Battery Charging and Operation”, page 10.](#)
- Fiber number** — shows number of the currently selected fiber.
- Indicator of the selected fiber** — blue box indicates fiber that is the currently selected for detailed view.
- Menu button** — touch to display the sub-menu: Detail View / Info View / Edit/Save / Share.
- Zoom Out button** — Touch to decrease image magnification: x8, x4, x2, x1. See [“Understanding Zoom Level and Fiber Position in MPO Connector”, page 13.](#)
- Zoom In button** — Touch to increase image magnification: x1, x2, x4, x8.
- Back button** — touch to return to the Live Image mode.

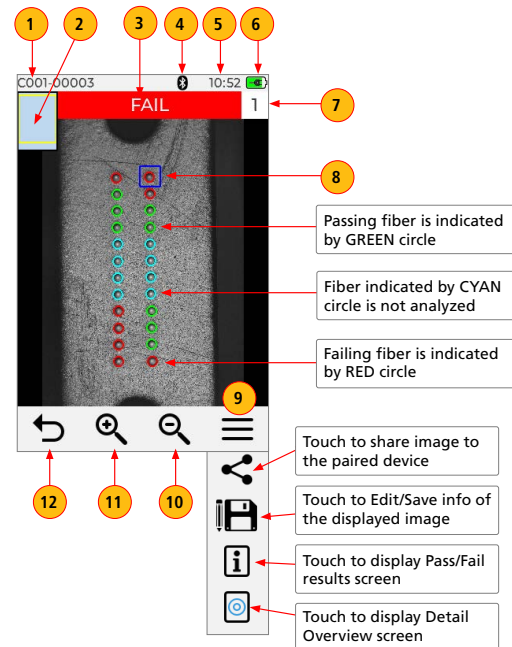

**Contact the professionals at Fiber Optic Center for a quote or to get more details.**

[focenter.com](http://focenter.com) • 508-992-6464 | (800) 473-4237 • [sales@focenter.com](mailto:sales@focenter.com)

23 Centre Street • New Bedford, MA 02740 USA



**Manufacturer:**  
AFL

**Product Name:**  
AFL FOCIS Lightning2 Single Fiber FFLX Coupler

**Manufacturer Part Number:**  
FLTNG2-01-SFC

▶ [Click here for more details on the AFL FOCIS Lightning2 Single Fiber FFLX Coupler](#)

**Detailed View of the Currently Selected Fiber**

1. **Screen title:** displays file name (e.g. COO1-0002) if saved image is shown or 'Captured @ hh:mm:ss' if unsaved image is shown.
2. **Fiber Analysis status:** indicates Pass or Fail and Number of the currently displayed fiber.
3. **Single fiber image:** Touching display will navigate through various detailed views of the currently selected fiber as follows:
  - End-face image with overlay layer shown (default view)
  - End-face image only
  - Overlay only
4. **Toggle button:** touch this button to toggle between Image Details display and Analysis Details display.
5. **Arrow buttons:** touch to navigate through fibers. Direction of navigation through fibers with Up/Down arrows depends on Key Up/Key Down settings.
6. **Back button:** press to return to the MPO Image Overview page.

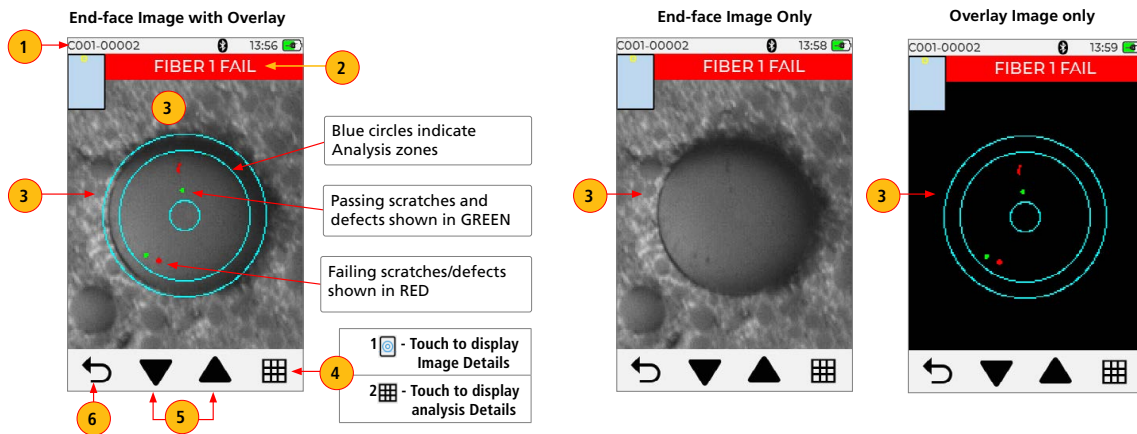

**Contact the professionals at Fiber Optic Center for a quote or to get more details.**



**Manufacturer:**

AFL

**Product Name:**

AFL FOCIS Lightning2 Single Fiber FFLX Coupler

**Manufacturer Part Number:**

FLTNG2-01-SFC



▶ [Click here for more details on the AFL FOCIS Lightning2 Single Fiber FFLX Coupler](#)

**Pass/Fail Analysis Details Page**

1. **Screen Title:** displays File Name (e.g. COO1-0002) if saved image is shown or Captured @ hh:mm:ss if unsaved image is shown.
2. **Fiber Analysis status:** indicates Pass or Fail and Number of the currently displayed fiber.
3. **Analysis Rule:** displays Analysis Rule applied to determine Pass/Fail.
4. **Analysis Zones:** A - core, B - cladding, C - adhesive, D - contact area.
5. **Scratch analysis results for each zone:** reports the number of detected scratches exceeding limit for each region; highlights failed rules in RED.
6. **Defect analysis results for each zone:** reports the number of detected defects exceeding limit for each region; highlights failed rules in RED.
7. **Toggle button:** touch this button to toggle between Image Details display and Analysis Details display.
8. **Arrow buttons:** touch to navigate through fibers.  
Direction of navigation through fibers with Up/Down arrows depends on Key Up/Key Down settings.
9. **Back button:** press to return to the MPO Image Overview page.

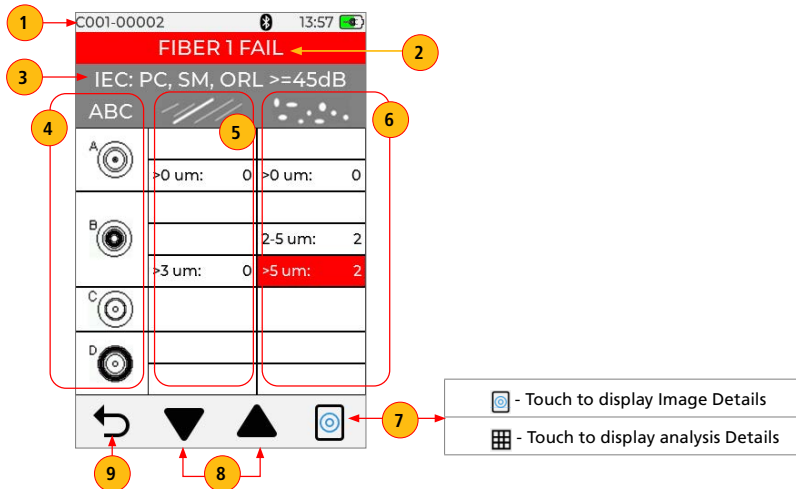

**Contact the professionals at Fiber Optic Center for a quote or to get more details.**

[focenter.com](http://focenter.com) • 508-992-6464 | (800) 473-4237 • [sales@focenter.com](mailto:sales@focenter.com)

23 Centre Street • New Bedford, MA 02740 USA



**Manufacturer:**  
AFL

**Product Name:**  
AFL FOCIS Lightning2 Single Fiber FFLX Coupler

**Manufacturer Part Number:**  
FLTNG2-01-SFC



▶ [Click here for more details on the AFL FOCIS Lightning2 Single Fiber FFLX Coupler](#)

#### Image Information Page

1. **Screen Title:** displays File Name (e.g. COO1-0002) if saved image is shown or Captured @ hh:mm:ss if unsaved image is shown.
2. **Fiber Analysis Status:** indicates Pass or Fail and Number of the currently displayed fiber.
3. **Results ID:** this field displays all information about saved result, Job ID/Scope End/Cable ID/Pair Mode/Pair Type/Connector ID.
4. **Time & Date:** shows time & date of the displayed captured image.
5. **Rule:** indicates applied Pass/Fail analysis rule.
6. **Edit Results ID button:** touch to display editor menu, which allows editing ID parameters as described in references 7-11.
  7. **To edit Job ID/Scope End/Far End/Cable ID/Connector ID:** touch the desired field to edit.
  8. **To edit Pair Mode:** touch to select one of the available option.
  9. **To edit Pair Type:** touch to select one of the available option.  
Note that Pair Type selection options depend on Pair Mode selection.
  10. **To edit destination folder:** if needed, you may touch Folder icon to go to the top level Job/Folder structure.
  11. **Save edits:** when done, touch Floppy icon to save edits.
12. **Back button:** touch to return to the previous screen.

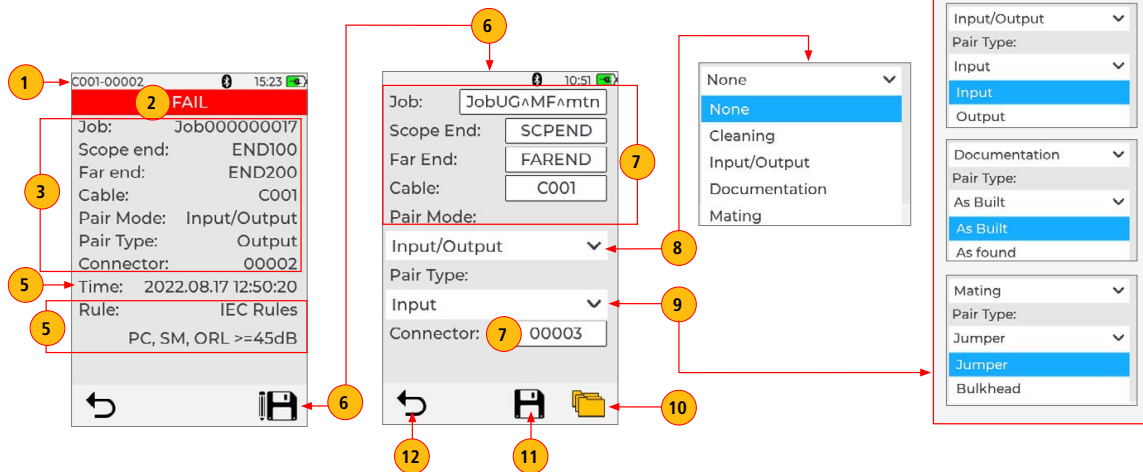

**Contact the professionals at Fiber Optic Center for a quote or to get more details.**

[focenter.com](http://focenter.com) • 508-992-6464 | (800) 473-4237 • [sales@focenter.com](mailto:sales@focenter.com)

23 Centre Street • New Bedford, MA 02740 USA



**Manufacturer:**

AFL

**Product Name:**

AFL FOCIS Lightning2 Single Fiber FFLX Coupler

**Manufacturer Part Number:**

FLTNG2-01-SFC



▶ [Click here for more details on the AFL FOCIS Lightning2 Single Fiber FFLX Coupler](#)

## Settings

### Main Menu

The Main Menu is accessed from Live Image mode by touching the Menu ≡ icon. Main Menu is used to select user preferences, perform general settings, manage saved test results, and perform other non-test functions.

- While in the Main Menu, touch one of the menu item as follows.
  1. **Settings:** Use to configure Capture settings, Auto Focus, Pass/Fail criteria, Connector criteria, Bluetooth, and General settings.
  2. **Results Manager:** Use to navigate and review saved test results.
  3. **Last Image:** Use to recall most recently viewed image.
  4. **Language:** Select the FOCIS Lightning User Interface Language.
  5. **Help:** View help tips regarding UI icons and functionality.
- If a menu item is followed by Right Arrow, touch to display a sub-screen of the selected menu item.
- Touch Back to return to the previous screen.

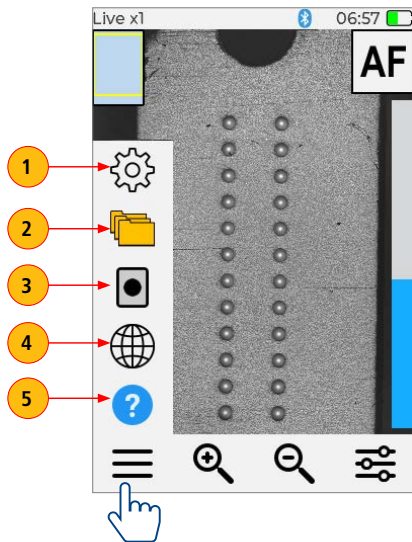

**Contact the professionals at Fiber Optic Center for a quote or to get more details.**

[focenter.com](http://focenter.com) • 508-992-6464 | (800) 473-4237 • [sales@focenter.com](mailto:sales@focenter.com)

23 Centre Street • New Bedford, MA 02740 USA



**Manufacturer:**  
AFL

**Product Name:**  
AFL FOCIS Lightning2 Single Fiber FFLX Coupler

**Manufacturer Part Number:**  
FLTNG2-01-SFC



▶ [Click here for more details on the AFL FOCIS Lightning2 Single Fiber FFLX Coupler](#)

### Settings Menu

Setting menu is accessed from the Live Image mode > Main Menu > Settings. Settings menu provides access to various sub-menus that allows the user to configure image Capture, Pass/Fail analysis, Connector options, enable and pair Bluetooth, enable Power Save, set Time & Date, and view FOCIS Lightning2 Info.

#### Capture Settings

1. Touch Menu, then Touch Settings
2. Touch Capture to display the Capture screen and available settings.

#### To Enable Auto Focus

3. Touch Auto Focus On/Off control to enable or disable  / .

#### To Configure Auto-Send

4. Touch Auto-Send drop-down menu to display available options. Select one of the following: OFF - disable Auto-Send functionality, enable on 1st Capture, or enable on 2nd Capture.

#### To Configure Auto-Save

5. Touch Auto-Save drop-down menu to display available options. Select one of the following: OFF - disable Auto-Save, enable on 1st Capture, or enable on 2nd Capture.

#### To Configure Key Position

6. Touch Key Position drop-down menu to display available options. Select one of the following: Up, Down.

#### To Configure 'Save to' Destination

7. Touch Save to Folder/File. Touch and edit the desired folder/file field.

When Auto-Send/Save is enabled, press Capture from Live Image mode to auto-focus, capture image, analyze pass/fail (if enabled), then send image and pass/fail results to a Bluetooth paired device and save image and pass/fail results to the configured Job/Cable folder.

**Note:** If Auto-Save or Auto-Send on 2nd Capture Key is enabled, you will be prompted to press the Capture button again to save or send. Press the Back button if you do not wish to save or send image.

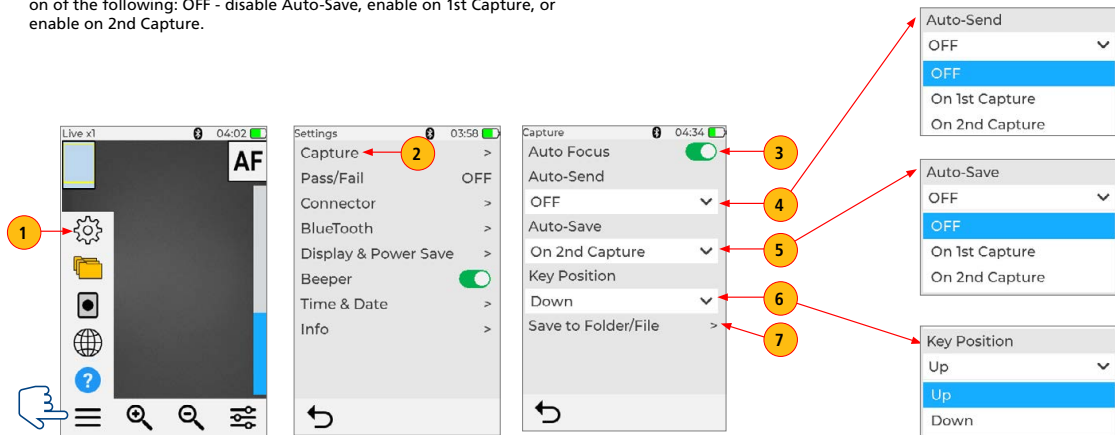

**Contact the professionals at Fiber Optic Center for a quote or to get more details.**

[focenter.com](http://focenter.com) • 508-992-6464 | (800) 473-4237 • [sales@focenter.com](mailto:sales@focenter.com)

23 Centre Street • New Bedford, MA 02740 USA



**Manufacturer:**

AFL

**Product Name:**

AFL FOCIS Lightning2 Single Fiber FFLX Coupler

**Manufacturer Part Number:**

FLTNG2-01-SFC



▶ [Click here for more details on the AFL FOCIS Lightning2 Single Fiber FFLX Coupler](#)

**Pass/Fail Settings**

**Understanding Pass/Fail Settings**

**IEC Pass/Fail Analysis**

IEC 61300-3-35 defines connector inspection pass/fail criteria.

Pass/Fail criteria depends on:

- Fiber type (SMF or MMF).
- Connector end face regions:
  - **A region:** Core
  - **B region:** Cladding
  - **C region:** Adhesive (between cladding and ferrule)
  - **D region:** Physical contact area
- Type of end face flaw:
  - Scratches
  - Defects (contamination, particles, chips)
- Size of flaw.

IEC 61300-3-35 for multi-fiber MPO/MTP connectors only defines the following regions (or zones):

- **A region:** Core
- **B region:** Cladding

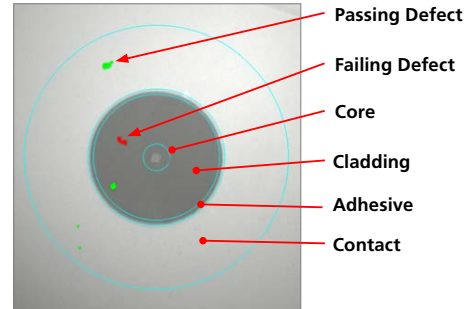

**Contact the professionals at Fiber Optic Center for a quote or to get more details.**

[focenter.com](http://focenter.com) • 508-992-6464 | (800) 473-4237 • [sales@focenter.com](mailto:sales@focenter.com)

23 Centre Street • New Bedford, MA 02740 USA

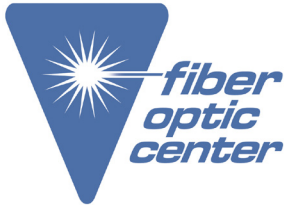

**Manufacturer:**  
AFL

**Product Name:**  
AFL FOCIS Lightning2 Single Fiber FFLX Coupler

**Manufacturer Part Number:**  
FLTNG2-01-SFC



▶ [Click here for more details on the AFL FOCIS Lightning2 Single Fiber FFLX Coupler](#)

**Example IEC Rule**

Shown below is the display when the IEC rule for single-mode PC connector with return loss  $\geq 45$  dB is selected. The table identifies the number of scratches or defects of a certain size, which may be allowed in each of the core, cladding, and contact regions.

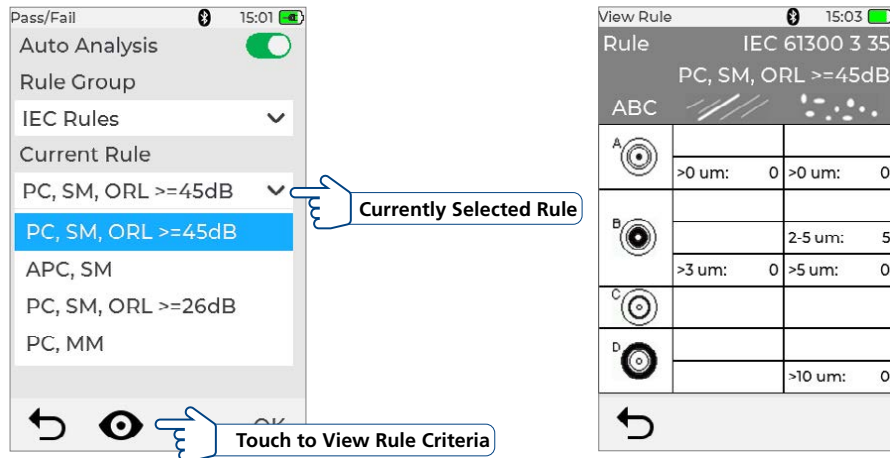

Region	Scratch	Defect
A: Core	>0 $\mu\text{m}$ : 0 No scratches >0 $\mu\text{m}$ allowed	>0 $\mu\text{m}$ : 0 No defects >0 $\mu\text{m}$ allowed
B: Cladding		2-5 $\mu\text{m}$ : 5 Up to 5 defects 2-5 $\mu\text{m}$ diameter allowed
	>3 $\mu\text{m}$ : 0 No scratches >3 $\mu\text{m}$ allowed	>5 $\mu\text{m}$ : 0 No defects >3 $\mu\text{m}$ allowed
C: Adhesive	Blank (No limitations)	Blank (No limitations)
D: Contact	Blank (No limitations)	0 $\geq 10 \mu\text{m}$ No defects $\geq 10 \mu\text{m}$ allowed

**Contact the professionals at Fiber Optic Center for a quote or to get more details.**





**Manufacturer:**  
AFL

**Product Name:**  
AFL FOCIS Lightning2 Single Fiber FFLX Coupler

**Manufacturer Part Number:**  
FLTNG2-01-SFC



▶ [Click here for more details on the AFL FOCIS Lightning2 Single Fiber FFLX Coupler](#)

#### To Configure Pass/Fail Criteria

Pass/Fail menu is accessed from the Live Image mode > Main Menu > Settings.

1. Touch Menu, then Touch Settings.
2. Touch Pass/Fail to display the Pass/Fail analysis options.
3. Enable Auto Analysis (if disabled): Touch Auto Analysis On/Off  control to enable.
4. Select Rule Group: Touch the Rule Group pull-down menu to display the available options and select the desired Group.  
Note: User Rules may be edited.
5. Select Current Rule: Touch the Current Rule pull-down menu to display the available Rules and select the desired Rule.
6. View Rule criteria if needed: Touch the Eye icon to view the currently selected Rule.
7. Touch Back to return to the previous screen. Or, you may press Capture button to return to live mode.

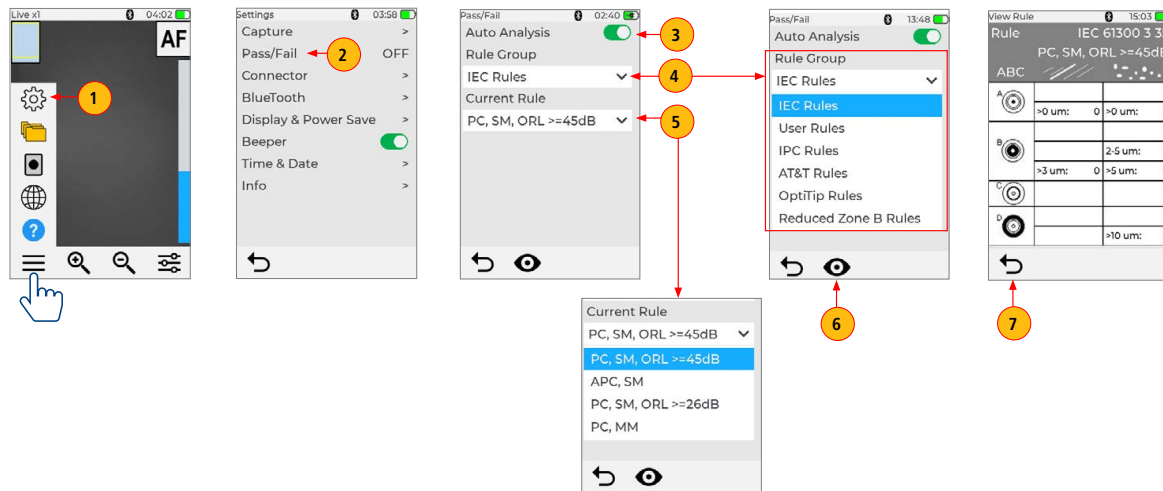

**Contact the professionals at Fiber Optic Center for a quote or to get more details.**

[focenter.com](http://focenter.com) • 508-992-6464 | (800) 473-4237 • [sales@focenter.com](mailto:sales@focenter.com)

23 Centre Street • New Bedford, MA 02740 USA



**Manufacturer:**  
AFL

**Product Name:**  
AFL FOCIS Lightning2 Single Fiber FFLX Coupler

**Manufacturer Part Number:**  
FLTNG2-01-SFC

▶ [Click here for more details on the AFL FOCIS Lightning2 Single Fiber FFLX Coupler](#)

**Connector Settings**

**MPO Connector Fiber Configurations Support**

FOCIS Lightning2 supports all fiber configurations of MPO-12 up to two rows, with "base 8", "base 10", and "base 12" fiber configurations per row as well as other MPO options.

Note that solid circle is "X" or an unused fiber, and open circle is an active or used fiber and will be analyzed by FOCIS Lightning2.

MPO configurations options	MPO-8 fiber configurations	MPO-12 fiber configurations	MPO-24 fiber configurations

○ – active (used) fiber  
X – dark (unused) fiber

**Single Row MPO Fiber Configuration Example**

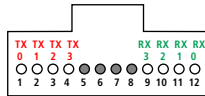

**Dual Row MPO Fiber Configuration Example**

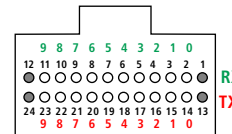

**Contact the professionals at Fiber Optic Center for a quote or to get more details.**



**Manufacturer:**  
AFL

**Product Name:**  
AFL FOCIS Lightning2 Single Fiber FFLX Coupler

**Manufacturer Part Number:**  
FLTNG2-01-SFC



▶ [Click here for more details on the AFL FOCIS Lightning2 Single Fiber FFLX Coupler](#)

FOCIS Lightning2 supports multiple single fiber and MPO connector types.

**To Configure Connector**

**Note:** It is important to set the correct MPO fiber configuration prior to inspection! If the MPO connector setting is not configured correctly, the auto-analysis results will likely show "false negatives" and possibly "false positives".

**To Configure MPO Connector**

1. From the Main Menu > Settings, touch Connector to display the Connector menu, which shows a list of the available Connector options.
2. Touch MPO option .
3. From the displayed list, touch the desired MPO connector configuration to select it.
  - Note that for MPO-8/-12/-24 options, you would need to select fiber configuration.
4. **Important:** Note that selected MPO configuration (for MPO-8/ for MPO-12/for MPO-24) is displayed at the bottom of Connector menu.

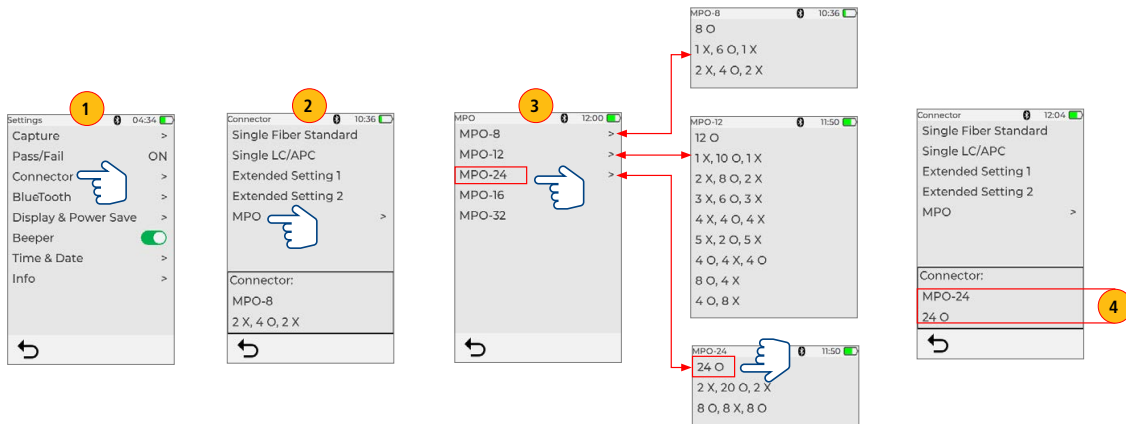

**Contact the professionals at Fiber Optic Center for a quote or to get more details.**

[focenter.com](http://focenter.com) • 508-992-6464 | (800) 473-4237 • [sales@focenter.com](mailto:sales@focenter.com)  
23 Centre Street • New Bedford, MA 02740 USA



**Manufacturer:**  
AFL

**Product Name:**  
AFL FOCIS Lightning2 Single Fiber FFLX Coupler

**Manufacturer Part Number:**  
FLTNG2-01-SFC



▶ [Click here for more details on the AFL FOCIS Lightning2 Single Fiber FFLX Coupler](#)

### Bluetooth Settings

#### Enabling Bluetooth and Pairing to another Bluetooth device

FOCIS Lightning®2 can be paired with Android device, iOS device, and FlexScan OTDR.

1. In the Live Image screen, touch Menu, then touch Settings.
2. In the Settings screen, touch Bluetooth.
3. Touch the Search icon to see all Bluetooth enabled devices in range.
4. When a list of visible devices is shown, touch the device to pair with.
5. Touch the Link icon to initiate pairing.
6. Confirm pairing on FOCIS Lightning2.
7. Confirm pairing on your mobile device.
8. FOCIS Lightning2 will report successful pairing and Bluetooth icon changes from black to blue.

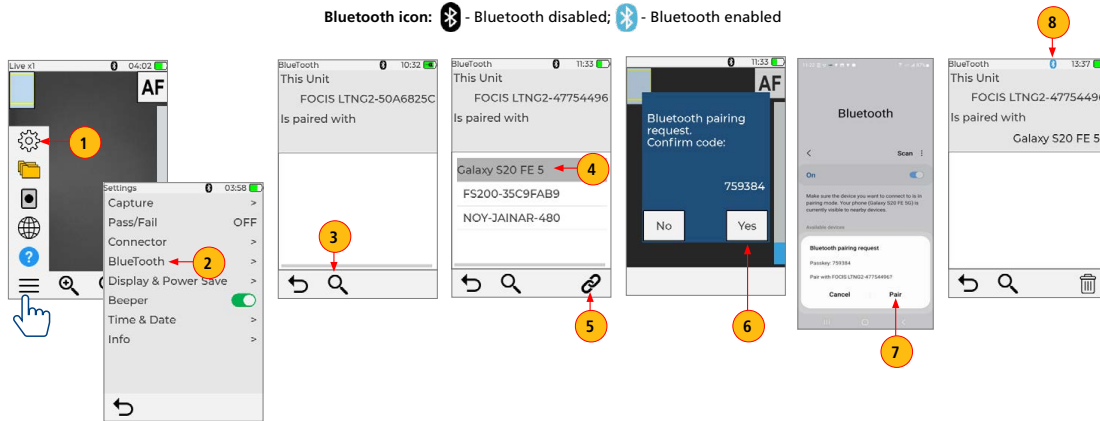

**Contact the professionals at Fiber Optic Center for a quote or to get more details.**

[focenter.com](http://focenter.com) • 508-992-6464 | (800) 473-4237 • [sales@focenter.com](mailto:sales@focenter.com)

23 Centre Street • New Bedford, MA 02740 USA



**Manufacturer:**  
AFL

**Product Name:**  
AFL FOCIS Lightning2 Single Fiber FFLX Coupler

**Manufacturer Part Number:**  
FLTNG2-01-SFC



▶ [Click here for more details on the AFL FOCIS Lightning2 Single Fiber FFLX Coupler](#)

#### Display & Power Save Settings

1. In the Live Image screen, touch Menu, then touch Settings.
2. In the Settings screen, touch Display & Power Save.
3. Touch the Auto Off option Arrow Down icon.
4. From the displayed Auto Off sub-menu, touch the desired Auto Off option to select: 2 min, 5 min, 10 min, Never.
5. Touch Brightness slider to increase or decrease brightness level.
6. Touch the Auto dim On/Off control to enable/disable auto-dimming.
7. When Auto dim is enabled, touch the Auto dim slider to increase/decrease auto dim time.  
**Note:** dimming display extends battery life!
8. Touch OK to confirm settings and return to the Settings screen.

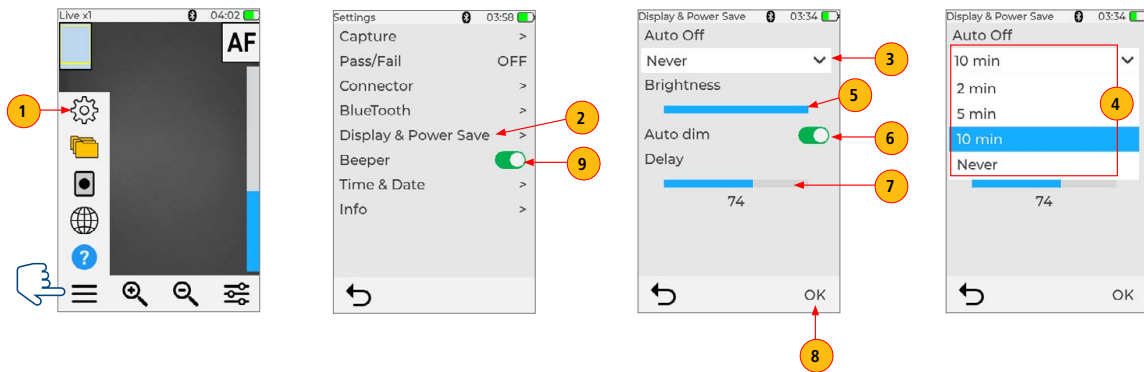

**Contact the professionals at Fiber Optic Center for a quote or to get more details.**

[focenter.com](http://focenter.com) • 508-992-6464 | (800) 473-4237 • [sales@focenter.com](mailto:sales@focenter.com)

23 Centre Street • New Bedford, MA 02740 USA



**Manufacturer:**  
AFL

**Product Name:**  
AFL FOCIS Lightning2 Single Fiber FFLX Coupler

**Manufacturer Part Number:**  
FLTNG2-01-SFC



▶ [Click here for more details on the AFL FOCIS Lightning2 Single Fiber FFLX Coupler](#)

#### Time and Date Settings

1. In the Live Image screen, touch Menu, then touch Settings.
2. In the Settings screen, touch Time & Date to display the setup menu.
3. Date setup is displayed by default: touch the desired YYYY-MM-DD to select.
4. Touch Set Time to display the setup screen for Time.
5. Touch the desired HH:MM to select. **Note:** Time setting is in 24-hour time format.
6. Touch OK to confirm Date/Time settings and return to the Settings screen.

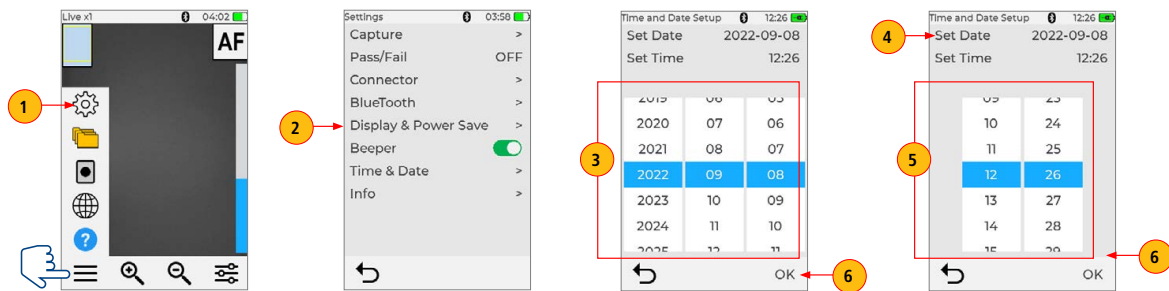

#### Info Screen

7. To access Info screen: In the Settings screen, touch Info.

Info screen displays the following information:

- Device name
- Serial number
- Controller version number
- User Interface version number
- US Patent - #9,217,688
- Bluetooth version number

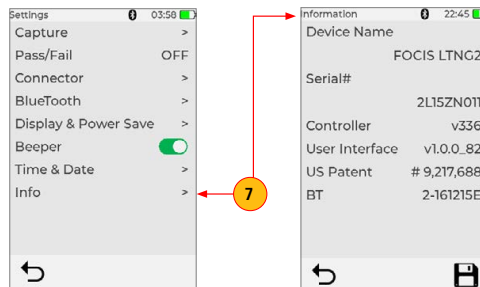

**Contact the professionals at Fiber Optic Center for a quote or to get more details.**

[focenter.com](http://focenter.com) • 508-992-6464 | (800) 473-4237 • [sales@focenter.com](mailto:sales@focenter.com)

23 Centre Street • New Bedford, MA 02740 USA



**Manufacturer:**  
AFL

**Product Name:**  
AFL FOCIS Lightning2 Single Fiber FFLX Coupler

**Manufacturer Part Number:**  
FLTNG2-01-SFC

▶ [Click here for more details on the AFL FOCIS Lightning2 Single Fiber FFLX Coupler](#)

### Last Image

Pressing the Last Image icon will display the most recently viewed image.

### Help Menu

This menu provides help tips regarding User Interface icons and functionality.

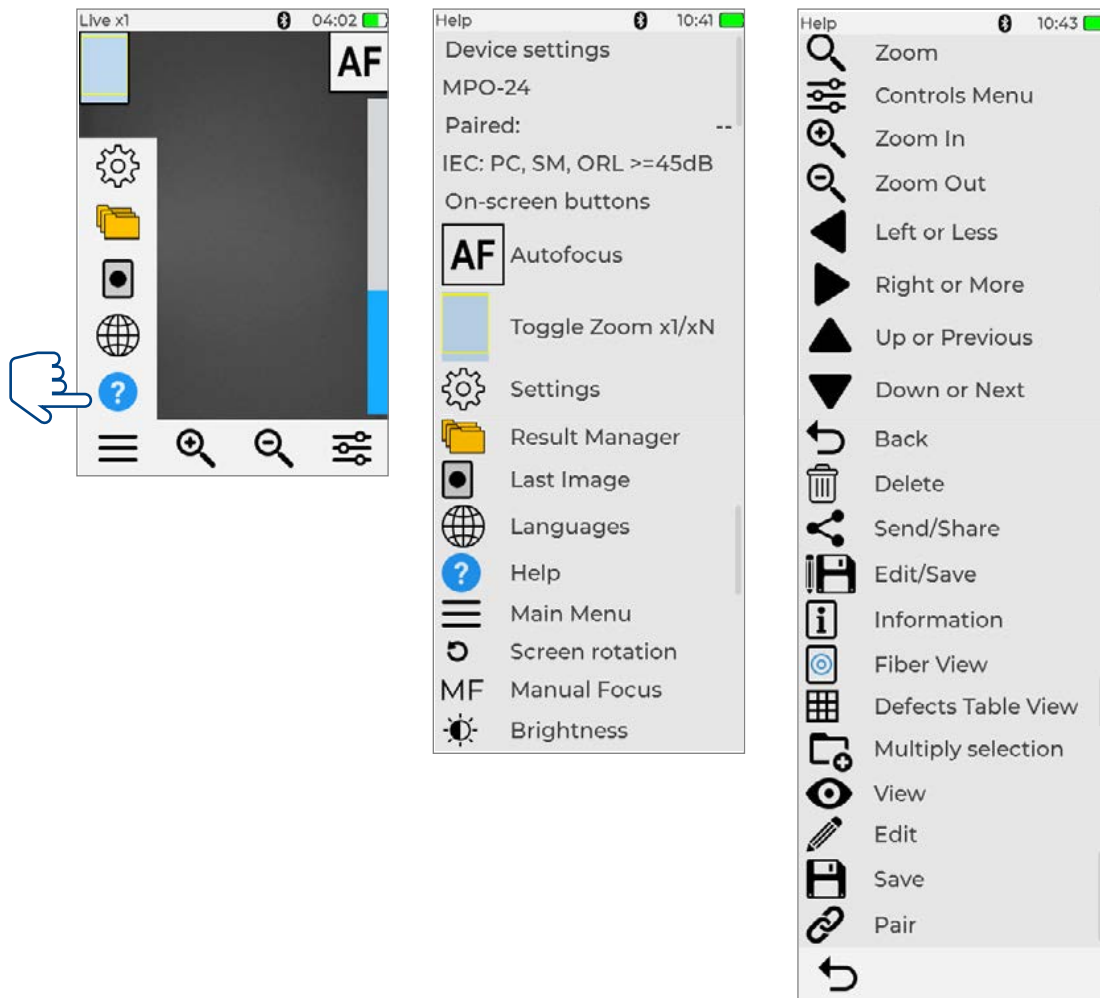

**Contact the professionals at Fiber Optic Center for a quote or to get more details.**



**Manufacturer:**  
AFL

**Product Name:**  
AFL FOCIS Lightning2 Single Fiber FFLX Coupler

**Manufacturer Part Number:**  
FLTNG2-01-SFC

▶ [Click here for more details on the AFL FOCIS Lightning2 Single Fiber FFLX Coupler](#)

### Managing Inspection Results

After image is captured FOCIS Lightning2 displays inspection results that may be saved on the unit internally.

#### Saving Results Manually

##### Creating New Folder & Saving Results to a Newly Created Folder

New Job/Scope End/Far End/Cable/Connector names/numbers are created by editing existing file name details.

1. While in the Captured Image screen, touch Menu, then touch Floppy to display Job Details screen.
2. On the Job Details screen, touch Job to edit name — this will create a new folder.
3. Touch /Scope End/Far End/Cable/Pair Mode/Pair Type/Connector to edit as needed.
4. Touch Floppy to save results to the newly created Job/Folder.
5. Display will show saving in progress and then reverts back to the Captured Image screen. Note that screen header changes from 'Captured @ hh:mm:ss' to 'COO1-00003'.

**Note:** The newly created Job/Folder becomes current where all subsequent test results will be saved.

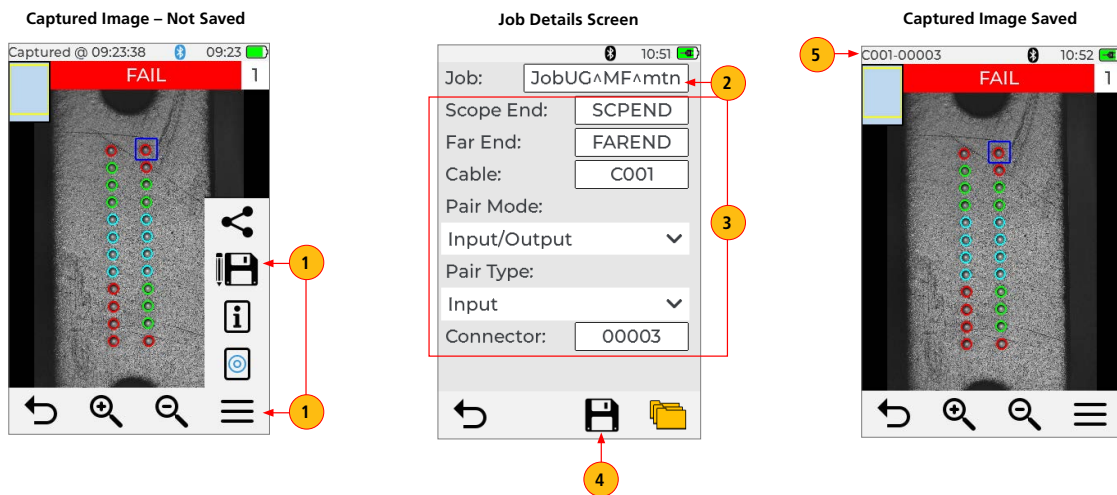

**Contact the professionals at Fiber Optic Center for a quote or to get more details.**





**Manufacturer:**  
AFL

**Product Name:**  
AFL FOCIS Lightning2 Single Fiber FFLX Coupler

**Manufacturer Part Number:**  
FLTNG2-01-SFC



▶ [Click here for more details on the AFL FOCIS Lightning2 Single Fiber FFLX Coupler](#)

#### Saving Results to the Current Folder

After image is captured FOCIS Lightning2 displays inspection results that may be saved on the unit internally.

1. While in the Captured Image screen, touch Menu, then touch Floppy to display Job Details screen.
  2. On the Job Details screen, verify that Job name and other details are correct.
  3. Touch Floppy button to save captured image and results to the current folder.
  4. Display will show saving in progress and then reverts back to the Captured Image screen.
- Note that screen header changes from 'Captured @ hh:mm:ss' to 'COO1-00003'.

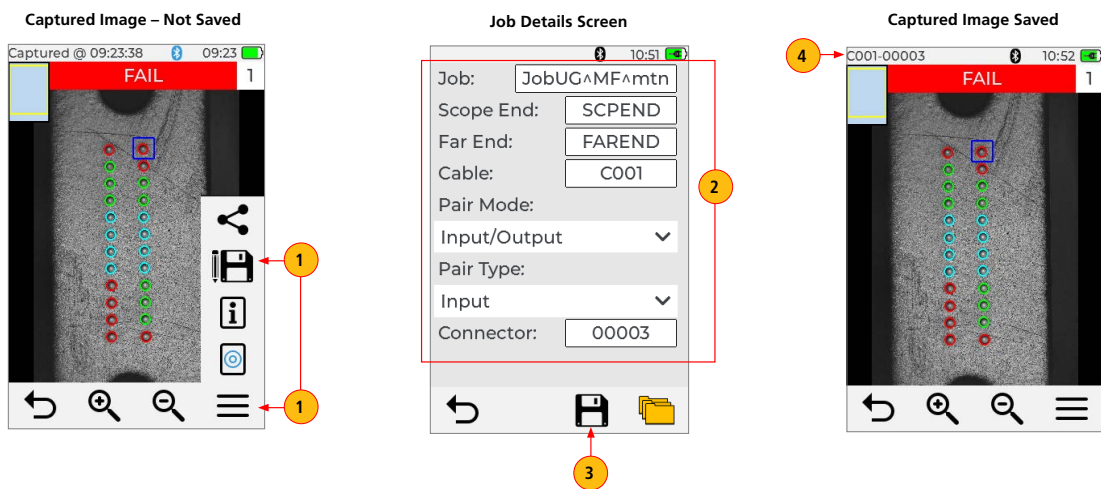

**Contact the professionals at Fiber Optic Center for a quote or to get more details.**

[focenter.com](http://focenter.com) • 508-992-6464 | (800) 473-4237 • [sales@focenter.com](mailto:sales@focenter.com)

23 Centre Street • New Bedford, MA 02740 USA



**Manufacturer:**  
AFL

**Product Name:**  
AFL FOCIS Lightning2 Single Fiber FFLX Coupler

**Manufacturer Part Number:**  
FLTNG2-01-SFC



▶ [Click here for more details on the AFL FOCIS Lightning2 Single Fiber FFLX Coupler](#)

**Saving to an Existing Folder, which is not Current**

1. While in the Captured Image screen, touch Menu, then touch Floppy to display Job Details screen.
2. On the Job Details screen, touch Folders icon to display Jobs screen.
3. Select the desired folder from the displayed list; touch OK.
4. Now, you are in the Cables screen. Select the desired cable from the displayed list; touch OK again.
5. When back in Job Details screen, verify that selected Job folder is displayed, then touch Floppy to save results in the selected folder.
6. Display will show saving in progress and then reverts back to the Captured Image screen.
7. Note that screen header changes from 'Captured @ hh:mm:ss' to 'COO1-00003'.

Captured Image – Not Saved

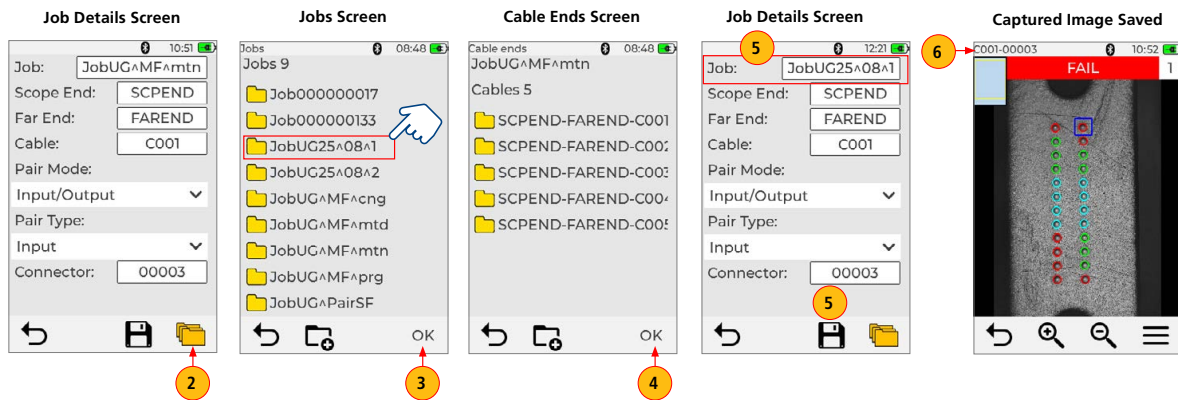
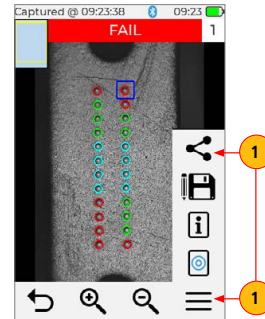

**Contact the professionals at Fiber Optic Center for a quote or to get more details.**

[focenter.com](http://focenter.com) • 508-992-6464 | (800) 473-4237 • [sales@focenter.com](mailto:sales@focenter.com)  
23 Centre Street • New Bedford, MA 02740 USA



**Manufacturer:**  
AFL  
**Product Name:**  
AFL FOCIS Lightning2 Single Fiber FFLX Coupler  
**Manufacturer Part Number:**  
FLTNG2-01-SFC

▶ Click here for more details on the AFL FOCIS Lightning2 Single Fiber FFLX Coupler

**Using Auto-Save Functionality to Save Captured Results Automatically**

Captured inspection results may be saved to FOCIS Lightning2 internally using 'Auto-Save' functionality.

1. Display Menu, then Touch Settings.
2. Touch Capture to display the Capture settings.
3. Enable Auto-Save functionality.
  - Touch Auto-Save drop-down menu.
  - Select on of the following:
    - Enable on 1st Capture, or
    - Enable on 2nd Capture.
4. When Auto-Save functionality is enabled, press the Capture button from the Live Image mode to auto-focus (if enabled), capture image, analyze pass/fail (if enabled), then save image and pass/fail results to configured Folder/File destination.

**Note:** If 'Auto-Save on 2nd Capture Key' is enabled, you will be prompted to press the Capture button again to save. Press the Back button if you do not wish to save or send image.

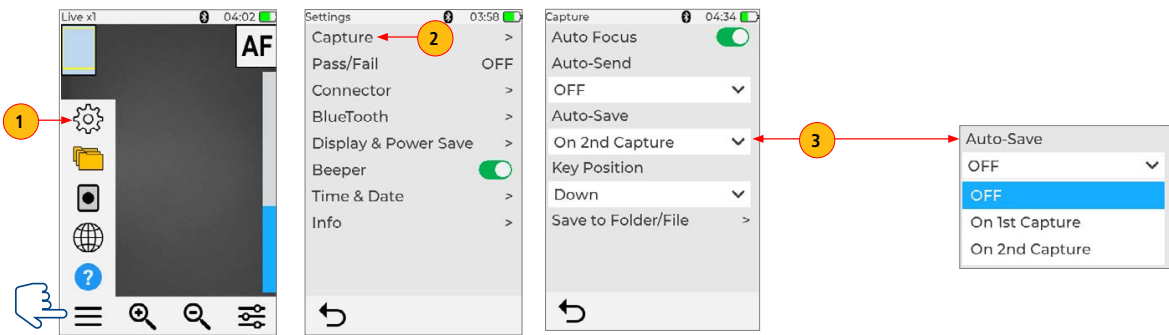

**Contact the professionals at Fiber Optic Center for a quote or to get more details.**



**Manufacturer:**  
AFL

**Product Name:**  
AFL FOCIS Lightning2 Single Fiber FFLX Coupler

**Manufacturer Part Number:**  
FLTNG2-01-SFC



▶ [Click here for more details on the AFL FOCIS Lightning2 Single Fiber FFLX Coupler](#)

### File Manager Functions

#### Opening Saved Image Files for Review

1. The Results Manager is accessed from the Main Menu:
  - From the Live Image screen, touch Menu, then touch Folders.
  - From the Captured Image screen, touch Menu, then touch Floppy, then, on the Job Details Screen, touch Folders.
2. On Jobs screen, Touch the desired Job folder, then touch OK to open.
3. On cable ends screen, touch the desired Cable folder, then touch OK to open.
4. On Results Files screen, touch the desired image file, then touch OK to open.

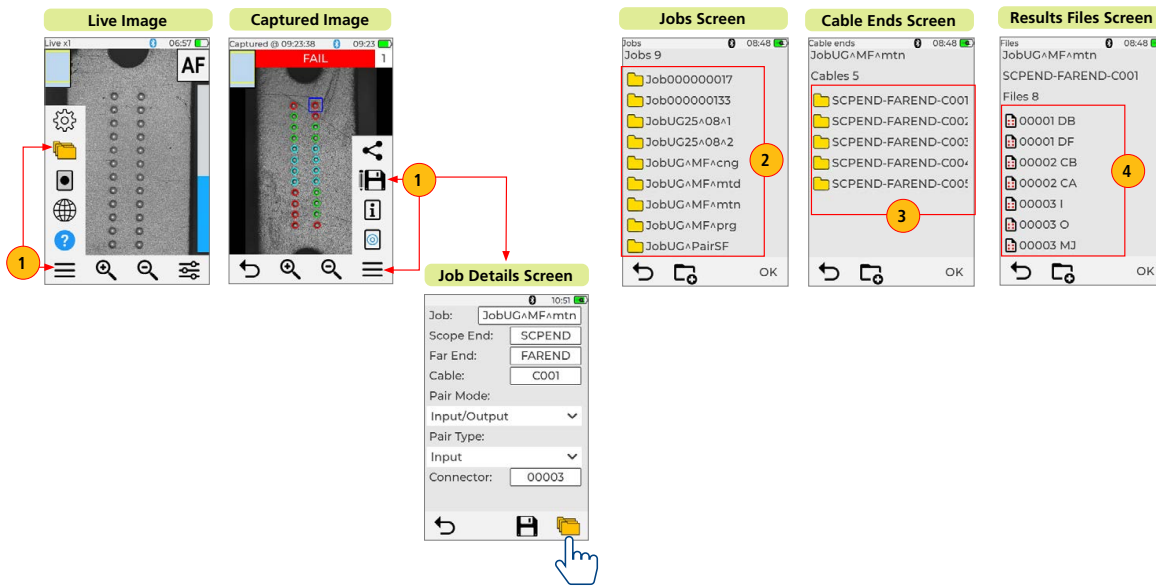

**Contact the professionals at Fiber Optic Center for a quote or to get more details.**

[focenter.com](http://focenter.com) • 508-992-6464 | (800) 473-4237 • [sales@focenter.com](mailto:sales@focenter.com)

23 Centre Street • New Bedford, MA 02740 USA



**Manufacturer:**  
AFL

**Product Name:**  
AFL FOCIS Lightning2 Single Fiber FFLX Coupler

**Manufacturer Part Number:**  
FLTNG2-01-SFC



▶ [Click here for more details on the AFL FOCIS Lightning2 Single Fiber FFLX Coupler](#)

**Creating New Jobs/Cables/Files**

New Job, Cable End, Cable, or Fiber names are created in the Captured Image mode by editing an existing file name. For details see section titled [“Creating New Folder & Saving Results to a Newly Created Folder”](#), page 32.

**Deleting Jobs/Cables/Files**

1. The Results Manager is accessed from the Main Menu:
  - From the Live Image screen, touch Menu, then touch Folders.
  - From the Captured Image screen, touch Menu, then touch Floppy, then, on the Job Details Screen, touch Folders.
2. On the Jobs/Cable Ends/ Files screen, touch Select button (presented by 'Folder+' icon).
3. Touch the desired Jobs/Cables/ Files to select them for deletion.
4. Touch Delete button (presented by 'Trash can' icon), then confirm deletion.

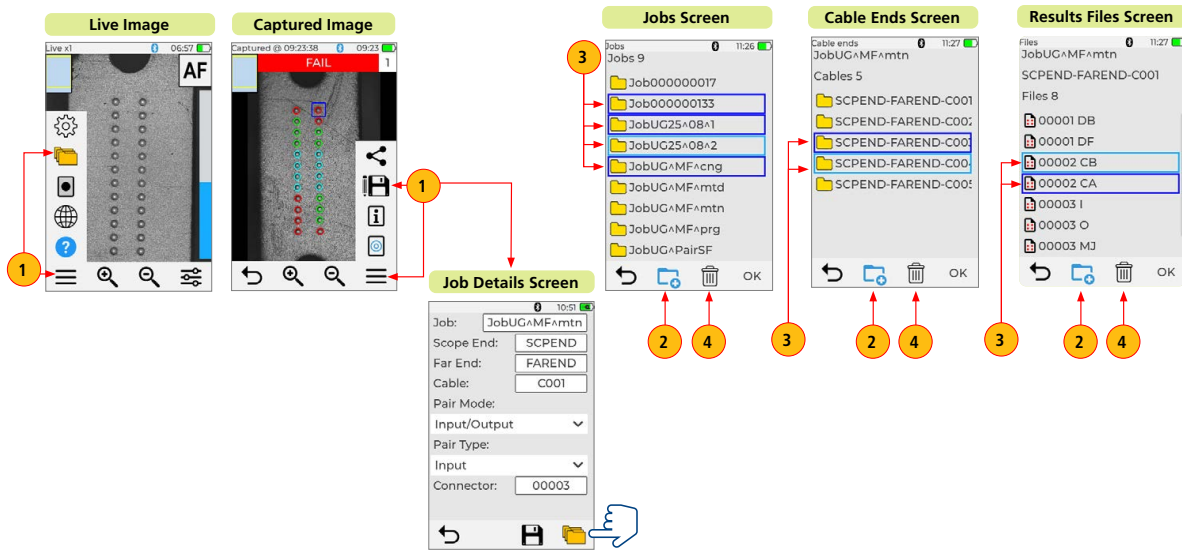

**Contact the professionals at Fiber Optic Center for a quote or to get more details.**



**Manufacturer:**  
AFL

**Product Name:**  
AFL FOCIS Lightning2 Single Fiber FFLX Coupler

**Manufacturer Part Number:**  
FLTNG2-01-SFC



▶ [Click here for more details on the AFL FOCIS Lightning2 Single Fiber FFLX Coupler](#)

### Sharing Inspection Results

#### Transferring Results Wirelessly via FlexApp to FlexReports

Use the FlexApp to wirelessly transfer test results to FlexReports PC-based software to make report generation quick and easy.

1. From the AFL test equipment (FlexScan or FOCIS), locate and select test results that you'd like to transfer.
2. Use FlexApp:
  - From Google Play or App Store, download FlexScan App to your mobile device.
  - Using FlexScan / FOCIS Bluetooth functionality, initiate transferring the selected test results to FlexApp.
  - Observe how FlexApp forwards test result files to FlexReporter cloud.
3. Use FlexReports to download test results from FlexReports cloud and create your test reports.

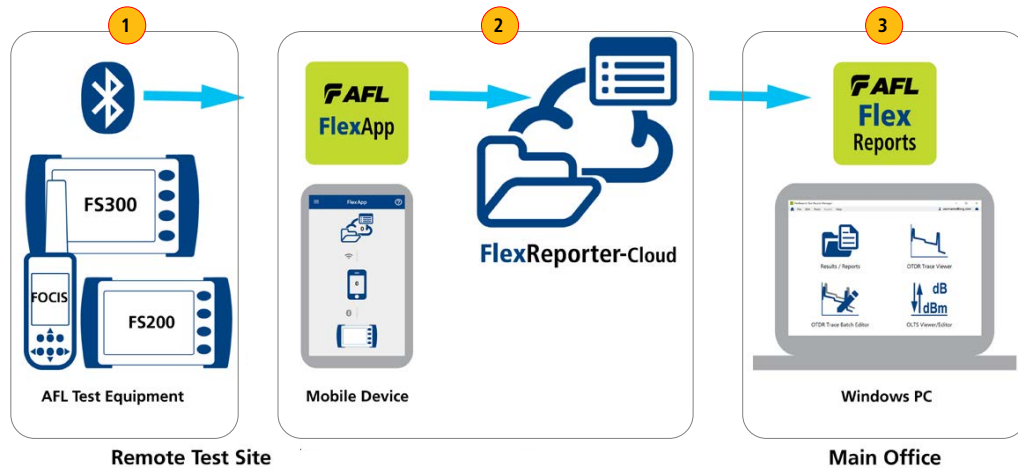

**Contact the professionals at Fiber Optic Center for a quote or to get more details.**

[focenter.com](http://focenter.com) • 508-992-6464 | (800) 473-4237 • [sales@focenter.com](mailto:sales@focenter.com)

23 Centre Street • New Bedford, MA 02740 USA

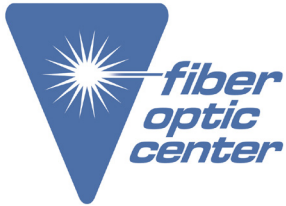

**Manufacturer:**  
AFL

**Product Name:**  
AFL FOCIS Lightning2 Single Fiber FFLX Coupler

**Manufacturer Part Number:**  
FLTNG2-01-SFC

 [Click here for more details on the AFL FOCIS Lightning2 Single Fiber FFLX Coupler](#)

**To install FlexApp on Android device**

- Go to Google Play.
- AFL's FlexApp is a free download.
- Install FlexApp to your device.

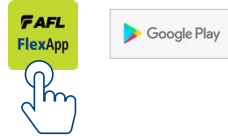

**To install FlexApp on iOS device**

- Go to Apple App Store.
- AFL's FlexApp is a free download.
- Install FlexApp to your device.



**Enable Bluetooth on your Mobile Device**

In your mobile device General Settings, make sure to enable Bluetooth and make your mobile device visible to other Bluetooth devices in range.

**Enable Bluetooth on Android device**

In your mobile device Bluetooth Settings:

- Enable Bluetooth.
- Make your device visible.

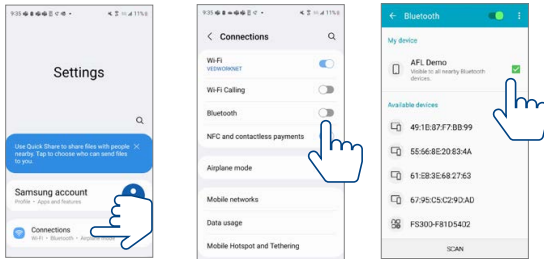

From Settings, go to Bluetooth

Enable Bluetooth

Make your mobile device visible

**Enable Bluetooth on iOS device**

In your mobile device Bluetooth Settings:

- Enable Bluetooth.
- Make your device visible.

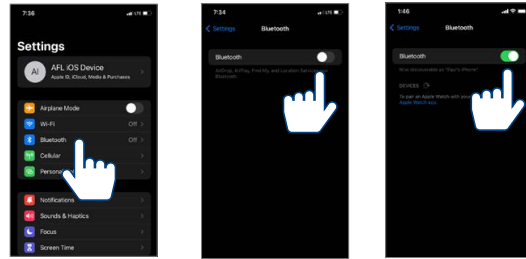

From Settings, go to Bluetooth

Enable Bluetooth

Make your mobile device visible

**Contact the professionals at Fiber Optic Center for a quote or to get more details.**



**Manufacturer:**  
AFL

**Product Name:**  
AFL FOCIS Lightning2 Single Fiber FFLX Coupler

**Manufacturer Part Number:**  
FLTNG2-01-SFC

▶ [Click here for more details on the AFL FOCIS Lightning2 Single Fiber FFLX Coupler](#)

**Pair FOCIS Lightning2 to your Mobile Device**

1. In the Live Image screen, touch Menu, then touch Settings.
2. In the Settings screen, touch Bluetooth.
3. Touch the Search icon to see all Bluetooth enabled devices in range.
4. When a list of visible devices is shown, touch the device to pair with.
5. Touch the Link icon to initiate pairing.
6. Confirm pairing on FOCIS Lightning2.
7. Confirm pairing on your mobile device.
8. Verify that FOCIS Lightning2 indicates that it is paired with your mobile device.

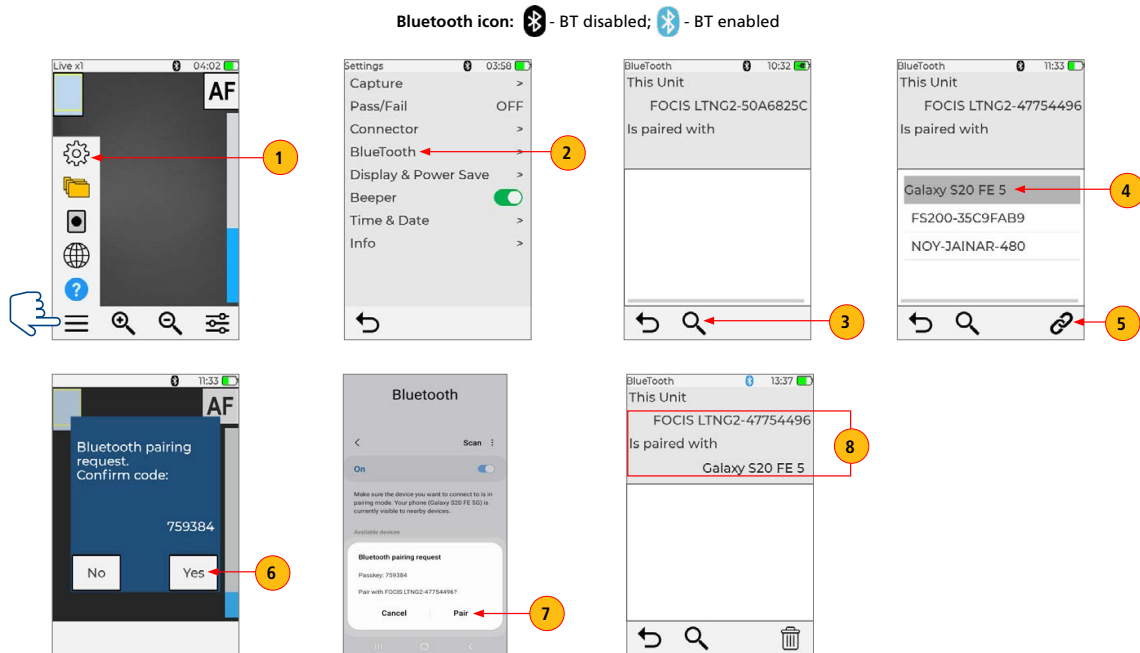

**Contact the professionals at Fiber Optic Center for a quote or to get more details.**





**Manufacturer:**  
AFL

**Product Name:**  
AFL FOCIS Lightning2 Single Fiber FFLX Coupler

**Manufacturer Part Number:**  
FLTNG2-01-SFC



▶ [Click here for more details on the AFL FOCIS Lightning2 Single Fiber FFLX Coupler](#)

#### Auto-send Inspection Results to FlexApp

Configure FOCIS Lightning2 to Send Results to Paired Mobile Device

1. In the Live Image screen, touch Menu, then touch Settings.
2. In the Settings screen, touch Capture.
3. In Capture Settings, configure to send inspection results to a paired device on 1st or 2nd Capture Key press.

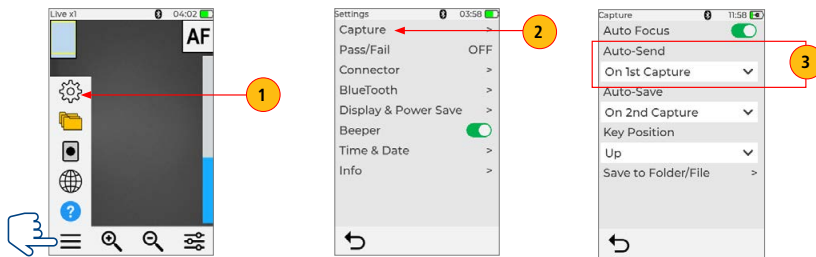

#### Auto-Send Results to Paired Mobile Device

4. Return to the Live Image mode, view connector end-face and press the Capture Key.
5. FOCIS Lightning2 will capture image and auto-send it to your mobile device. Hourglass will indicate progress.
6. When transfer complete, FOCIS Lightning2 indicates "Done". FlexApp on your mobile device will display the received image. See next section for details.

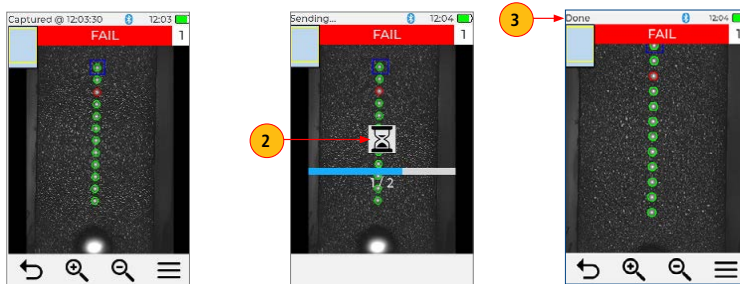

The sequence above shows the successful transfer of the captured image to the FlexApp

**Contact the professionals at Fiber Optic Center for a quote or to get more details.**

[focenter.com](http://focenter.com) • 508-992-6464 | (800) 473-4237 • [sales@focenter.com](mailto:sales@focenter.com)

23 Centre Street • New Bedford, MA 02740 USA

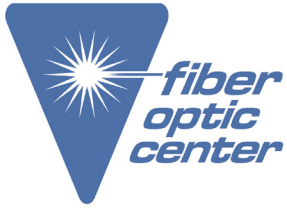

**Manufacturer:**  
AFL

**Product Name:**  
AFL FOCIS Lightning2 Single Fiber FFLX Coupler

**Manufacturer Part Number:**  
FLTNG2-01-SFC



▶ [Click here for more details on the AFL FOCIS Lightning2 Single Fiber FFLX Coupler](#)

**Receive Data on your Mobile Device with FlexApp**

1. In FlexApp, navigate to the Main Menu > Configure Inspection Naming menu.
2. Set Up inspection results naming; then touch Save.
3. Note that inspection results are transferred from the FOCIS Lightning2 to the FlexApp on your mobile device.
4. Tap on the Phone icon to navigate to transferred results.
5. Tap on the desired result file to display inspection image and data.
6. View inspection results.

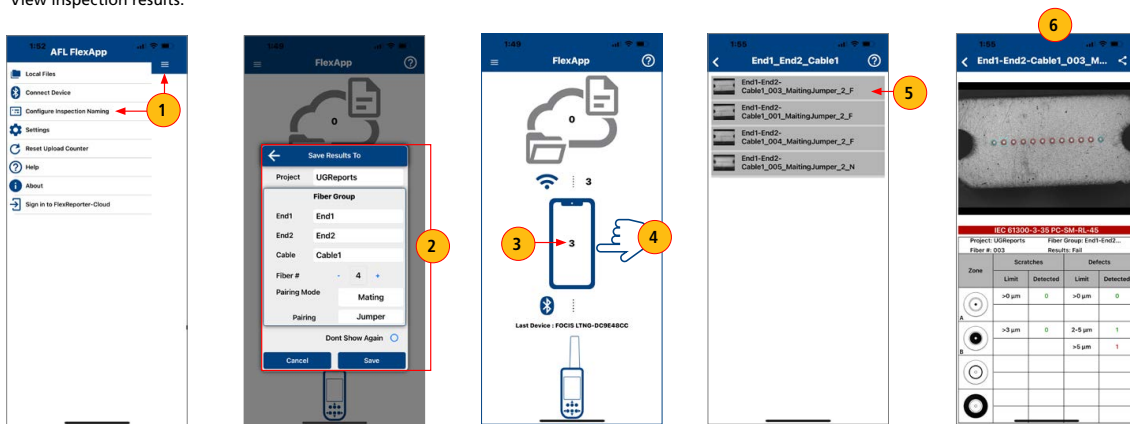

**Contact the professionals at Fiber Optic Center for a quote or to get more details.**

[focenter.com](http://focenter.com) • 508-992-6464 | (800) 473-4237 • [sales@focenter.com](mailto:sales@focenter.com)

23 Centre Street • New Bedford, MA 02740 USA



**Manufacturer:**  
AFL

**Product Name:**  
AFL FOCIS Lightning2 Single Fiber FFLX Coupler

**Manufacturer Part Number:**  
FLTNG2-01-SFC

▶ [Click here for more details on the AFL FOCIS Lightning2 Single Fiber FFLX Coupler](#)

**Manually Send Inspection Results to FlexApp**

1. Pair FOCIS Lightning2 to your Mobile Device. See ["Pair FOCIS Lightning2 to your Mobile Device"](#), page 40.
2. Press the Capture button to focus, capture and analyze image or recall saved image. See ["Opening Saved Image Files for Review"](#), page 36.
3. While in the Captured Image screen, touch Menu, then touch Share.
4. Hourglass will indicate the transfer progress.
5. When transfer complete, FOCIS Lightning2 indicates "Done".

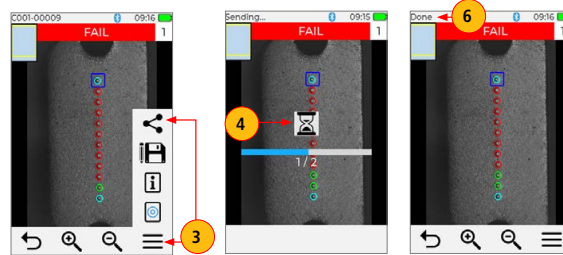

**Continue to FlexApp on your mobile device**

6. In FlexApp, navigate to the Main Menu > Configure Inspection Naming.
7. Set Up inspection results naming; then touch Save.
8. Note that inspection results are transferred from the FOCIS Lightning2 to the FlexApp on your mobile device.
9. Tap on the Phone icon to navigate to transferred results.
10. Tap on the desired result file to display inspection image and data.
11. View inspection results on your mobile device.

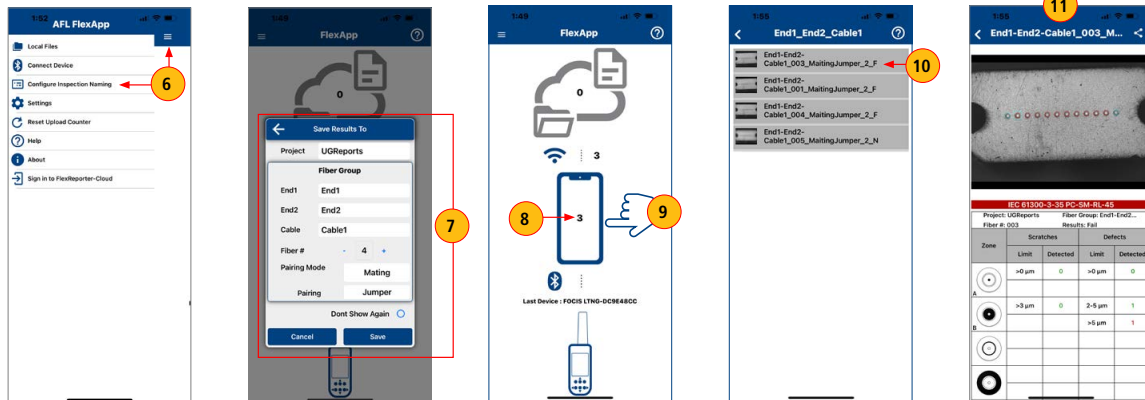

**Contact the professionals at Fiber Optic Center for a quote or to get more details.**



**Manufacturer:**

AFL

**Product Name:**

AFL FOCIS Lightning2 Single Fiber FFLX Coupler

**Manufacturer Part Number:**

FLTNG2-01-SFC



▶ [Click here for more details on the AFL FOCIS Lightning2 Single Fiber FFLX Coupler](#)

**Sending Captured Results to FlexScan**

**Automatically Send Captured Inspection Results to FlexScan**

Captured test results can be automatically sent to a Bluetooth paired FlexScan using Auto-Send functionality. Perform the following steps to pair your FOCIS Lightning2 to your FlexScan.

**On FlexScan**

1. Configure Bluetooth for pairing:
  - Select Settings > Bluetooth.
  - Enable Bluetooth with Visibility option setting them to 'On'.

**On FOCIS Lightning2**

2. Enable Bluetooth and pair your FOCIS Lightning2 to your FlexScan device. See [“Enabling Bluetooth and Pairing to another Bluetooth device”, page 28](#)
3. Configure FOCIS Lightning to auto-send captured images on 1st or 2nd Capture Key. See [“To Configure Auto-Send”, page 22](#)
4. Press the Capture button to return to Live Image mode.
5. Press the Capture button to focus, capture, analyze and send image to a paired FlexScan.

**Return to FlexScan**

6. After a few seconds, captured image and pass/fail results will appear on your FlexScan.

**Manually Send Captured Inspection Results to FlexScan**

1. Enable Bluetooth and pair your FOCIS Lightning2 to your FlexScan device. See [“Enabling Bluetooth and Pairing to another Bluetooth device”, page 28](#)
2. Press the Capture button to focus, capture and analyze image. Or recall saved image that you'd like to send.
3. Touch Menu, then touch Share.
4. After a few seconds, captured image will appear on the paired FlexScan.

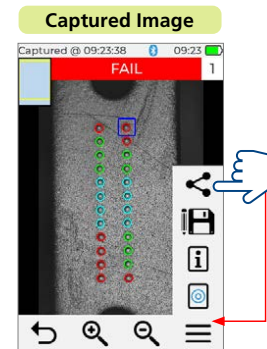

**Contact the professionals at Fiber Optic Center for a quote or to get more details.**

[focenter.com](http://focenter.com) • 508-992-6464 | (800) 473-4237 • [sales@focenter.com](mailto:sales@focenter.com)

23 Centre Street • New Bedford, MA 02740 USA



**Manufacturer:**  
AFL

**Product Name:**  
AFL FOCIS Lightning2 Single Fiber FFLX Coupler

**Manufacturer Part Number:**  
FLTNG2-01-SFC



▶ [Click here for more details on the AFL FOCIS Lightning2 Single Fiber FFLX Coupler](#)

### Uploading Inspection Results to FlexReporter

1. Connect FOCIS Lightning2 to PC using supplied USB to USB-C cable.
2. Turn on FOCIS Lightning2 and Select Mass Storage.
3. At PC, double-click on My Computer and verify that PROBE2 (D:) is displayed. (Probe's drive letter may be different)
4. Open RESULTS folder in PROBE2 (D:) to view saved Job folders.
5. Drag desired folders or files to the desired PC location

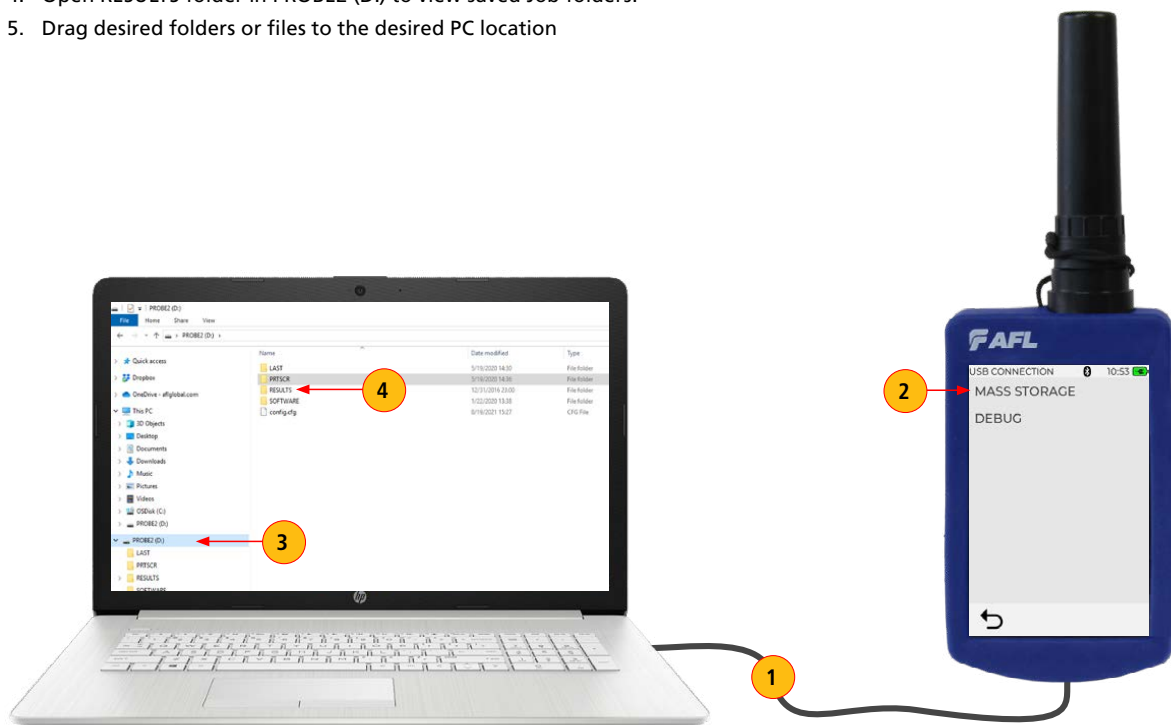

**Contact the professionals at Fiber Optic Center for a quote or to get more details.**

[focenter.com](http://focenter.com) • 508-992-6464 | (800) 473-4237 • [sales@focenter.com](mailto:sales@focenter.com)

23 Centre Street • New Bedford, MA 02740 USA



**Manufacturer:**  
AFL

**Product Name:**  
AFL FOCIS Lightning2 Single Fiber FFLX Coupler

**Manufacturer Part Number:**  
FLTNG2-01-SFC



▶ [Click here for more details on the AFL FOCIS Lightning2 Single Fiber FFLX Coupler](#)

### Generating Reports with FlexReporter Software Suite

**FlexReporter Software Suite** works with AFL Test and Inspection instruments to provide a simple-to-use, high performance cloud enabled reporting platform. FlexReporter combines FlexApp – a mobile App that wirelessly transfer test results to FlexReporter-Cloud from the field with a fast, comprehensive, 3-step reporting solution – FlexReports PC software. The FlexReporter software suite was developed to make the complicated task of reporting faster, simpler, and easy-to-use.

**FlexReports** is a Windows®-compatible PC software that provides comprehensive test results analysis and reporting for AFL FlexScan OTDRs, FOCIS inspection systems, OLTS, and OPM products.

**FlexApp** is a mobile Android and iOS App that supports AFL's FlexScan® OTDRs and FOCIS connector inspection products (FOCIS Flex, FOCIS Lightning). FlexApp wirelessly transfers test results from any FlexScan OTDR or FOCIS inspection probe directly to FlexReporter-Cloud from the field for subsequent analysis, editing, and reports generation with FlexReports PC software.

### Using FlexReports for Downloading Test Results from FlexReporter-Cloud

1. Install and run latest version of FlexReporter.
2. From FlexReports Home screen menu, click File and click "Log in to FlexReporter-Cloud" to log in.
3. Click "Download data from FlexReporter-Cloud". Navigate and select the desired folder with results for download, then click "Download".
4. Return to the FlexReports Home Menu to view results or generate a test report.

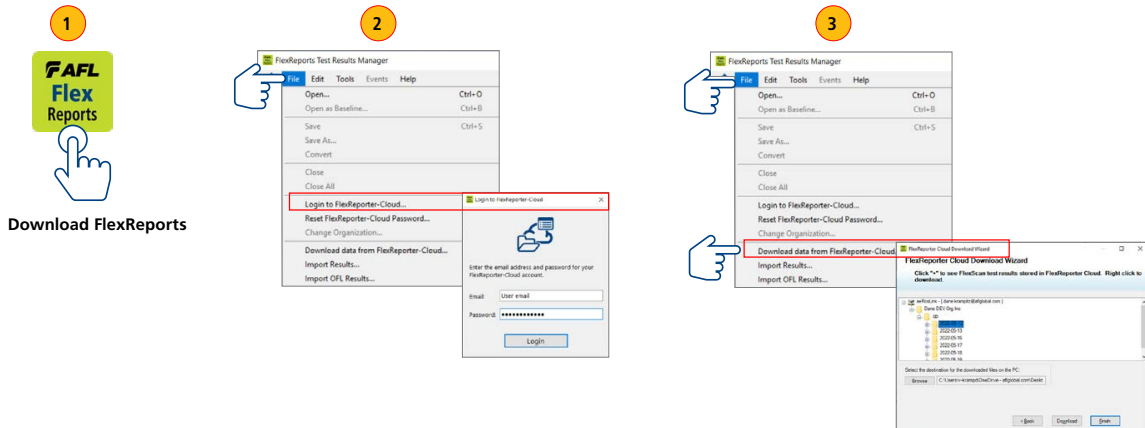

**Contact the professionals at Fiber Optic Center for a quote or to get more details.**

[focenter.com](http://focenter.com) • 508-992-6464 | (800) 473-4237 • [sales@focenter.com](mailto:sales@focenter.com)

23 Centre Street • New Bedford, MA 02740 USA

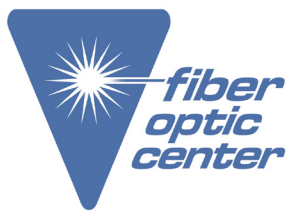

**Manufacturer:**  
AFL

**Product Name:**  
AFL FOCIS Lightning2 Single Fiber FFLX Coupler

**Manufacturer Part Number:**  
FLTNG2-01-SFC

▶ [Click here for more details on the AFL FOCIS Lightning2 Single Fiber FFLX Coupler](#)

**Creating MPD Inspection-only Reports**

1. From the FlexReports Home screen, select Results / Reports application
2. Navigate to uploaded FOCIS Lightning2 results.
  - Select Route folder(s) for all results.
  - Select Cable for cable results.
  - Select individual MPO(s) for connector results
3. Access Report Wizard by clicking the Report Wizard button.
4. Follow the on-screen instructions for generating, saving, and printing test reports.
  - Select desired inspection template (2 or 12 results per page).
  - Select Finish and print or save as PDF.

See FlexReports User's Guide

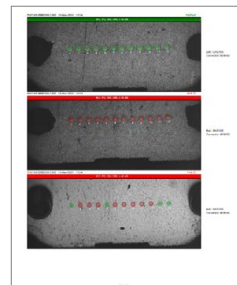
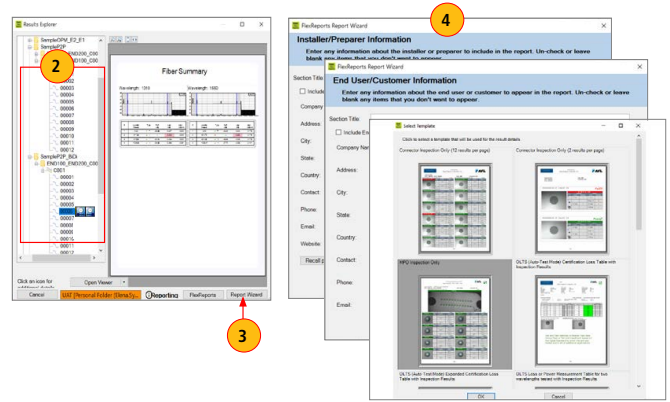
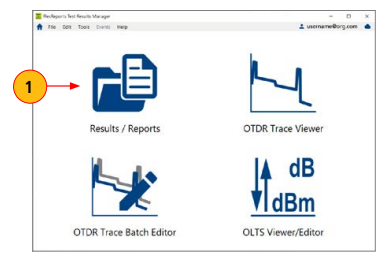

MPO Cable Summary Report

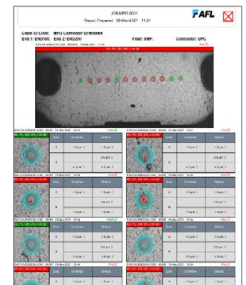

MPO Inspection Detail Report

**Contact the professionals at Fiber Optic Center for a quote or to get more details.**