

# QUICK START GUIDE



**Manufacturer:**  
Dymax

**Product Name:**  
Dymax 5000-EC UV Curing Flood Lamp with Mounting Stand

**Manufacturer Part Number:**  
39830

▶ [Click here for more details on the Dymax 5000-EC UV Curing Flood Lamp with Mounting Stand](#)

Click the thumbnail below to navigate to the Quick Start Guide



[EC Series Flood Lamps with Light Shield Quick Start Guide](#)



[EC Series Flood Lamps with Light Shield & Manual Shutter Quick Start Guide](#)



[EC Light Shield Door Interlock Quick Start Guide](#)

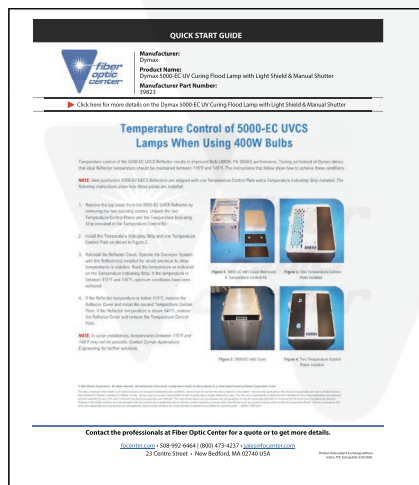

[Temperature Control of 5000-EC UVCS Lamps Quick Start Guide](#)

**Contact the professionals at Fiber Optic Center for a quote or to get more details.**

[focenter.com](http://focenter.com) • 508-992-6464 | (800) 473-4237 • [sales@focenter.com](mailto:sales@focenter.com)

23 Centre Street • New Bedford, MA 02740 USA

Product data subject to change without notice. FOC last update 3/23/2026.

# QUICK START GUIDE



**Manufacturer:**

Dymax

**Product Name:**

Dymax 5000-EC UV Curing Flood Lamp with Mounting Stand

**Manufacturer Part Number:**

39830

▶ [Click here for more details on the Dymax 5000-EC UV Curing Flood Lamp with Mounting Stand](#)

## EC-Series Flood Lamps with Light Shield Assembly Instructions

1. Unpack the light shield (PN [41175](#)) and remove protective coverings.
2. Unpack the EC-series flood lamp. Install the bulb into the reflector housing ensuring that the bulb is properly seated. If desired, install the fan to the top of the reflector housing (the fan is available as an option).
3. Invert the reflector and remove the four screws (Figures 1-3).



Figure 1-3. Remove Screws

4. If using the 2000-EC Reflector, an optional glass filter is available. If desired, install the glass filter plate by removing the two support bars and four spacers from the 2000-EC reflector. Install the glass filter on the reflector and position the four spacers around the filter. Reinstall the two support bars.
5. Fasten the appropriate Support Plate to the Reflector with the four screws removed in step 1 (Figure 4-5).

**NOTE:** When using a 2000-EC lamp, position the Support Plate so that the side with cropped corners is facing the rear of the Reflector (side with four connections). The Reflector/Support Plate Assembly will not sit flush on the Light Shield if this plate is attached backwards.



Figure 4-5. Fasten the Appropriate Support Plate to the Reflector

[>> Return to Page 1](#)

Contact the professionals at Fiber Optic Center for a quote or to get more details.

[focenter.com](http://focenter.com) • 508-992-6464 | (800) 473-4237 • [sales@focenter.com](mailto:sales@focenter.com)

23 Centre Street • New Bedford, MA 02740 USA

Product data subject to change without notice. FOC last update 3/23/2026.

6. Remove the four M4 x 8-mm screws from the Light Shield's Top Cover (Figure 6).
7. Place the Reflector Assembly onto the Light Shield. Using the M4 x 8-mm screws, secure the Reflector/Support Plate Assembly to the Light Shield (Figure 7).

NOTE: Do not tighten until directed in Step 8.



Figure 6. Remove Screws from Light Shield Top Cover



Figure 7. Secure the Reflector/Support Plate Assembly to the Light Shield

8. Center the Reflector Assembly on the Light Shield. When the desired position is achieved, fully tighten the Securing Brackets to the Light Shield.
9. Install cable PN 40878 between the connector on the rear of the Light Shield and J5 on the back of the reflector (this cable is packaged with the Light Shield). Install the larger Cable (PN 37904) between J3 on the back of the Reflector and the back of the Power Supply. Install the Power Cable (PN 35255) to the back of the Power Supply (Figure 7).

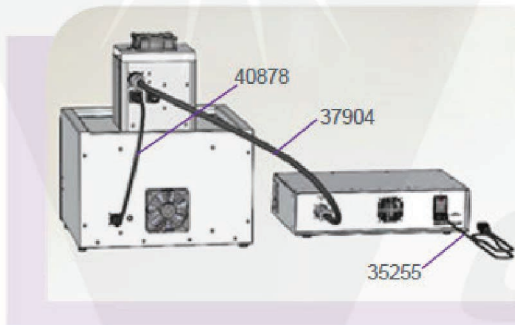

Figure 7. Rear Connections (5000-EC Shown)



Figure 8. Complete System (2000-EC Shown)

10. For your safety, always wear the proper protective equipment when working with UV light-curing systems. Once you are wearing the appropriate gear, turn the power supply's power switch on and allow bulb to warm-up for 5 minutes.
11. The flood lamp system is ready for operation.

**Please Refer to Component User Guides for Detailed Operating Instruction**

The data contained in this bulletin is of a general nature and is based on laboratory test conditions. Dymax does not assume responsibility for test or performance results obtained by users. It is the user's responsibility to determine the suitability for the product application and purposes and the suitability for use in the user's intended manufacturing apparatus and methods. The user should adopt such precautions and use guidelines as may be reasonably advisable or necessary for the protection of property and persons. Nothing in this bulletin shall act as a representation that the product use or application will not infringe a patent owned by someone other than Dymax or act as a grant of license under any Dymax Corporation Patent. Dymax recommends that each user adequately test its proposed use and application before actual repetitive use, using the data contained in this bulletin as a general guide. QS066 08/06/2021

>> Return to Page 1

**Contact the professionals at Fiber Optic Center for a quote or to get more details.**

[focenter.com](http://focenter.com) • 508-992-6464 | (800) 473-4237 • [sales@focenter.com](mailto:sales@focenter.com)

23 Centre Street • New Bedford, MA 02740 USA

Product data subject to change without notice. FOC last update 3/23/2026.

# QUICK START GUIDE



**Manufacturer:**

Dymax

**Product Name:**

Dymax 5000-EC UV Curing Flood Lamp with Mounting Stand

**Manufacturer Part Number:**

39830

▶ [Click here for more details on the Dymax 5000-EC UV Curing Flood Lamp with Mounting Stand](#)

## EC-Series Flood Lamps with Light Shield & Manual Shutter

1. Unpack the light shield (PN [41175](#)) and remove protective coverings.
2. Unpack the EC-series flood lamp. Install the bulb into the reflector housing ensuring that the bulb is properly seated. If desired, install the fan option to the top of the reflector housing (the fan is available as an option).
3. Unpack the manual shutter. The shutter is shipped with the 5000-EC reflector support plate installed. Remove the support plate by removing the four 8-32 x 3/8" screws (Figure 1).

*NOTE: This plate is not used when a 2000-EC is used.*

4. Unpack the power supply and reflector. Remove the four screws from the Reflector (Figure 2).

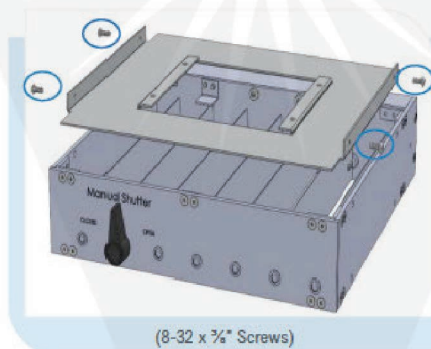

Figure 1. Remove 5000-EC Reflector Support Plate



Figure 2. Remove Screws from Reflector



5. If using the 2000-EC reflector, an optional glass filter is available. If desired, install the glass filter plate by removing the two support bars and four spacers from the 2000-EC reflector. Install the glass filter on the reflector and position the four spacers around the filter. Reinstall the two support bars.
6. Fasten the appropriate support plate(s) to the reflector with the four screws removed in step 5 (Figure 3).



2000-EC (6-32 x 1/2" Screws)



5000-EC (8-32 x 1/4" Screws)

[>> Return to Page 1](#)

Contact the professionals at Fiber Optic Center for a quote or to get more details.

[focenter.com](http://focenter.com) • 508-992-6464 | (800) 473-4237 • [sales@focenter.com](mailto:sales@focenter.com)

23 Centre Street • New Bedford, MA 02740 USA

Product data subject to change without notice. FOC last update 3/23/2026.

Figure 3. Install Support Plate

7. Place the reflector assembly into the shutter.
8. Remove the four M4 x 8-mm screws from the top of the Light Shield (Figure 4).
9. Place the shutter and reflector assembly into the top of the light shield. Align the holes on the shutter with the holes on the two securing brackets. Install the two securing brackets (Figure 5) using the 8-32 x 3/8" screws provided.

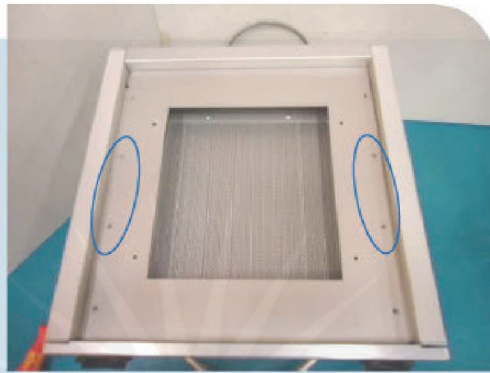

Figure 4. Remove Screws from Light Shield



Figure 5. Install Securing Brackets

10. Center the shutter on the light shield. When the desired position is achieved, tighten all fasteners.
11. Install cable PN 40878 between the connector on the rear of the light shield and the back of the reflector. Install the large cable between the back of the reflector and the back of the power supply (PN 37904). These cables are color coded to aid assembly. Install the power cable (PN 35255) to the rear of the power supply.
12. Your light shield, manual shutter, and lamp assembly is ready for operation. The shutter may be controlled by means of manual lever on the front of the shutter.

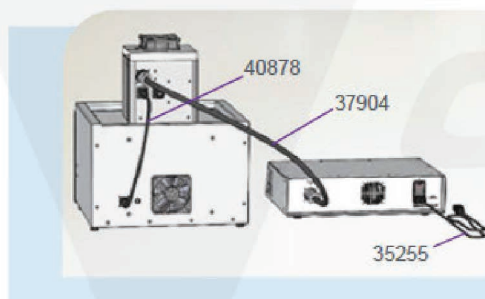

Figure 6. Complete System (5000-EC Shown)



Figure 7. Complete System (2000-EC Shown)

The data contained in this bulletin is of a general nature and is based on laboratory test conditions. Dymax does not assume responsibility for test or performance results obtained by users. It is the user's responsibility to determine the suitability for the product application and purposes and the suitability for use in the user's intended manufacturing apparatus and methods. The user should adopt such precautions and use guidelines as may be reasonably advisable or necessary for the protection of property and persons. Nothing in this bulletin shall act as a representation that the product use or application will not infringe a patent owned by someone other than Dymax or act as a grant of license under any Dymax Corporation Patent. Dymax recommends that each user adequately test its proposed use and application before actual repetitive use, using the data contained in this bulletin as a general guide. QS067 08/06/2021

>> Return to Page 1

**Contact the professionals at Fiber Optic Center for a quote or to get more details.**

[focenter.com](http://focenter.com) • 508-992-6464 | (800) 473-4237 • [sales@focenter.com](mailto:sales@focenter.com)

23 Centre Street • New Bedford, MA 02740 USA

Product data subject to change without notice. FOC last update 3/23/2026.

# QUICK START GUIDE



**Manufacturer:**

Dymax

**Product Name:**

Dymax 5000-EC UV Curing Flood Lamp with Mounting Stand

**Manufacturer Part Number:**

39830

▶ [Click here for more details on the Dymax 5000-EC UV Curing Flood Lamp with Mounting Stand](#)



## EC Light Shield (PN 41175) Door Interlock Installation Instructions

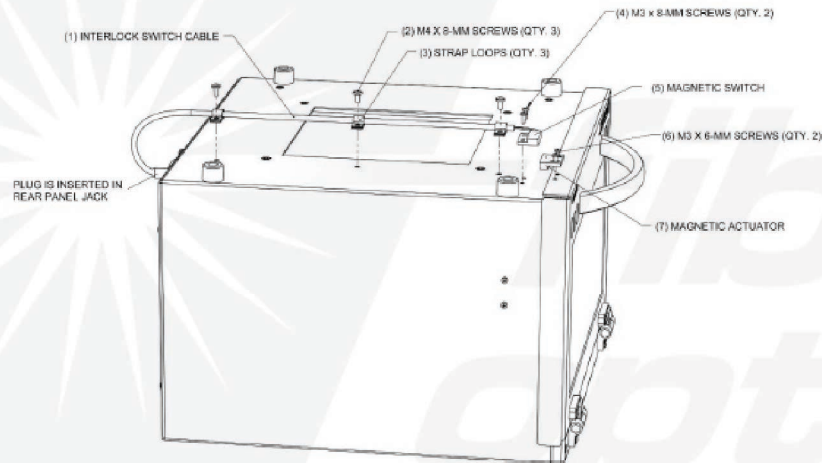

Figure 1. Light Shield (PN 41175) with Door Interlock Kit (PN 41166) (shown upside down)

1. Turn off the power and remove all cables from the Light Shield.
2. Remove the Reflector and Shutter from the top of the Light Shield. Place the Light Shield on its side.
3. Remove the five screws from the bottom of the Light Shield (Figure 2).
4. Attach the Magnetic Switch to the bottom of the housing using two M3 x 8-mm screws (Figure 3).

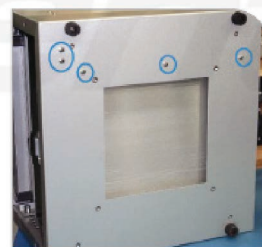

Figure 2. Remove Screws



Figure 3. Magnetic Switch

>> [Return to Page 1](#)

Contact the professionals at Fiber Optic Center for a quote or to get more details.

[focenter.com](http://focenter.com) • 508-992-6464 | (800) 473-4237 • [sales@focenter.com](mailto:sales@focenter.com)

23 Centre Street • New Bedford, MA 02740 USA

Product data subject to change without notice. FOC last update 3/23/2026.

5. Fasten the Interlock Switch Cable to the bottom side of the unit using the three Nylon Strap Loops and the three M4 x 8-mm screws (Figure 4).

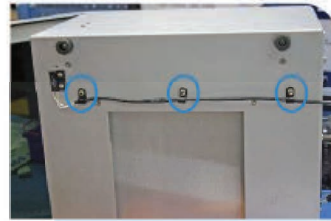

Figure 4. Interlock Switch Cable

6. Attach the Magnetic Actuator to the Front Door using the two M3 x 6-mm screws (Figure 5).

*Note: Check that the Magnetic Switch and the Magnetic Actuator are aligned.*



Figure 5. Install Magnetic Actuator

7. Plug the connector to the power jack at the back of the unit. (Figure 6)

8. Turn the unit back over to the working orientation and reinstall the Shutter and Reflector.



Figure 6. Connect Power Jack

© 2021 Dymax Corporation. All rights reserved. All trademarks in this guide, except where noted, are the property of, or used under license by Dymax Corporation, U.S.A.

The data contained in this bulletin is of a general nature and is based on laboratory test conditions. Dymax does not warrant the data contained in this bulletin. Any warranty applicable to the product, its application and use is strictly limited to that contained in Dymax's standard Conditions of Sale. Dymax does not assume responsibility for test or performance results obtained by users. It is the user's responsibility to determine the suitability for the product application and purposes and the suitability for use in the user's intended manufacturing apparatus and methods. The user should adopt such precautions and use guidelines as may be reasonably advisable or necessary for the protection of property and persons. Nothing in this bulletin shall act as a representation that the product use or application will not infringe a patent owned by someone other than Dymax or act as a grant of license under any Dymax Corporation Patent. Dymax recommends that each user adequately test its proposed use and application before actual repetitive use, using the data contained in this bulletin as a general guide. QSD69 08/06/2021

>> Return to Page 1

**Contact the professionals at Fiber Optic Center for a quote or to get more details.**

[focenter.com](http://focenter.com) • 508-992-6464 | (800) 473-4237 • [sales@focenter.com](mailto:sales@focenter.com)

23 Centre Street • New Bedford, MA 02740 USA

Product data subject to change without notice. FOC last update 3/23/2026.

# QUICK START GUIDE



**Manufacturer:**

Dymax

**Product Name:**

Dymax 5000-EC UV Curing Flood Lamp with Mounting Stand

**Manufacturer Part Number:**

39830

▶ [Click here for more details on the Dymax 5000-EC UV Curing Flood Lamp with Mounting Stand](#)

## Temperature Control of 5000-EC UVCS Lamps When Using 400W Bulbs

Temperature control of the 5000-EC UVCS Reflector results in improved Bulb (400W, PN 38560) performance. Testing performed at Dymax shows that ideal Reflector temperature should be maintained between 115°F and 145°F. The instructions that follow show how to achieve these conditions

**NOTE:** New production 5000-EC UVCS Reflectors are shipped with one Temperature Control Plate and a Temperature Indicating Strip installed. The following instructions show how these plates are installed.

1. Remove the top cover from the 5000-EC UVCS Reflector by removing the two securing screws. Unpack the two Temperature Control Plates and the Temperature Indicating Strip provided in the Temperature Control Kit.
2. Install the Temperature Indicating Strip and one Temperature Control Plate as shown in Figure 2.
3. Reinstall the Reflector Cover. Operate the Conveyor System with the Reflector(s) installed for about one hour to allow temperatures to stabilize. Read the temperature as indicated on the Temperature Indicating Strip. If the temperature is between 115°F and 145°F, optimum conditions have been achieved.
4. If the Reflector temperature is below 115°F, remove the Reflector Cover and install the second Temperature Control Plate. If the Reflector temperature is above 145°F, remove the Reflector Cover and remove the Temperature Control Plate.

**NOTE:** In some installations, temperatures between 115°F and 145°F may not be possible. Contact Dymax Applications Engineering for further solutions.



Figure 1. 5000-EC with Cover Removed & Temperature Control Kit



Figure 2. One Temperature Control Plate Installed



Figure 3. 5000-EC with Cover



Figure 4. Two Temperature Control Plates Installed

© 2021 Dymax Corporation. All rights reserved. All trademarks in this guide, except where noted, are the property of, or used under license by Dymax Corporation, U.S.A.

The data contained in this bulletin is of a general nature and is based on laboratory test conditions. Dymax does not warrant the data contained in this bulletin. Any warranty applicable to the product, its application and use is strictly limited to that contained in Dymax's standard Conditions of Sale. Dymax does not assume responsibility for test or performance results obtained by users. It is the user's responsibility to determine the suitability for the product application and purposes and the suitability for use in the user's intended manufacturing apparatus and methods. The user should adopt such precautions and use guidelines as may be reasonably advisable or necessary for the protection of property and persons. Nothing in this bulletin shall act as a representation that the product use or application will not infringe a patent owned by someone other than Dymax or act as a grant of license under any Dymax Corporation Patent. Dymax recommends that each user adequately test its proposed use and application before actual repetitive use, using the data contained in this bulletin as a general guide. QS001 10/07/2021

>> [Return to Page 1](#)

**Contact the professionals at Fiber Optic Center for a quote or to get more details.**

[focenter.com](http://focenter.com) • 508-992-6464 | (800) 473-4237 • [sales@focenter.com](mailto:sales@focenter.com)

23 Centre Street • New Bedford, MA 02740 USA

Product data subject to change without notice. FOC last update 3/23/2026.