



**Manufacturer:**

Dymax

**Product Name:**

Dymax BlueWave® MX-150 LED Spot-Curing Emitter - 385nm

**Manufacturer Part Number:**

42337

▶ [Click here for more details on the Dymax BlueWave® MX-150 LED Spot-Curing Emitter - 385nm](#)

## BlueWave® MX-150 LED Spot-Curing System

### High-Intensity Curing System with the Flexibility of Multiple Systems

- LED chip located in the emitter, not the controller, for more consistent intensity
- Available with three wavelength emitters - 365, 385, & 405 nm
- One controller controls up to 4 emitters
- Controller has touchscreen interface with full keyboard
- Has the ability to save curing programs so they can be easily recalled
- PLC interface

The BlueWave® MX-150 curing system provides manufacturers with the curing flexibility they need, in a smaller, more efficient design. The unit is comprised of two main parts, a controller with an easy-to-use touchscreen interface and a high-intensity LED emitter. Curing energy is created using an LED chip in the emitter, unlike traditional spot-cure systems, where it is located in the controller. Locating the LED chip at the point-of-cure provides more consistent curing by addressing potential intensity loss caused by the use of long or bent lightguides. The controller can run up to four emitters independently.

The system can be truly tailored to users' curing needs – allowing them to choose from three different wavelength LED emitters (365, 385, or 405 nm) so optimal cures are achieved. Users also have endless set up flexibility; for automated curing processes, the emitter can be easily mounted to robotic arms or further from the controller without fear of intensity variations. When used as a bench-top curing system, the unit can be paired with a stand and shielding or a lightguide can be connected to the system for specialized applications.

**Contact the professionals at Fiber Optic Center for a quote or to get more details.**

[focenter.com](http://focenter.com) • 508-992-6464 | (800) 473-4237 • [sales@focenter.com](mailto:sales@focenter.com)

23 Centre Street • New Bedford, MA 02740 USA

*Product specifications and data are subject to change without notice.*



**Manufacturer:**

Dymax

**Product Name:**

Dymax BlueWave® MX-150 LED Spot-Curing Emitter - 385nm

**Manufacturer Part Number:**

42337

▶ [Click here for more details on the Dymax BlueWave® MX-150 LED Spot-Curing Emitter - 385nm](#)

## System Features & Benefits

Features	Benefits
High intensity of up to 40 W/cm <sup>2</sup>	<ul style="list-style-type: none"> <li>• Quickly cures a variety of materials.</li> </ul>
LED emitters available in 365, 385, or 405 nm wavelengths	<ul style="list-style-type: none"> <li>• Compatible with a variety of UV and visible light-curable materials</li> <li>• Wavelength flexibility allows co-optimization of adhesive and curing system for optimal cure</li> </ul>
LED chip located in the emitter, not the controller	<ul style="list-style-type: none"> <li>• Consistent intensity</li> <li>• Mounted emitter saves the cost of lightguides</li> <li>• Eliminates potential intensity loss from long or bent lightguides</li> <li>• Easily mounted to robotic arms with no intensity variation</li> <li>• Emitter can be mounted closer to application, while the controller remains close to the operator</li> </ul>
One controller runs up to four emitters	<ul style="list-style-type: none"> <li>• Reduces the number of controllers required</li> <li>• Emitters can be added to grow with your application</li> <li>• Each emitter can be controlled independently of the others with four separate work stations from a single controller</li> <li>• Reduces equipment footprint and cost.</li> </ul>
Admin and Production Modes	<ul style="list-style-type: none"> <li>• Production mode for simple on/off operation</li> <li>• Curing programs can be saved and easily recalled</li> <li>• Units can be password protected so only the production mode can be accessed by workers</li> </ul>
Touch screen with full keyboard	<ul style="list-style-type: none"> <li>• Improved user interface</li> <li>• Curing programs can be easily entered, stored, and recalled when needed</li> </ul>
Compatible with 3- and 5-mm lightguides with Wolf connector	<ul style="list-style-type: none"> <li>• Utilizes standard/readily available lightguides</li> </ul>
Instant on-off	<ul style="list-style-type: none"> <li>• No warm-up period</li> <li>• More energy efficient</li> </ul>
Efficient LED temperature management and system monitoring	<ul style="list-style-type: none"> <li>• Maximized continuous operation without overheating</li> <li>• Comfortable hand-held operating temperature</li> <li>• Temperature monitoring assures maximum LED life</li> <li>• Checks presence of lightguide or other delivery optic</li> </ul>
PLC interface	<ul style="list-style-type: none"> <li>• Easily incorporated into automated systems</li> </ul>

**Contact the professionals at Fiber Optic Center for a quote or to get more details.**

[focenter.com](http://focenter.com) • 508-992-6464 | (800) 473-4237 • [sales@focenter.com](mailto:sales@focenter.com)

23 Centre Street • New Bedford, MA 02740 USA

*Product specifications and data are subject to change without notice.*



**Manufacturer:**

Dymax

**Product Name:**

Dymax BlueWave® MX-150 LED Spot-Curing Emitter - 385nm

**Manufacturer Part Number:**

42337

▶ [Click here for more details on the Dymax BlueWave® MX-150 LED Spot-Curing Emitter - 385nm](#)

## Admin and Production Modes

Admin mode fully unlocks the device and allows for setting curing time and intensity cycles. Each individual curing cycle can be entered and saved as a program and recalled when needed. The production mode is designed for simple operation by manufacturing personnel. Settings and access to admin mode can be password protected using the full QWERTY keyboard.

## LED Light-Curing Technology

Dymax LED spot-curing systems generate curing energy using high-intensity LEDs instead of conventional metal-halide or mercury-arc lamps. The relatively narrow frequency band of energy emitted by LEDs results in cooler substrate temperatures compared to traditional UV-style lamp systems, making them ideal for curing thermally sensitive materials. Dymax LED-curing systems offer many energy and cost-saving benefits, such as no warm-up period, lower energy consumption, no bulbs to change, and more consistent frequency and intensity output for better process control.

**Contact the professionals at Fiber Optic Center for a quote or to get more details.**

[focenter.com](http://focenter.com) • 508-992-6464 | (800) 473-4237 • [sales@focenter.com](mailto:sales@focenter.com)

23 Centre Street • New Bedford, MA 02740 USA

*Product specifications and data are subject to change without notice.*



**Manufacturer:**  
Dymax







**Product Name:**  
Dymax BlueWave® MX-150 LED Spot-Curing Emitter - 385nm

**Manufacturer Part Number:**  
42337

▶ [Click here for more details on the Dymax BlueWave® MX-150 LED Spot-Curing Emitter - 385nm](#)

## Compatible Materials & Applications

The BlueWave MX-150 is ideally suited for a number of applications in the medical, consumer electronics, automotive, aerospace and defense, optical, and appliance industries. The chart below displays some of the materials commonly used in those industries and where the BlueWave MX-150 can be considered as a curing system.

Materials		
Adhesives		✓ Medical device (catheter, needles, tube set, facemask) assembly; glass bonding (stemware, furniture, etc.); automotive headlamp assemblies; camera module assemblies; appliance assembly; speaker assembly; optical display bonding
Conformal Coatings		✓ Printed circuit board protection in aerospace avionics, automobiles, appliances, and consumer electronics; camera module assembly; electric vehicle battery management systems
Potting Compounds		✓ Tamper proofing; potting electrical connectors, switches, and sensors; cable potting; medical potting*
Maskants		✓ Surface protection for turbine blades and rotorcraft components during processing; protection for surfaces during metal finishing processes; protection of orthopaedic parts during processing; protection of PCB components for consumer electronics, automotive electronics, avionics, and medical electronics; protection for surfaces during metal finishing processes*
Encapsulants		✓ Chip encapsulation on PCBs used in automobiles, plane and helicopter control panels, consumer electronics, appliance, and medical diagnostic equipment*
Ruggedization Materials		Flex circuit reinforcement; wire tacking; ball grid array (BGA) ruggedization; Videos graphics arrays (VGA) ruggedization; shock absorption; underfill alternative

✓ BlueWave MX-150 compatible with this material

\* Materials cured with BlueWave MX-150 to be evaluated in customer application to their performance requirements.

**Contact the professionals at Fiber Optic Center for a quote or to get more details.**

[focenter.com](http://focenter.com) • 508-992-6464 | (800) 473-4237 • [sales@focenter.com](mailto:sales@focenter.com)

23 Centre Street • New Bedford, MA 02740 USA

*Product specifications and data are subject to change without notice.*



**Manufacturer:**  
Dymax

**Product Name:**  
Dymax BlueWave® MX-150 LED Spot-Curing Emitter - 385nm

**Manufacturer Part Number:**  
42337

▶ [Click here for more details on the Dymax BlueWave® MX-150 LED Spot-Curing Emitter - 385nm](#)

## Ordering Information

A complete BlueWave MX-150 system features a controller/power supply and LED emitter. Emitters are available in 365, 385, and 405 nm wavelengths. Lightguides and other accessories noted below can be added for specific applications. Components are sold separately.

Units are warrantied against defects in material and workmanship for one year from date of purchase.



Part Numbers			
<b>LED Emitters   Note: 5-mm lightguide simulator comes with every emitter.</b>			
BlueWave® MX-150 Emitter	42336 RediCure® (365 nm)	42337 PrimeCure® (385 nm)	42338 VisiCure® (405 nm)
<b>Controllers   Note: Interconnect cables to connect controller to emitters and foot pedals sold separately.</b>			
2-Channel Controller	43185 North American Power Cord		
<b>Lightguides and Optics</b>			
Angled Terminators	39029 60° for 3-mm Lightguide	39030 90° for 3-mm Lightguide	
	38042 60° for 5-mm Lightguide	38049 90° for 5-mm Lightguide	

\* All standard Wolf entrance-fitting lightguides will physically couple to this system, but only configurations listed above have been tested and verified to be fully functional.

\*\* The appropriate power cord will be added for European customers.

**Contact the professionals at Fiber Optic Center for a quote or to get more details.**

[focenter.com](http://focenter.com) • 508-992-6464 | (800) 473-4237 • [sales@focenter.com](mailto:sales@focenter.com)

23 Centre Street • New Bedford, MA 02740 USA

*Product specifications and data are subject to change without notice.*



**Manufacturer:**  
Dymax

**Product Name:**  
Dymax BlueWave® MX-150 LED Spot-Curing Emitter - 385nm

**Manufacturer Part Number:**  
42337

▶ [Click here for more details on the Dymax BlueWave® MX-150 LED Spot-Curing Emitter - 385nm](#)

## System Specifications

Property	Specification
Output Frequency	RediCure - 365 nm    PrimeCure - 385 nm    VisiCure - 405 nm
Intensity Output*	RediCure - 24 W/cm <sup>2</sup> PrimeCure - 38 W/cm <sup>2</sup> VisiCure - 36 W/cm <sup>2</sup>
Power Supply Input	100-240V≈ 2.5A, 50-60Hz
LED Timer	0 to 999 seconds
LED Activation	Foot pedal, LCD touch screen, or PLC
Cooling	Air cooled
Dimensions (H x W X D)	Controller: 5.14" x 7.19" x 7.35" (13.1cm x 18.3cm x 18.7cm) Emitter: 7.9" x 1.97" x 1.97" (20.06 cm x 5 cm x 5 cm)
Weight	Controller: 2.6 lbs. (1.18 kg) / Emitter: 1.4 lbs. (0.64 kg)
Unit Warranty	1 year from purchase date
Operating Environment	10-40°C, 0-80% relative humidity, non-condensing

\* Measured using a Dymax ACCU-CAL™ 50-LED Radiometer at a distance of 0 mm.

Figure 1. BlueWave MX-150 Emitter Dimensions

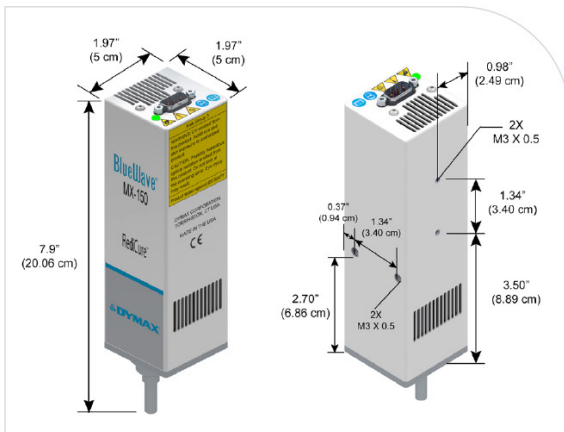
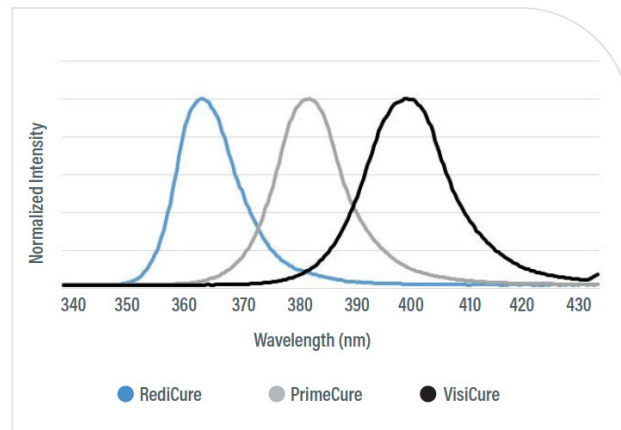

Figure 2. BlueWave MX-150 Spectral Output Chart



**Contact the professionals at Fiber Optic Center for a quote or to get more details.**

[focenter.com](http://focenter.com) • 508-992-6464 | (800) 473-4237 • [sales@focenter.com](mailto:sales@focenter.com)

23 Centre Street • New Bedford, MA 02740 USA

*Product specifications and data are subject to change without notice.*





**Manufacturer:**  
Dymax

**Product Name:**  
Dymax BlueWave® MX-150 LED Spot-Curing Emitter - 385nm

**Manufacturer Part Number:**  
42337

▶ Click here for more details on the Dymax BlueWave® MX-150 LED Spot-Curing Emitter - 385nm

Figure 3. Emitter Intensity at Various Working Distances

Note: Measured with an ACCU-CAL™ 50-LED in both 5-mm lightguide (LG) and flood source modes\*

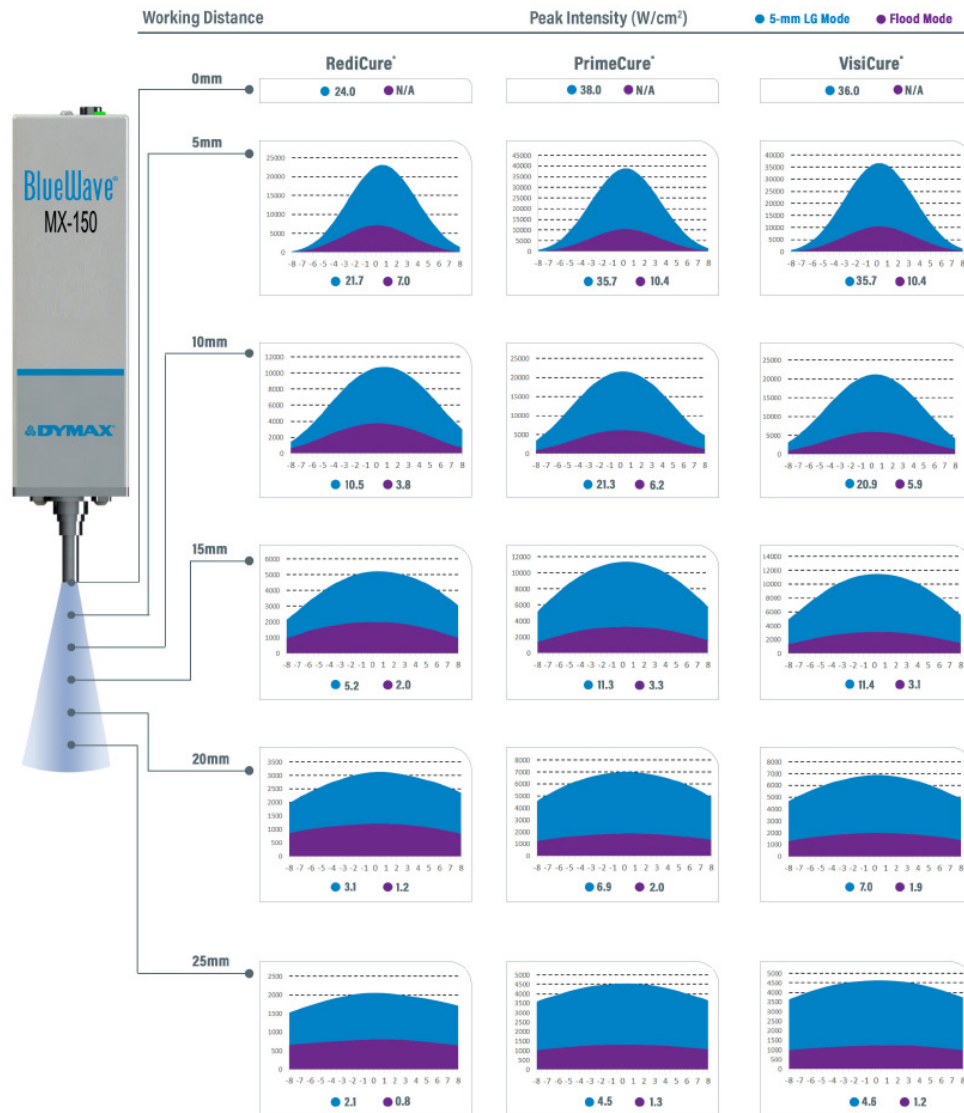

\* Dymax recommends using the 5-mm lightguide source mode on the ACCU-CAL™ 50-LED, when measuring at 0 mm with the provided adapter in the ACCU-CAL kit. If measurements are made at greater working distance, Dymax recommends using the flood mode source for measurements. For convenience, both numbers are provided in this chart.

Contact the professionals at Fiber Optic Center for a quote or to get more details.

[focenter.com](http://focenter.com) • 508-992-6464 | (800) 473-4237 • [sales@focenter.com](mailto:sales@focenter.com)

23 Centre Street • New Bedford, MA 02740 USA

Product specifications and data are subject to change without notice.



**Manufacturer:**  
Dymax

**Product Name:**  
Dymax BlueWave® MX-150 LED Spot-Curing Emitter - 385nm

**Manufacturer Part Number:**  
42337



▶ [Click here for more details on the Dymax BlueWave® MX-150 LED Spot-Curing Emitter - 385nm](#)

## Degradation/Life Testing

Unlike broad-spectrum lamps, LED curing systems do not have bulbs that require regular replacement. Instead, LED curing systems operate with high-intensity LEDs. The instant on/off functioning of LEDs greatly increases the life of these LED systems. Long-term life testing of BlueWave MX-150 systems was conducted for 5,000 continuous hours at 100% and 70% intensity. As noted in the graphs below, LED degradation was found to be very low for all emitter wavelengths and intensities.

### RediCure® (365 nm) Emitters

- 100% Intensity resulted in a 1.7% degradation per 1,000 hours
- 70% Intensity resulted in a 2.0% degradation per 1,000 hours

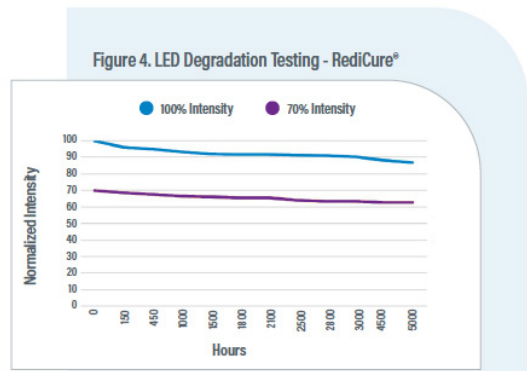

### PrimeCure® (385 nm) Emitters

- 100% Intensity resulted in a 0.1% degradation per 1,000 hours
- 70% Intensity resulted in a 0.6% degradation per 1,000 hours

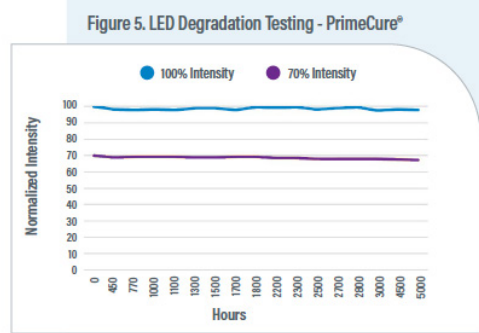

### VisiCure® (405 nm) Emitters

- 100% Intensity resulted in a 0.3% degradation per 1,000 hours
- 70% Intensity resulted in a 0.8% degradation per 1,000 hours

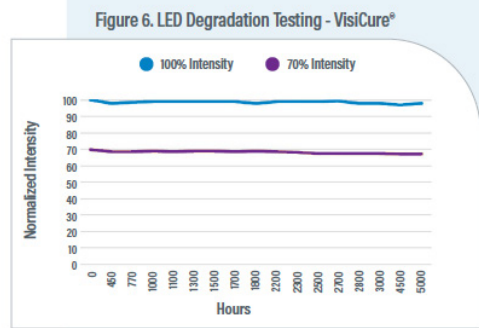

Note: Testing conducted at 70°F +/- 3°F and 30% +/- 10% Relative Humidity

Contact the professionals at Fiber Optic Center for a quote or to get more details.

[focenter.com](http://focenter.com) • 508-992-6464 | (800) 473-4237 • [sales@focenter.com](mailto:sales@focenter.com)

23 Centre Street • New Bedford, MA 02740 USA

Product specifications and data are subject to change without notice.





**Manufacturer:**  
Dymax

**Product Name:**  
Dymax BlueWave® MX-150 LED Spot-Curing Emitter - 385nm

**Manufacturer Part Number:**  
42337

▶ [Click here for more details on the Dymax BlueWave® MX-150 LED Spot-Curing Emitter - 385nm](#)

## Optional Lightguide Configuration

Dedicated optics are not necessary to accommodate larger irradiation areas such as an 8-mm diameter spot. These larger areas can be achieved by increasing the distance between the emitting end of the standard 5-mm optic to ~10 mm.

Figure 7. BlueWave MX-150 with 5-mm Lightguide Simulator, Measured 10 mm from the Surface of the Radiometer

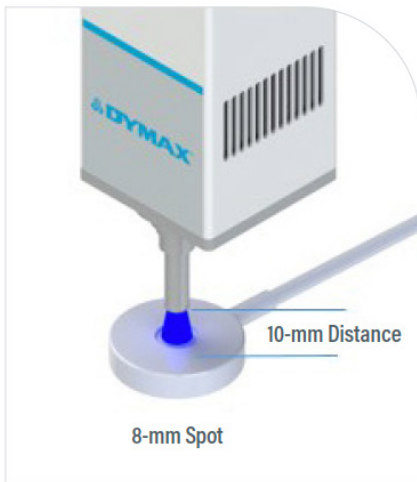
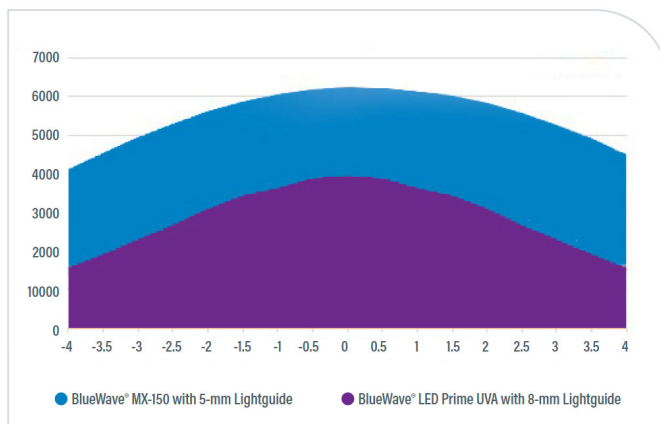

Figure 8. BlueWave® LED Prime Using a 8-mm Lightguide, Measured Directly on the Surface of the Radiometer



Both cover the same target cure area, however, the new BlueWave MX-150 provides a much higher intensity, see chart below.

Figure 9. Intensity Comparison



Note: Intensity measured with an ACCU-CAL™ 50-LED radiometer.

**Contact the professionals at Fiber Optic Center for a quote or to get more details.**

[focenter.com](http://focenter.com) • 508-992-6464 | (800) 473-4237 • [sales@focenter.com](mailto:sales@focenter.com)

23 Centre Street • New Bedford, MA 02740 USA

*Product specifications and data are subject to change without notice.*



**Manufacturer:**  
Dymax

**Product Name:**  
Dymax BlueWave® MX-150 LED Spot-Curing Emitter - 385nm

**Manufacturer Part Number:**  
42337

▶ [Click here for more details on the Dymax BlueWave® MX-150 LED Spot-Curing Emitter - 385nm](#)

The system can be outfitted with a 3 or 5-mm Wolf-style lightguide. A 5-mm lightguide/simulator couples perfectly with the 5-mm aperture of the LED chip (Figure 10) while a 3-mm lightguide only transfers part of the UV light emitted by the LED chip (Figure 11), resulting in lower efficiency. See the intensity chart on the next page for more information.

Figure 10. Aperture with 5-mm Lightguide



Figure 11. Aperture with 3-mm Lightguide



The high intensity of the BlueWave MX-150 can be illustrated by comparing a 3-pole lightguide (PN 37044) to a single-pole lightguide on a Dymax BlueWave LED Prime UVA or BlueWave® LED VisiCure® unit. The intensities of each of the 3 poles on the BlueWave MX-150 is higher in intensity than a single-pole lightguide on those units:

	Average Intensity, W/cm <sup>2</sup>	
	BlueWave MX-150 with 3-Pole Lightguide	BlueWave LED Prime with Single-Pole Lightguide
RediCure®, 365 nm	15	N/A
PrimeCure®, 385 nm	24	15
VisiCure®, 405 nm	22	15

**Contact the professionals at Fiber Optic Center for a quote or to get more details.**

[focenter.com](http://focenter.com) • 508-992-6464 | (800) 473-4237 • [sales@focenter.com](mailto:sales@focenter.com)

23 Centre Street • New Bedford, MA 02740 USA

*Product specifications and data are subject to change without notice.*



**Manufacturer:**  
Dymax

**Product Name:**  
Dymax BlueWave® MX-150 LED Spot-Curing Emitter - 385nm

**Manufacturer Part Number:**  
42337

▶ [Click here for more details on the Dymax BlueWave® MX-150 LED Spot-Curing Emitter - 385nm](#)

Figure 12. PrimeCure, 385 nm - Intensity with a 3- or 5-mm lightguide at Various Working Distances

Note: Measured with an ACCU-CAL™ 50-LED in flood mode.

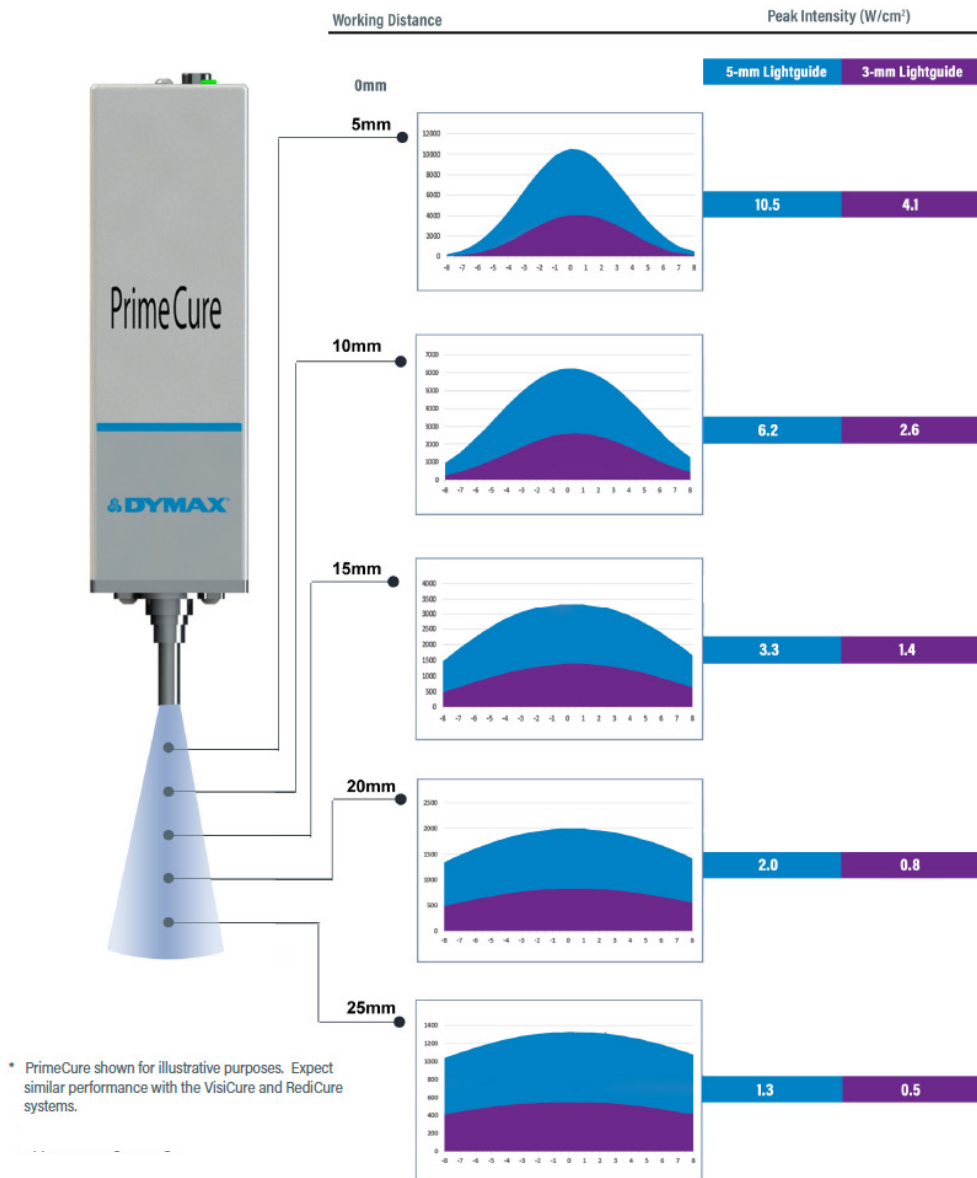

Contact the professionals at Fiber Optic Center for a quote or to get more details.

[focenter.com](http://focenter.com) • 508-992-6464 | (800) 473-4237 • [sales@focenter.com](mailto:sales@focenter.com)

23 Centre Street • New Bedford, MA 02740 USA

Product specifications and data are subject to change without notice.



**Manufacturer:**  
Dymax

**Product Name:**  
Dymax BlueWave® MX-150 LED Spot-Curing Emitter - 385nm

**Manufacturer Part Number:**  
42337

▶ [Click here for more details on the Dymax BlueWave® MX-150 LED Spot-Curing Emitter - 385nm](#)

## Accessories

### Angled Terminators

Angled terminators can be attached to 3 and 5-mm liquid lightguides to provide significant value when delivering curing energy to hard to reach and semi-hidden bond lines.

- Compact, cost effective design
- Available in 60° and 90° versions
- Easy to connect to the BlueWave® MX-150 emitter
- Optimized energy delivery
- Possible for curing in motion and dynamic curing
- Better uniformity with three lightguide terminators or a tri-furcated lightguide, as compared with a bi-furcated lightguide
- Easily mounted to fixture with close working distance

Part Number	Size	Angle	Approximate Loss
39029	3 mm	60°	35%
39030	3 mm	90°	30%
38042	5 mm	60°	35%
38049	5 mm	90°	30%

Figure 13. 5-mm, 90° Terminator (PN 38049)

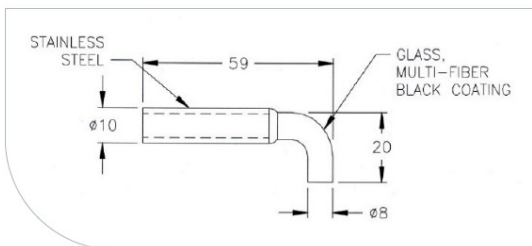
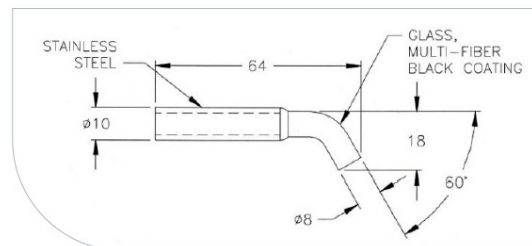

Figure 14. 5-mm, 60° Terminator (PN 38042)



**Contact the professionals at Fiber Optic Center for a quote or to get more details.**

[focenter.com](http://focenter.com) • 508-992-6464 | (800) 473-4237 • [sales@focenter.com](mailto:sales@focenter.com)

23 Centre Street • New Bedford, MA 02740 USA

*Product specifications and data are subject to change without notice.*



**Manufacturer:**  
Dymax

**Product Name:**  
Dymax BlueWave® MX-150 LED Spot-Curing Emitter - 385nm

**Manufacturer Part Number:**  
42337



▶ [Click here for more details on the Dymax BlueWave® MX-150 LED Spot-Curing Emitter - 385nm](#)

Figure 15. Typical Uniformity on the Perimeter of the Cylindrical Curing Target\*

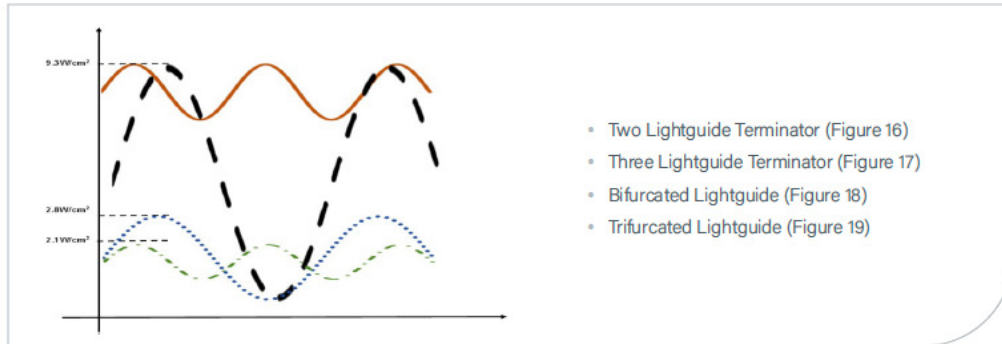

\* The uniformity and intensity vary with the diameter of the curing target and working distance. The intensity is measured using the PrimeCure® and ACCU-CAL™ 50-LED with flood mode, at 0-mm working distance.

Figure 16. Two Lightguide Terminators

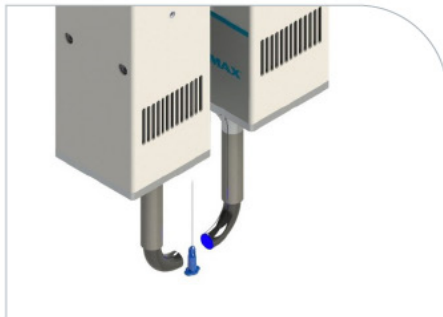

Figure 17. Three Lightguide Terminators

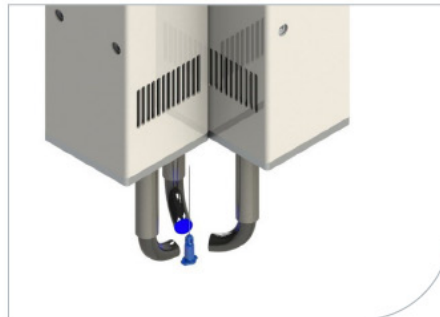

Figure 18. Bifurcated Lightguide



Figure 19. Trifurcated Lightguide



**Contact the professionals at Fiber Optic Center for a quote or to get more details.**

[focenter.com](http://focenter.com) • 508-992-6464 | (800) 473-4237 • [sales@focenter.com](mailto:sales@focenter.com)

23 Centre Street • New Bedford, MA 02740 USA

*Product specifications and data are subject to change without notice.*



**Manufacturer:**  
Dymax

**Product Name:**  
Dymax BlueWave® MX-150 LED Spot-Curing Emitter - 385nm

**Manufacturer Part Number:**  
42337

▶ [Click here for more details on the Dymax BlueWave® MX-150 LED Spot-Curing Emitter - 385nm](#)

### Radiometers

The typical intensity output degradation rate of the unit when run at 100% power and a 100% duty cycle is approximately 7% per 1,000 hours of run time. As with any type of energy source, environmental and operating conditions will have a direct effect on actual degradation rates. Intensity on the BlueWave MX-150 can be measured with a standard ACCU-CAL™ 50-LED. For applications with lightguides, the appropriate standard lightguide adapters should be used and "Lightguide" mode should be selected in the "Source-Mode" section of the optometer. For flood applications, the ACCU-CAL™ 50-LED can be used in flood mode.

### Adjustable Taper Focusing Lens

The adjustable taper focusing lens (PN 41148) can be attached to the BlueWave® MX-150 to provide a focused and adjustable curing area. Uniformity is increased at a distance of 10-20 mm, while intensity is maximized at a 40-50 mm working distance.

Figure 20. ACCU-CAL™ 50-LED



Figure 21. Adjustable Taper Focusing Lens with Dimensions

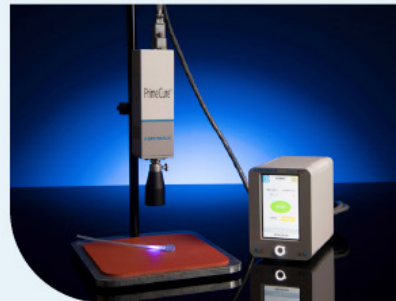
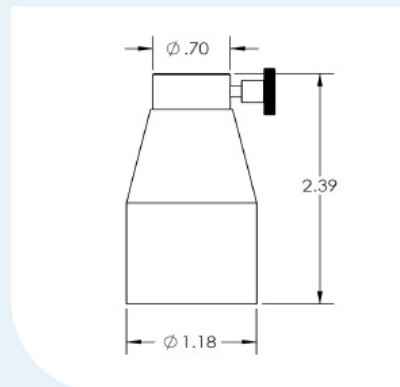

Figure 22. Intensity Measurements, BlueWave MX-150 PrimeCure® Outfitted with Adjustable Taper Shoulder Focusing Lens (PN 41148)



**Contact the professionals at Fiber Optic Center for a quote or to get more details.**

[focenter.com](http://focenter.com) • 508-992-6464 | (800) 473-4237 • [sales@focenter.com](mailto:sales@focenter.com)

23 Centre Street • New Bedford, MA 02740 USA

*Product specifications and data are subject to change without notice.*





**Manufacturer:**  
Dymax

**Product Name:**  
Dymax BlueWave® MX-150 LED Spot-Curing Emitter - 385nm

**Manufacturer Part Number:**  
42337

▶ [Click here for more details on the Dymax BlueWave® MX-150 LED Spot-Curing Emitter - 385nm](#)

Figure 23. Intensity Measurements, BlueWave MX-150 PrimeCure® Outfitted with Adjustable Taper Shoulder Focusing Lens (PN 41148)

Measured with an ACCU-CAL 50-LED in flood source modes\*

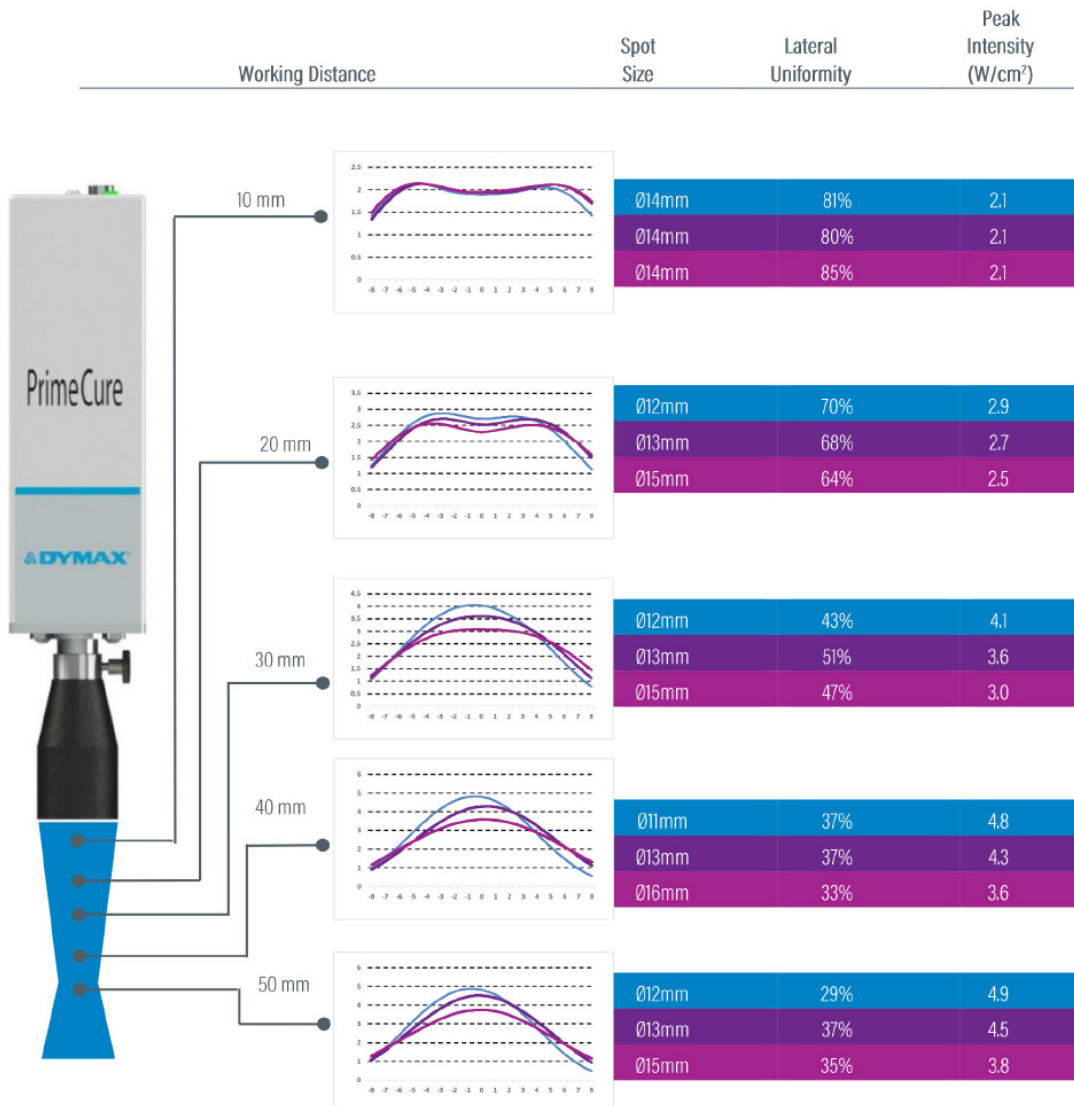

\* Dymax recommends using the flood mode source for measurements. The units of the X-axis in the charts are millimeters (mm). The spot size varies with both the distance of the emitter and the focus change of the lens. By referring this chart, the best combination of spot size, uniformity and intensity can be obtained by adjusting the emitter distance and focus of the lens.

**Contact the professionals at Fiber Optic Center for a quote or to get more details.**

[focenter.com](http://focenter.com) • 508-992-6464 | (800) 473-4237 • [sales@focenter.com](mailto:sales@focenter.com)

23 Centre Street • New Bedford, MA 02740 USA

*Product specifications and data are subject to change without notice.*