

# OPERATING MANUAL



**Manufacturer:**  
Fisnar

**Product Name:**  
Fisnar DC100 MAX Digital Dispensing Machine

**Manufacturer Part Number:**  
DC100 MAX

▶ [Click here for more details on the Fisnar DC100 MAX Digital Dispensing Machine](#)



## DC100 MAX High Precision Digital Dispenser Operating Manual

Contact the professionals at Fiber Optic Center for a quote or to get more details.

[focenter.com](http://focenter.com) • 508-992-6464 | (800) 473-4237 • [sales@focenter.com](mailto:sales@focenter.com)

23 Centre Street • New Bedford, MA 02740 USA

*Product data subject to change  
without notice.*



## Table of Contents

|                           |    |
|---------------------------|----|
| Overview                  | 4  |
| Product Safety Statements | 5  |
| Specifications            | 7  |
| Accessories               | 7  |
| External Controls         | 8  |
| Display Screen            | 11 |
| Keypad Controls           | 12 |
| Machine Setup             | 15 |
| Dispense Setup            | 16 |
| Dispense Modes            | 18 |
| • Purge Mode              | 18 |
| • Teach Mode              | 19 |
| • Timed Mode              | 20 |
| • Time+ Mode              | 22 |
| • Cycle Mode              | 24 |
| Function Menu             | 26 |
| • Program Number          | 28 |
| • Glue Alarm              | 29 |
| • Pressure Alarm          | 31 |
| • Vacuum Alarm            | 33 |
| • Auto Purge              | 35 |
| • Add Time+               | 37 |
| • Cycle Delay             | 38 |
| • Dispense Count          | 39 |
| • Dispense Limit          | 40 |
| • Dispense Time           | 42 |
| • Sequence                | 43 |
| • Shot Actuation          | 47 |
| • Power Button            | 48 |
| • Language                | 49 |
| • Calibration             | 50 |
| • Machine Reset           | 51 |
| • Total Cycles            | 52 |
| • Used Time               | 53 |
| • Machine Copy            | 54 |
| • RS232 Port              | 55 |
| • Pressure Unit           | 56 |
| • Vacuum Unit             | 57 |

Contact the professionals at Fiber Optic Center for a quote or to get more details.

[focenter.com](http://focenter.com) • 508-992-6464 | (800) 473-4237 • [sales@focenter.com](mailto:sales@focenter.com)

23 Centre Street • New Bedford, MA 02740 USA

Product data subject to change without notice.



## Table of Contents

|                                 |           |
|---------------------------------|-----------|
| • Dispense Cancel               | 58        |
| • Change Password               | 59        |
| • Operator Lockout              | 60        |
| <b>Foot Switch Connector</b>    | <b>61</b> |
| <b>I/O Connector</b>            | <b>62</b> |
| • Schematic                     | 62        |
| • Output Signals                | 63        |
| • Input Signals                 | 64        |
| • Output Signal Definition      | 65        |
| • Input Signal Definition       | 66        |
| • Input / Output Signal Testing | 68        |
| <b>RS232 Connector</b>          | <b>70</b> |
| • Barcode Scanner               | 70        |
| • RS232 External Control        | 71        |
| <b>Spare Parts List</b>         | <b>72</b> |
| <b>Technical Drawing</b>        | <b>74</b> |
| <b>Appendix</b>                 | <b>75</b> |
| • Appendix 1                    | 75        |
| • Appendix 2                    | 76        |

**Contact the professionals at Fiber Optic Center for a quote or to get more details.**

[focenter.com](http://focenter.com) • 508-992-6464 | (800) 473-4237 • [sales@focenter.com](mailto:sales@focenter.com)

23 Centre Street • New Bedford, MA 02740 USA

*Product data subject to change without notice.*



## OVERVIEW



**Model DC100 MAX Digital Dispenser**

The DC100 MAX is a versatile, high precision dispenser designed to achieve exceptional levels of process stability in critical dispense applications: from microdot deposits and precise beads, to potting and encapsulation. The advanced user-friendly dispense software features a wide range of intelligent functions, allowing the user to maximize accuracy, control and monitoring of their dispensing process.













Programmable alarms can be set to notify the user when fluid material life has ended, or when fluctuations in the dispensing pressure have occurred. The sequence function enables the dispense time to be changed at pre-set time intervals or shots. This ensures consistent dispense results from the start to finish of the process, due to fluid viscosity changes or reduction in the syringe fluid level being accounted for.

- Digital dispensing parameters, precision regulator, vacuum control and high flow solenoid ensure high accuracy repeatable dispense results.
- 16 programmable memory slots
- 5 dispense modes (Purge, Teach, Timed, Time+, Cycle)
- Multilingual Display, digitally displaying dispense time, pressure and vacuum
- 13 channel I/O circuit for external program change, dispense actuation, machine status and alarm monitoring & signaling.
- I/O test mode
- Momentary or Latching shot actuation signal
- RS232 port for external control, monitoring and programming of dispense parameters
- Internal pressure and vacuum calibration function
- Operator lockout function prevents dispense programs and functions from being modified
- Pressure and Vacuum alarm for maintaining consistent dispense parameters
- Auto-purge cycle and glue alarm prevents premature curing when dispensing 2K fluid materials
- Option to attach barcode scanner for touch-free program selection and dispense actuation

**Contact the professionals at Fiber Optic Center for a quote or to get more details.**

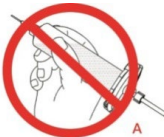
[focenter.com](http://focenter.com) • 508-992-6464 | (800) 473-4237 • [sales@focenter.com](mailto:sales@focenter.com)

23 Centre Street • New Bedford, MA 02740 USA

| <b>SAFETY</b>  |   |
|--|---|
| <b>General Precautions</b>   |   |
|   | <b><i>Do not operate the machine in excess of its maximum ratings / settings.</i></b>   |
|   | <b><i>Make sure that the input air supply is clean and dry. A 5 micron air filter/regulator (560567) is recommended to ensure the input air supply is clean and dry.</i></b>  |
|   | <b><i>If corrosive or flammable fluids are being used, a syringe barrel adapter head assembly with inline filter must be used, to help prevent the fluids from being sucked back into the machine.</i></b>  |
|   | <b><i>The fluid being dispensed may be toxic and / or hazardous. Refer to the Material Safety Data Sheet for proper handling and safety precautions.</i></b>  |
|   | <b><i>Do not smoke or use near an open flame when flammable materials are being dispensed.</i></b>  |
|   | <b><i>Do not expose the machine directly to sunlight.</i></b>   |
|   | <b><i>Avoid cleaning the machine with aggressive solvents – neutral detergents are preferred.</i></b>   |
|   | <b><i>Do not overfill the barrel and/or lay the barrel on its side. This will prevent fluids from flowing back into the machine – refer to figures A &amp; B below.</i></b>   |
|   |   |
| <b>DC100 MAX Malfunction</b>   |   |
|   | <b><i>If the machine malfunctions, shut down the machine immediately. This can be done by either pressing the power button on the front of the machine or disconnecting the power cord.</i></b>   |
|   | <b><i>Always use a piston with the barrel to prevent fluids from flowing back into the machine</i></b>  |
|   | <b><i>When dispensing low viscosity fluids that require the vacuum be aware not to increase to a point where fluids begin to run back into the air line potentially reaching the control box. The vacuum should not be set too high or it will cause material to creep backwards.</i></b> |

**Contact the professionals at Fiber Optic Center for a quote or to get more details.**

[focenter.com](http://focenter.com) • 508-992-6464 | (800) 473-4237 • [sales@focenter.com](mailto:sales@focenter.com)

23 Centre Street • New Bedford, MA 02740 USA





*Product data subject to change without notice.*



## SAFETY





### Inappropriate Use

If the machine is used in a way other than described in this manual, it may cause damage to self or property.

|   |   |
|---|---|
|  | <b>Do not use any components with the machine other than Fisnar authorized components.</b>                            |
|  | <b>Do not use incompatible materials.</b>   |
|  | <b>Do not make any modifications to the machine.<br/>All repairs must be done using Fisnar specified spare parts.</b> |
|  | <b>Do not operate the machine in excess of its maximum ratings / settings.</b>  |





### Fire Prevention

Refer to the following instructions to avoid any fire or explosion.

|   |   |
|---|---|
|    | <b>Access your surroundings and the location of the nearest fire extinguisher and Emergency Exit.</b> |
|   | <b>Do not smoke or use near an open flame when flammable materials are being dispensed.</b>           |
|  | <b>Immediately disconnect power if any sparking or smoke appears.</b>                                 |
|  | <b>Do not expose the machine directly to sunlight.</b>  |

### Maintenance

The DC100 MAX is generally a maintenance free machine. However, to ensure smooth operation please follow the below instructions.

|   |  |
|---|--|
|  | <b>Only use non-woven cleaners on the machine.</b>   |
|  | <b>Avoid cleaning the machine with aggressive solvents – neutral detergents are preferred.</b>         |
|  | <b>Ensure that compressed air supply to the machine is clean and moisture free.</b>                    |
|  | <b>Do not lay the barrel on its side. This will prevent fluids from flowing back into the machine.</b> |

Contact the professionals at Fiber Optic Center for a quote or to get more details.

| SPECIFICATIONS               |  |
|------------------------------|--|
| Dimensions (W x D x H):      | 7.56" x 5.04" x 3.00" (192 x 128 x 76 mm)            |
| Weight:                      | 2.31 lbs. (1.05 kg)                                  |
| Input AC to Power Supply:    | 100 – 240 VAC, 50 / 60 Hz                            |
| Output DC from Power Supply: | 24 VDC – 0.75 Amp                                    |
| Cycle Rate:                  | Up to 600 cycles / min                               |
| Relative Humidity:           | 20 – 90% (No Condensation)                           |
| Operating Temperature:       | 50 – 104°F (10 – 40°C)                               |
| Timer:                       | 0.008 – 999.9 seconds                                |
| Air Input:                   | 100 psi (7 bar) max                                  |
| Air Output:                  | 1 – 100 psi (0.07 – 7 bar)                           |
| Standards:                   | CE & UKCA Approved, EMC Compliant.<br>RoHS Compliant |

| ACCESSORIES |   |          |
|-------------|---|----------|
| Item        | Description   | Quantity |
| 5601890     | Power Adaptor (Input: 100 – 240 VAC / Output: 24 VDC)     | 1        |
| 5601888     | Foot Pedal  | 1        |
| 561851      | Air Inlet Hose Assembly                                   | 1        |
| 5601969     | FSX Syringe Barrel Stand                                  | 1        |
| 5779K712    | Push To Connect Tube Fitting 1/4" Stem OD X 5/32" Tube OD | 1        |

**Note:** Consumable kit (part # QK-CSK) & needle sample kit (part # QK-NSK) available to purchase separately.



Part # QK-CSK



Part # QK-NSK

**Contact the professionals at Fiber Optic Center for a quote or to get more details.**

[focenter.com](http://focenter.com) • 508-992-6464 | (800) 473-4237 • [sales@focenter.com](mailto:sales@focenter.com)

23 Centre Street • New Bedford, MA 02740 USA

*Product data subject to change without notice.*

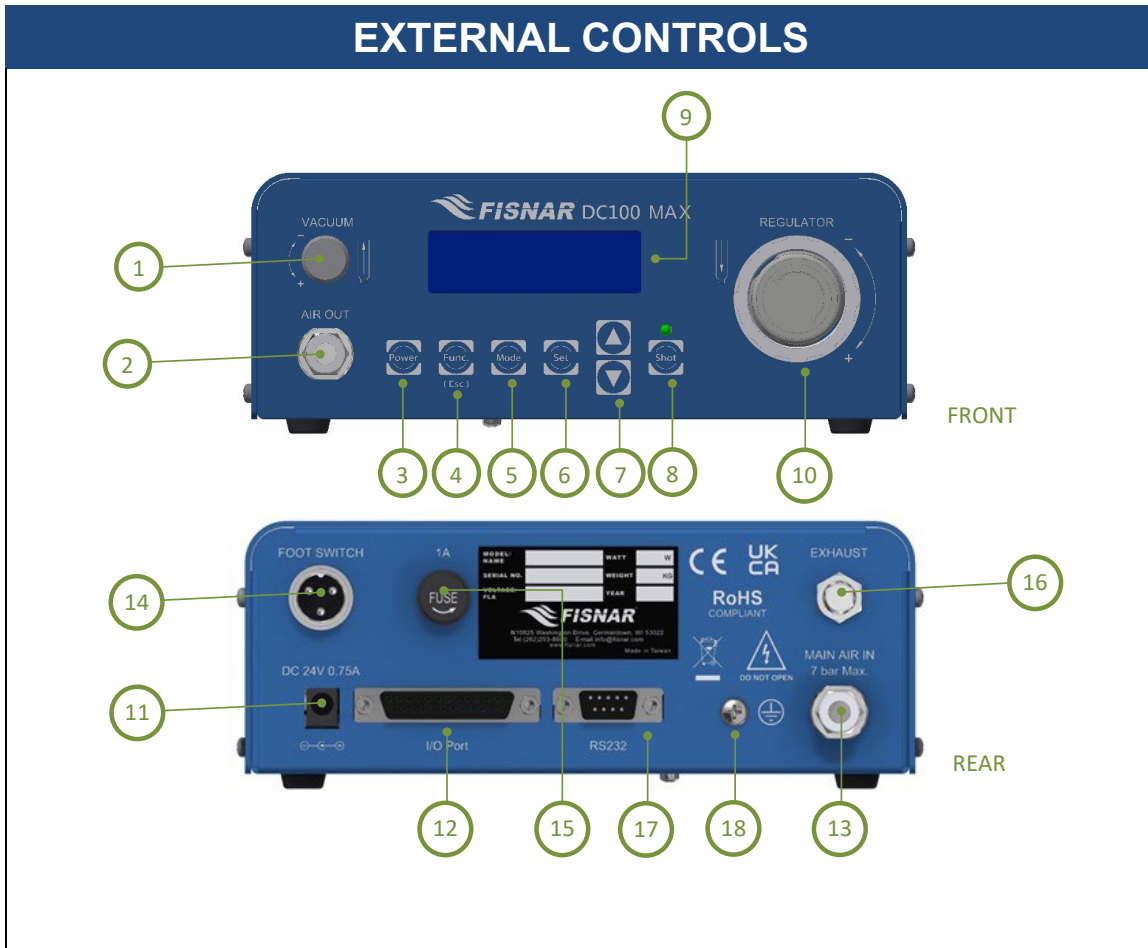

| Item | Illustration             | Item | Illustration           | Item | Illustration          |
|------|--------------------------|------|------------------------|------|-----------------------|
| 1    | Vacuum Control           | 7    | Scroll Buttons         | 13   | Air In Port           |
| 2    | Air Out Port             | 8    | Shot Button            | 14   | Foot Switch Connector |
| 3    | Power Button             | 9    | Display                | 15   | Fuse                  |
| 4    | Function / Escape Button | 10   | Air Pressure Regulator | 16   | Exhaust Port          |
| 5    | Mode Button              | 11   | Power Input Connector  | 17   | RS232 Connector       |
| 6    | Set Button               | 12   | I/O Connector          | 18   | Grounding Point       |

Contact the professionals at Fiber Optic Center for a quote or to get more details.

[focenter.com](http://focenter.com) • 508-992-6464 | (800) 473-4237 • [sales@focenter.com](mailto:sales@focenter.com)

23 Centre Street • New Bedford, MA 02740 USA

Product data subject to change without notice.



## EXTERNAL CONTROLS



|           |                    |  |
|-----------|--------------------|--|
| <b>1.</b> | Suck Back Control  | Keeps a negative air pressure in the syringe barrel when not dispensing. Required to prevent low viscosity fluids dripping from the dispense tip in between dispense cycles.   |
| <b>2.</b> | Air Out Port       | The syringe barrel adapter head assembly is connected here.  |
| <b>3.</b> | Display Screen     | Shows the current program number, dispense mode, parameter values and active function alarms of the machine.<br><br>For further information, please refer to display screen overview.  |
| <b>4.</b> | Pressure Regulator | Adjusts the amount of pressure being used to dispense fluid from the syringe barrel. To reach the desired pressure, turn the knob counterclockwise to a point below the required pressure, and then turn the knob clockwise to reach the required pressure.<br><br>The regulator can be locked into position by tightening the jam nut behind the knob against the regulator body on the front panel of the machine. |

**Contact the professionals at Fiber Optic Center for a quote or to get more details.**

[focenter.com](http://focenter.com) • 508-992-6464 | (800) 473-4237 • [sales@focenter.com](mailto:sales@focenter.com)

23 Centre Street • New Bedford, MA 02740 USA

*Product data subject to change without notice.*



## EXTERNAL CONTROLS



|    |                       |  |
|----|-----------------------|--|
| 1. | Foot Switch Connector | The foot pedal switch is connected here. Alternatively, it can be used for connecting to an external device (e.g. Fisnar dispense robot) that will send the dispense start signal to the machine.                                  |
| 2. | Fuse                  | The machine fuse is located here.  |
| 3. | Power Input Connector | Power input cable from the external power supply is connected here.  |
| 4. | I/O Connector         | Where the external machine I/O input signals and output signals are connected.<br><br>A courtesy 24V + output is also included on the I/O Connector  |
| 5. | RS232 Connector       | Used for externally programming and controlling the machine. Alternatively, a barcode scanner can be plugged into this connector.  |
| 6. | Grounding Point       | A wire from an external earth ground source within the workplace environment can be connected here to ensure the machine is permanently and safely grounded.   |
| 7. | Air In Port           | External Compressed air 70-100 psi (5-7 bar) is connected here, using the supplied 1/4" OD air inlet hose.   |
| 8. | Exhaust               | When the suck-back control is in use, air will be exhausted from this port in between dispense cycles.<br><br>A muffler (560024-DCHF) can be fitted into the exhaust outlet port to reduce the emitted noise of the exhausted air. |

**Contact the professionals at Fiber Optic Center for a quote or to get more details.**

[focenter.com](http://focenter.com) • 508-992-6464 | (800) 473-4237 • [sales@focenter.com](mailto:sales@focenter.com)

23 Centre Street • New Bedford, MA 02740 USA

### DISPLAY SCREEN

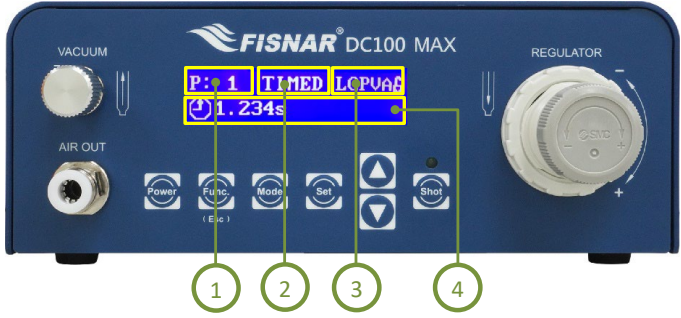

|    |                  |  |
|----|------------------|--|
| 1. | Program Number   | Displays the currently selected program number. Up to sixteen (16) individual programs can be saved to the machine for future recall.                |
| 2. | Dispense Mode    | Displays the current mode the saving program is in. There are five (5) dispense modes available: PURGE, TEACH, TIMED, TIME+ and CYCLE.               |
| 3. | Function Alarms  | Displays which feature(s) are currently turned ON. I.E. Dispense Limit (L), Glue Alarm (G), Pressure Alarm (P), Vacuum Alarm (V) and Auto Purge (A). |
| 4. | Parameter Values | Displays the values of the machine parameters (i.e. dispensing time, pressure and/or vacuum).  |

**Contact the professionals at Fiber Optic Center for a quote or to get more details.**

[focenter.com](http://focenter.com) • 508-992-6464 | (800) 473-4237 • [sales@focenter.com](mailto:sales@focenter.com)









23 Centre Street • New Bedford, MA 02740 USA

*Product data subject to change without notice.*











## KEYPAD CONTROLS



|    |  |  |
|----|--|--|
| 1. | Power On / Off                             | Press the  button to switch the machine ON or OFF.  |
| 2. | Function Menu                              | Press the  button to enter into the function menu.  |
| 3. | Dispense Mode                              | Press the  button to select the dispense mode that the program will operate in (i.e. PURGE, TEACH, TIMED, TIME+, CYCLE).  |
| 4. | Set Dispense Time / Function Menu Navigate | <p>Press the  button to set the dispense time. Use the  or  buttons to change the individual numeric value. The digit displaying the “_” below it, is the one that will be adjusted.</p> <p>Continue to press the  button to scroll through the digit positions, adjusting the numerical values as required.</p> <p>When the  button is pressed after the first digit from the left is displaying “_” below it, the “_” will move to below the decimal place.</p> |

Contact the professionals at Fiber Optic Center for a quote or to get more details.

|           |                          |   |
|-----------|--------------------------|---|
|           |                          | <p>Use the  or  buttons to move the decimal place into the correct needed position.</p> <p>The  button can continue to be pressed to cycle through the digit and decimal place positions in a continuous scrolling cycle.</p> <p>When the dispense time has been correctly set, press and hold the  button for approximately two (2) seconds to save the dispense time and exit back to the home screen.</p> <p>When in the function menu, the  button is used to enter into the function setting and then used to scroll through the different parameter values within the function setting.</p> |
| <p>5.</p> | <p>Parameter Display</p> | <p>Press the  or  button to scroll through the different parameter display screens.</p> <p><b>Dispense Time</b></p>   |





**Contact the professionals at Fiber Optic Center for a quote or to get more details.**

[focenter.com](http://focenter.com) • 508-992-6464 | (800) 473-4237 • [sales@focenter.com](mailto:sales@focenter.com)

23 Centre Street • New Bedford, MA 02740 USA

*Product data subject to change without notice.*



|                                       |                      |  |
|---------------------------------------|----------------------|--|
|                                       |                      | <p><b>Dispense Time and Vacuum</b></p>  <p><b>Dispense Time and Pressure</b></p>  <p><b>Dispense Limit, Glue Alarm and Auto Purge</b></p>  |
| <p>6.</p>                             | <p>Dispense Shot</p> | <p>Press the  button to actuate the machine and begin dispensing fluid.</p>   |
| Empty row for additional instructions |                      |  |

Contact the professionals at Fiber Optic Center for a quote or to get more details.

[focenter.com](http://focenter.com) • 508-992-6464 | (800) 473-4237 • [sales@focenter.com](mailto:sales@focenter.com)

23 Centre Street • New Bedford, MA 02740 USA

Product data subject to change without notice.

## MACHINE SETUP

|    |   |
|----|---|
| 1. | Connect the air hose from a compressed air supply source 70-100 psi (5-7 bar) to the “Air In” port on the back of the machine.                            |
| 2. | Insert the foot pedal connector plug into the “Foot Switch” connector on the back of the machine.   |
| 3. | Attach the appropriate country type plug adapter onto the power supply and then connect the electrical power cord to the port on the back of the machine. |
| 4. | Connect the end of the adapter head assembly with the green colored push to connect fitting, to the “Air Out” port on the front of the machine.           |

**Contact the professionals at Fiber Optic Center for a quote or to get more details.**

[focenter.com](http://focenter.com) • 508-992-6464 | (800) 473-4237 • [sales@focenter.com](mailto:sales@focenter.com)

23 Centre Street • New Bedford, MA 02740 USA

*Product data subject to change without notice.*



## DISPENSE SETUP

Attach the syringe barrel adapter head assembly to the syringe barrel (with piston fitted inside) as shown below. See FIG. 1 (A – C).

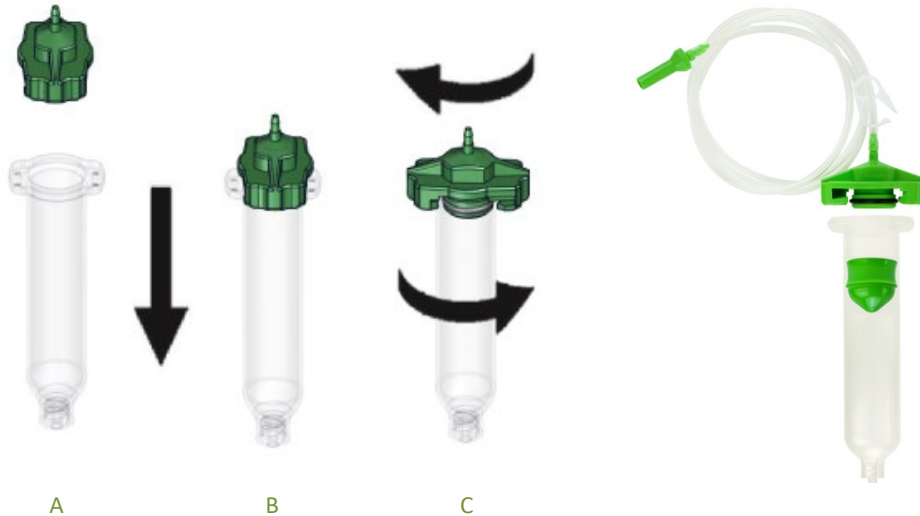
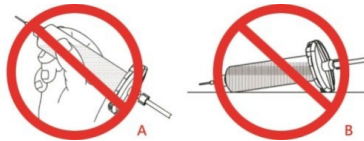

FIG. 1: Dispense Setup

**Do not overfill the syringe barrel and/or lay the syringe barrel on its side. This will prevent fluids from flowing back into the machine – refer to figures A & B below. Place the filled syringe barrel in the supplied syringe barrel stand (5601969) when not being used.**





|    |   |
|----|---|
| 1. | Connect the syringe barrel adapter head assembly to the “Air Out” port on the front of the machine. Fisnar adapter head assemblies are fitted with a green colored push to connect fitting (5606038) that can be inserted directly into the “Air Out” port on the front of the machine.   |
| 2. | <p>If a syringe barrel adapter head assembly with 5/32” OD tubing is being used with the machine that has a bayonet fitting attached to the end of it, make sure to cut the bayonet fitting off from the tubing first. Then install the included push to connect air adapter fitting (5779K712) onto the tubing and insert it into the “Air Out” port on the front of the machine.</p> <p>If a syringe barrel adapter head assembly with 1/4” OD tubing is being used with the machine, cut the bayonet fitting off from the tubing and insert it directly into the “Air Out” port.</p> |

**Contact the professionals at Fiber Optic Center for a quote or to get more details.**



**DC100 MAX Digital Dispenser Operating Manual**



|           |   |
|-----------|---|
| <p>3.</p> | <p>When not being used, the syringe barrel should be placed in the syringe barrel stand provided. This will prevent the dispense tip from being accidentally damaged or having fluid inside the syringe barrel flow back into the machine if it is placed horizontally on the work surface.</p> <p>The bottle it is placed into, allows any fluid that drips from the dispense tip to be safely captured. The dispense tip is also protected in the bottle from any foreign contaminants or environmental lighting that may affect the properties of the fluid within it.</p>  |
| <p>4.</p> | <p>Purge trays are provided with the syringe stand to allow for a small amount of fluid to be purged into a clean and contained location. This is also helpful when a new dispense tip is attached to the syringe barrel or when checking for accurate fluid material flow. This is helpful for ensuring optimum dispense results.</p>    |

**Contact the professionals at Fiber Optic Center for a quote or to get more details.**

[focenter.com](http://focenter.com) • 508-992-6464 | (800) 473-4237 • [sales@focenter.com](mailto:sales@focenter.com)

23 Centre Street • New Bedford, MA 02740 USA





*Product data subject to change without notice.*



## DISPENSE MODES









### PURGE MODE

|    |  |
|----|--|
| 1. | <p>Press the  button until "PURGE" mode is displayed.</p> <p>PURGE mode allows the operator to actuate the machine on demand whenever the dispense signal is activated (i.e. foot pedal is pressed).</p>   |
| 2. | <p>Press the foot pedal or the  button to actuate the machine and begin dispensing fluid. Release the foot pedal or  button to stop dispensing fluid.</p> <p>The machine will count up from zero (0) seconds the amount of time you are dispensing fluid while the foot pedal or  button is pressed.</p> <p>The TIME shown on the digital display after the foot pedal or  button has been released, will reset to zero (0) seconds every time the machine is actuated.</p> |

**Contact the professionals at Fiber Optic Center for a quote or to get more details.**

[focenter.com](http://focenter.com) • 508-992-6464 | (800) 473-4237 • [sales@focenter.com](mailto:sales@focenter.com)

23 Centre Street • New Bedford, MA 02740 USA

| <b>DISPENSE MODES</b>  |  |
|--|--|
|  |  |
| <b>TEACH MODE</b>  |  |
| <b>1.</b>  | <p>Press the  button until “TEACH” mode is displayed.</p> <p>TEACH mode allows the operator to calculate the correct dispense time needed for the application process. This is useful when carrying out a potting process.</p>  |
| <b>2.</b>  | <p>Press the foot pedal or the  button to actuate the machine and begin dispensing fluid. Release the foot pedal or  button to stop dispensing fluid. The TIME shown will increase cumulatively every time the machine is actuated.</p> <p>If or when needed, press and hold the  button to reset the timer to zero (0).</p> |
| <b>3.</b>  | <p>The time shown on the screen will be the total cumulative time the machine has been actuated for.</p> <p>Once the correct dispense time is obtained, press the  button to switch to TIMED, TIME+ or CYCLE mode to save the value.</p>  |

**Contact the professionals at Fiber Optic Center for a quote or to get more details.**

[focenter.com](http://focenter.com) • 508-992-6464 | (800) 473-4237 • [sales@focenter.com](mailto:sales@focenter.com)

23 Centre Street • New Bedford, MA 02740 USA

*Product data subject to change without notice.*



## DISPENSE MODES



### TIMED MODE





|    |  |
|----|--|
| 1. | <p style="text-align: center;"></p> <p>Press the  button until "TIMED" mode is displayed.</p> <p>TIMED mode allows the operator to dispense fluid for a set period, regardless of how long the foot pedal is pressed.</p>  |
| 2. | <p style="text-align: center;"></p> <p>Press the  button to set the dispense time. Use the  or  buttons to change the individual numeric value. The digit displaying the "_" below it, is the one that will be adjusted.</p> <p style="text-align: center;"></p> <p>Continue to press the  button to scroll through the digit positions, adjusting the numerical values as required.</p> <p style="text-align: center;"></p> <p>When the  button is pressed after the first digit from the left is displaying "_" below it, the "_" will move to below the decimal place. Use the  or  buttons to move the decimal place into the correct needed position.</p> |

**Contact the professionals at Fiber Optic Center for a quote or to get more details.**

[focenter.com](http://focenter.com) • 508-992-6464 | (800) 473-4237 • [sales@focenter.com](mailto:sales@focenter.com)

23 Centre Street • New Bedford, MA 02740 USA

*Product data subject to change without notice.*

|    |   |
|----|---|
|    | <p>The  button can continue to be pressed to cycle through the digit and decimal place positions in a continuous scrolling cycle.</p> <p>When the dispense time has been correctly set, press and hold the  button for approximately two (2) seconds to save the dispense time and exit back to the home screen.</p>  |
| 3. | <p>Press the foot pedal or the  button to actuate the machine and begin dispensing fluid.</p> <p>The dispense time will automatically start counting downwards from the set dispense time until it reaches zero (0) seconds.</p> <p>When the dispense time reaches zero (0) seconds, the machine will automatically stop dispensing and the dispense time will reset back to the set dispense time.</p> <p>The dispense cycle can be stopped before the dispense time reaches zero (0) by pressing the  button.</p> <p>If the “Dispense Cancel” function has been enabled, the dispense cycle can also be stopped before the dispense time reaches zero (0) by pressing the foot pedal or the  button.</p> |
|    |   |





**Contact the professionals at Fiber Optic Center for a quote or to get more details.**

[focenter.com](http://focenter.com) • 508-992-6464 | (800) 473-4237 • [sales@focenter.com](mailto:sales@focenter.com)

23 Centre Street • New Bedford, MA 02740 USA

*Product data subject to change without notice.*









| <b>DISPENSE MODES</b>  |   |
|--|---|
|  |   |
| <b>TIME+ MODE</b>  |   |
| <b>1.</b>  | <p>Press the  button until "TIME+" mode is displayed.</p> <p>TIME+ mode allows the operator to adjust the timed shot on the fly by a set amount as and when needed by pressing the  button. This is useful for making slight adjustments on the dispense time without changing the original value in TIMED mode.</p> <p>This mode can be suitable for sensitive (temperature, humidity, short pot life, etc.) materials that require the dispense time value to be increased over an uncontrolled period of time determined by the operator to improve dispense repeatability over the longevity of the fluid being dispensed from the syringe barrel until it is empty.</p> |
| <b>2.</b>  | <p>Press the foot pedal or the  button to actuate the machine and begin dispensing fluid.</p> <p>The dispense time will automatically start counting downwards from the set dispense time until it reaches zero (0) seconds.</p>   |

**Contact the professionals at Fiber Optic Center for a quote or to get more details.**

[focenter.com](http://focenter.com) • 508-992-6464 | (800) 473-4237 • [sales@focenter.com](mailto:sales@focenter.com)

23 Centre Street • New Bedford, MA 02740 USA

*Product data subject to change without notice.*

|           |   |
|-----------|---|
|           | <p>When the dispense time reaches zero (0) seconds, the machine will automatically stop dispensing and the dispense time will reset back to the set dispense time.</p> <p>The dispense cycle can be stopped before the dispense time reaches zero (0) by pressing the  button.</p> <p>If the “Dispense Cancel” function has been enabled, the dispense cycle can also be stopped before the dispense time reaches zero (0) by pressing the foot pedal or the  button.</p>                       |
| <p>3.</p> | <p>When needed, press the  button to add the time set in the “Add Time+” function to the dispense time value. The  button can continue to be pressed to further increase the dispense time cumulatively based upon the time set in the “Add Time+” function setting.</p> <p>Press and hold the  button to reset the adjusted dispense time back to the original set dispense time value in TIMED mode.</p> |
| <p>4.</p> | <p>To reset the dispense time back to the original set dispense time value in TIMED mode, press and hold the  button.</p> <p>The dispense time value displayed under TIME+ mode will not affect the values in other modes (i.e. TIMED, TEACH, CYCLE). However, changing the time value in other modes will also change the value in TIME+ mode.</p>  |
|           |   |

**Contact the professionals at Fiber Optic Center for a quote or to get more details.**

[focenter.com](http://focenter.com) • 508-992-6464 | (800) 473-4237 • [sales@focenter.com](mailto:sales@focenter.com)

23 Centre Street • New Bedford, MA 02740 USA









*Product data subject to change without notice.*



## DISPENSE MODES



### CYCLE MODE







|    |   |
|----|---|
| 1. | <p>Press the  button until "CYCLE" mode is displayed.</p> <p>CYCLE mode allows the operator to create a repeating cycle of dispense actuations. For example, dispense for 1 second and then wait for 3 seconds, and cycle these times over and over again.</p>  |
| 2. | <p>Press the  button to set the dispense time. Use the   buttons to change the individual numeric value. The digit displaying the "_" below it, is the one that will be adjusted.</p> <p>Continue to press the  button to scroll through the digit positions, adjusting the numerical values as required.</p> <p>When the  button is pressed after the first digit from the left is displaying "_" below it, the "_" will move to below the decimal place. Use the   buttons to move the decimal place into the correct needed position.</p> |

**Contact the professionals at Fiber Optic Center for a quote or to get more details.**



**DC100 MAX Digital Dispenser Operating Manual**



|                  |   |
|------------------|---|
|                  | <p>The  button can continue to be pressed to cycle through the digit and decimal place positions in a continuous scrolling cycle.</p> <p>When the dispense time has been correctly set, press and hold the  button for approximately two (2) seconds to save the dispense time and exit back to the home screen.</p>  |
| <p><b>3.</b></p> | <p>Press the foot pedal or the  button to actuate the machine and begin dispensing fluid.</p> <p>The dispense time will automatically start counting downwards from the set dispense time until it reaches zero (0) seconds.</p> <p>When the dispense time reaches zero (0) seconds, the machine will automatically stop dispensing and the dispense time will reset back to the set dispense time.</p> <p>The machine will then automatically start counting down from the time set in the “Cycle Delay” function setting until it reaches zero (0) seconds.</p> <p>Once the machine has counted down to zero (0) seconds, it will automatically begin dispensing fluid again according to the set dispense time until it reaches zero (0) seconds.</p> <p>The dispense cycle can be stopped before the dispense time reaches zero (0) by pressing the  button.</p> <p>This looping cycle will continue to be repeated until the  or  button is pressed again.</p> <p>A full shot cycle is counted towards the cumulative dispense counter whenever the dispense timer reaches zero (0).</p> |

**Contact the professionals at Fiber Optic Center for a quote or to get more details.**

[focenter.com](http://focenter.com) • 508-992-6464 | (800) 473-4237 • [sales@focenter.com](mailto:sales@focenter.com)

23 Centre Street • New Bedford, MA 02740 USA





*Product data subject to change without notice.*



## FUNCTION MENU

The machine offers built-in functions that provide additional control and adjustment to the dispense application and machine settings.

**Instructions:**

- Press the  button to enter the Function menu.
- Press the  buttons to scroll through the available function settings.
- Press the  button to enter into the selected function setting and adjust/set as needed.
- Press the  button to exit the function menu.

**Overview:**

| Function Setting  | Description  |
|-------------------|--|
| 1. Program Number | Sets the program number that the machine will operate in.  |
| 2. Glue Alarm     | Sets the amount of time that the machine will operate for, before an alarm signal is automatically activated preventing the machine from being actuated.                                     |
| 3. Pressure Alarm | Sets the pressure and tolerance required for optimum dispensing conditions.  |
| 4. Vacuum Alarm   | Sets the vacuum and tolerance required for optimum dispensing conditions.  |
| 5. Auto purge     | Sets the dispense time and delay time for automatic purging of material.   |
| 6. Add Time+      | Sets the amount of time added to the TIME+ value when the “Set” button is pressed.   |
| 7. Cycle Delay    | Sets the amount of time that the machine will remain idle for after executing a dispense cycle, before automatically actuating the next dispense cycle, when the machine is in “CYCLE” mode. |

**Contact the professionals at Fiber Optic Center for a quote or to get more details.**

**DC100 MAX Digital Dispenser Operating Manual**



|                      |   |
|----------------------|---|
| 8. Dispense Count    | Displays the total number of dispense cycles made per work cycle. This counter is resettable.                                     |
| 9. Dispense Limit    | Sets the total number of dispense cycles that the machine is able to complete.  |
| 10. Dispense Time    | Displays the total dispense time made per work cycle. This timer is resettable.   |
| 11. Sequence         | Allows the user to create and run a sequence of programs one after the other  |
| 12. Shot Actuation   | Sets if the dispense actuation signal will work as a momentary or latching type.  |
| 13. Power Button     | Sets if the machine automatically turns on when power is applied, or switches on when the power button is pressed.                |
| 14. Language         | Choose LCD display language.  |
| 15. Calibration      | Calibrates the digital pressure and vacuum gauge to the atmospheric and environmental conditions where the machine is being used. |
| 16. Machine Reset    | Resets the machine back to its factory default settings   |
| 17. Total Cycles     | Displays the total number of cycles the machine has carried out. This timer is not resettable.                                    |
| 18. Used Time        | Displays the total number of hours the machine has been used. This timer is not resettable.                                       |
| 19. Machine Copy     | Copies machine settings from one machine to another.  |
| 20. RS232 Port       | Sets if the RS232 port is to work with a barcode scanner or be used for external machine control.                                 |
| 21. Pressure Unit    | Sets the pressure unit displayed on the machine.  |
| 22. Vacuum Unit      | Sets the vacuum unit displayed on the machine.  |
| 23. Dispense Cancel  | Allows the user to set if the dispense cycle can be cancelled before the end of the dispense cycle is reached.                    |
| 24. Change Password  | Changes the password used to lock or unlock the machine controls and function menu.   |
| 25. Operator Lockout | Locks or unlocks the machine controls and function menu.  |
|                      |   |





**Contact the professionals at Fiber Optic Center for a quote or to get more details.**

[focenter.com](http://focenter.com) • 508-992-6464 | (800) 473-4237 • [sales@focenter.com](mailto:sales@focenter.com)

23 Centre Street • New Bedford, MA 02740 USA

*Product data subject to change without notice.*



| <b>FUNCTION MENU</b>   |   |
|--|---|
| <b>1. Program Number</b>   |   |
| <p>This function allows the user to select the program number that the machine will operate in and the dispense time will be saved against. The user can select a program number between 1 and 16.</p> <div style="text-align: center; margin: 10px 0;">  </div> |   |
| <b>1.</b>  | <p>When the Program Number page is displayed, press the  button to enter into the setting page for the program number.</p>                              |
| <b>2.</b>  | <p>Press the  or  button to select the required program number.</p> |
| <b>3.</b>  | <p>Press the  button to exit the selected function setting.</p>  |

**Contact the professionals at Fiber Optic Center for a quote or to get more details.**

[focenter.com](http://focenter.com) • 508-992-6464 | (800) 473-4237 • [sales@focenter.com](mailto:sales@focenter.com)

23 Centre Street • New Bedford, MA 02740 USA







*Product data subject to change without notice.*

## FUNCTION MENU

### 2. Glue Alarm

This function allows the user to set a timer that will trigger a visual and audible alarm to indicate when the fluid material is either no longer useable, or its optimal working life has been reached. This functionality is particularly useful for sensitive (moisture, temperature, light, etc.) or multi-component materials which have strict pot-life or working life dispensing requirements.



|    |  |
|----|--|
| 1. | When the Glue Alarm page is displayed, press the  button to enter into the setting page for the Glue Alarm.   |
| 2. | There are two (2) adjustable parameters for this function: <u>MODE</u> , <u>Glue Time</u> . Press the  button to scroll through these parameters.                       |
| 3. | MODE: Use the  or  buttons to turn the Glue Alarm <u>MODE</u> On or Off.               |
| 4. | Time Left (TL): Displays the time left before the glue alarm is activated. The glue time (GT) can be reset back to the original set value by pressing the  button.        |
| 5. | Glue Time (GT): Use the  and  button to set the <u>Glue Time</u> value in minutes “m”. |





Contact the professionals at Fiber Optic Center for a quote or to get more details.

[focenter.com](http://focenter.com) • 508-992-6464 | (800) 473-4237 • [sales@focenter.com](mailto:sales@focenter.com)

23 Centre Street • New Bedford, MA 02740 USA

Product data subject to change without notice.



|    |   |
|----|---|
| 6. | <p>Press the  button to exit the selected function setting. The Glue Alarm Time will automatically start after exiting the Function menu back into the home screen.</p>                          |
| 7. | <p>A letter “G” will show on the home screen when this function is turned ON. The Glue Alarm time left (G) can be seen counting down when the Function display screen is selected.</p>          |
| 8. | <p>When the timer reaches zero (0), the text “G” will flash and a pop-up message “!Glue Alarm!” will be displayed on the screen. Pin #6 of the I/O output circuit will also be activated.</p>  |
| 9. | <p>The Glue Alarm Time is reset by pressing the  button or momentarily (two (2) seconds) activating pin #16 of the I/O input circuit.</p>  |

Contact the professionals at Fiber Optic Center for a quote or to get more details.

[focenter.com](http://focenter.com) • 508-992-6464 | (800) 473-4237 • [sales@focenter.com](mailto:sales@focenter.com)

23 Centre Street • New Bedford, MA 02740 USA







Product data subject to change without notice.

## FUNCTION MENU

### 3. Pressure Alarm

This function allows the user to set a pressure value threshold (as well as a corresponding percentage tolerance) that must be met in order for the machine to be actuated. A visual and audible alarm will trigger if the set regulated pressure is not within tolerance.



|    |   |
|----|---|
| 1. | When the Pressure Alarm page is displayed, press the  button to enter into the setting page for the Pressure Alarm.  |
| 2. | There are two (3) adjustable parameters for this function: <u>MODE</u> , <u>Pressure</u> , <u>Tolerance</u> . Press the  button to scroll through these parameters.  |
| 3. | <u>MODE</u> : Use the  or  buttons to turn the Pressure Alarm <u>MODE</u> On or Off.  |
| 4. | <u>Pressure</u> : Use the  or  buttons to set the required regulated <u>Pressure</u> value.<br><br>Or, press the  button to import the set regulated pressure value, displayed on the home screen. |

**Contact the professionals at Fiber Optic Center for a quote or to get more details.**







[focenter.com](http://focenter.com) • 508-992-6464 | (800) 473-4237 • [sales@focenter.com](mailto:sales@focenter.com)

23 Centre Street • New Bedford, MA 02740 USA

*Product data subject to change without notice.*



**DC100 MAX Digital Dispenser Operating Manual**

|    |   |
|----|---|
| 5. | <p><u>Tolerance</u>: Use the  or  buttons to set the <u>Tolerance</u>. When this tolerance is exceeded above or below the set pressure, then the Pressure Alarm will be activated.</p>  |
| 6. | <p>Press the  button to exit the selected function setting.</p>  |
| 7. | <p>A letter "P" will be displayed on the home screen when this function is turned ON.</p>   |
| 8. | <p>Whenever the regulated pressure is outside of the set tolerance, the letter "P" will flash and it will not be possible to actuate the machine. Pin #6 of the I/O output circuit will also be activated.</p> <p>If the machine is actuated when the Pressure Alarm is activated, a pop-up message "!Pressure Alarm!" will be displayed on the screen and an audible noise heard.</p>  |
| 9. | <p>The pop-up message "!Pressure Alarm!" is removed by pressing the  button or momentarily (two (2) seconds) activating pin #16 of the I/O input circuit.</p> <p>Check the MAIN AIR IN pressure and/or adjust the pressure regulator on the front of the machine as needed.</p>  |

**Contact the professionals at Fiber Optic Center for a quote or to get more details.**

[focenter.com](http://focenter.com) • 508-992-6464 | (800) 473-4237 • [sales@focenter.com](mailto:sales@focenter.com)

23 Centre Street • New Bedford, MA 02740 USA

*Product data subject to change without notice.*









## FUNCTION MENU

### 4. Vacuum Alarm

This function allows the user to set a vacuum value threshold (as well as a corresponding percentage tolerance) that must be met in order for the machine to be actuated. A visual and audible alarm will trigger if the vacuum is not within tolerance.



|    |  |
|----|--|
| 1. | When the Vacuum Alarm page is displayed, press the  button to enter into the setting page for the Vacuum Alarm.   |
| 2. | There are two (3) adjustable parameters for this function: <u>MODE</u> , <u>Vacuum</u> , <u>Tolerance</u> . Press the  button to scroll through these parameters.   |
| 3. | <p><u>MODE</u>: Use the  or  buttons to turn the Vacuum Alarm <u>MODE</u> On or Off.</p> <p>Or, press the  button to import the set regulated pressure value, displayed on the home screen.</p> |
| 4. | <u>Vacuum</u> : Use the  or  buttons to set the required <u>Vacuum</u> value.  |

Contact the professionals at Fiber Optic Center for a quote or to get more details.







[focenter.com](http://focenter.com) • 508-992-6464 | (800) 473-4237 • [sales@focenter.com](mailto:sales@focenter.com)

23 Centre Street • New Bedford, MA 02740 USA

Product data subject to change without notice.



DC100 MAX Digital Dispenser Operating Manual

|    |   |
|----|---|
| 5. | <p>Tolerance: Use the  or  buttons to set the <u>Tolerance</u>. When this tolerance is exceeded above or below the set vacuum, then the Vacuum Alarm will be activated.</p>   |
| 6. | <p>Press the  button to exit the selected function setting.</p>  |
| 7. | <p>A letter “V” will be displayed on the home screen when this function is turned ON.</p>   |
| 8. | <p>Whenever the vacuum is outside of the set tolerance, the letter “V” will flash and it will not be possible to actuate the machine. Pin #6 of the I/O output circuit will also be activated.</p> <p>If the machine is actuated when the Vacuum Alarm is activated, a pop-up message “!Vacuum Alarm!” will be displayed on the screen and an audible noise heard.</p>  |
| 9. | <p>The pop-up message “!Vacuum Alarm!” is removed by pressing the  button or momentarily (two (2) seconds) activating pin #16 of the I/O input circuit.</p> <p>Adjust the vacuum control knob on the front of the machine as needed.</p>   |

Contact the professionals at Fiber Optic Center for a quote or to get more details.

[focenter.com](http://focenter.com) • 508-992-6464 | (800) 473-4237 • [sales@focenter.com](mailto:sales@focenter.com)

23 Centre Street • New Bedford, MA 02740 USA









Product data subject to change without notice.

## FUNCTION MENU

### 5. Auto Purge



This function allows the user to set an automatic dispense time in pre-defined intervals when the machine is idle. This functionality is particularly useful for sensitive (moisture, temperature, light, etc.) or multi-component (2K) materials which have strict pot-life or working life dispensing requirements. This prevents premature curing of material in the mixing nozzle or dispense tip.



|    |   |
|----|---|
| 1. | When the Auto Purge page is displayed, press the  button to enter into the setting page for the Auto Purge.  |
| 2. | There are two (3) adjustable parameters for this function: <u>MODE</u> , <u>Delay Time</u> , <u>Dispense Time</u> . Press the  button to scroll through these parameters.                      |
| 3. | <u>MODE</u> : Use the  or  buttons to turn the Auto Purge <u>MODE</u> On or Off.                            |
| 4. | <u>Delay Time</u> : Use the  or  buttons to set the required <u>Delay Time</u> value in minutes (m).        |
| 5. | <u>Dispense Time</u> : Use the  and  buttons to set the required <u>Dispense Time</u> value in seconds (s). |

**Contact the professionals at Fiber Optic Center for a quote or to get more details.**



|    |   |
|----|---|
| 6. | <p>Press the  button to exit the selected function setting.</p>  |
| 7. | <p>A letter "A" will be displayed on the home screen when this function is turned ON.</p>  <p>The Auto Purge Delay Time and Dispense Time can be seen counting down when the Function display screen is selected.</p>   |
| 8. | <p>The Auto Purge Delay Time will begin counting down to zero (0) after the machine has been actuated for the first time after exiting the function menu.</p> <p>When the timer reaches zero (0), the machine will automatically actuate for the time set in the Auto Purge Dispense Time parameter.</p> <p>A letter "A" will flash on the home screen during the actuation of the Auto Purge Dispense Time .</p> <p>If the machine is actuated before the timer reaches zero (0), then the machine will reset back to the time set in the Auto Purge Delay Time parameter and begin automatically counting down to zero (0), after the completion of the dispense cycle.</p> |
| 9. | <p>The Auto Purge can be reset at any time by pressing the  button or momentarily (two (2) seconds) activating pin #16 of the I/O input circuit.</p>  |
|    |   |

Contact the professionals at Fiber Optic Center for a quote or to get more details.

[focenter.com](http://focenter.com) • 508-992-6464 | (800) 473-4237 • [sales@focenter.com](mailto:sales@focenter.com)

23 Centre Street • New Bedford, MA 02740 USA

Product data subject to change without notice.







## FUNCTION MENU

### 6. Add Time+

This function allows the user to add a cumulative time offset to the original timed shot at any time by pressing the  button. This function can be useful to control the dispensed material amount as the barrel or cartridge empties over time or when dispensing multi-component (2K) materials which are curing or increasing in viscosity over time.

This function is used in conjunction when the machine is set and used in Time+ mode.



|    |   |
|----|---|
| 1. | When the Add Time+ page is displayed, press the  button to enter into the setting page for the Add Time+.  |
| 2. | Use the  or  buttons to set the time value in seconds (s) that will be added to the saved dispense time value when the  button is pressed. |
| 3. | Press the  button to exit the selected function setting.   |
| 4. | The cumulative time added to the saved time value when using the machine in Time+ mode can be deleted by pressing the  button or momentarily (two (2) seconds) activating pin #16 of the I/O input circuit.  |

**Contact the professionals at Fiber Optic Center for a quote or to get more details.**

[focenter.com](http://focenter.com) • 508-992-6464 | (800) 473-4237 • [sales@focenter.com](mailto:sales@focenter.com)

23 Centre Street • New Bedford, MA 02740 USA







## FUNCTION MENU

### 7. Cycle Delay

This function allows the user to set a delay time in between one dispense cycle ending and the next dispense cycle automatically starting.

This function is used in conjunction when the machine is set and used in Cycle mode.



1. When the Cycle Delay page is displayed, press the  button to enter into the setting page for the Cycle Delay.
2. Use the  or  buttons to set the time value in seconds (s) that will be used as the Delay Time in between dispense cycles.
3. Press the  button to exit the selected function setting.

**Contact the professionals at Fiber Optic Center for a quote or to get more details.**

[focenter.com](http://focenter.com) • 508-992-6464 | (800) 473-4237 • [sales@focenter.com](mailto:sales@focenter.com)

23 Centre Street • New Bedford, MA 02740 USA

*Product data subject to change without notice.*



## FUNCTION MENU

### 8. Dispense Count

This function displays the total number of completed cycles made by the machine. Every dispensing signal from all modes is accumulated to the Dispense Count counter.

The counter is resettable.



- |    |  |
|----|--|
| 1. | When the Dispense Count page is displayed, press the  button to enter into the setting page for the Dispense Count. |
| 2. | Press and hold the  button for 3 seconds to reset the Dispense Counter to zero (0).                                 |
| 3. | After the dispense counter has been reset, the machine will automatically return back to the function menu.  |

**Contact the professionals at Fiber Optic Center for a quote or to get more details.**

[focenter.com](http://focenter.com) • 508-992-6464 | (800) 473-4237 • [sales@focenter.com](mailto:sales@focenter.com)

23 Centre Street • New Bedford, MA 02740 USA

*Product data subject to change without notice.*







## FUNCTION MENU

### 9. Dispense Limit

This function allows the user to set the total number of dispense cycles that the machine is able to complete. A visual alarm will trigger once the Dispense Limit has been reached preventing the machine from being actuated further until the Dispense Limit has been reset.



|    |   |
|----|---|
| 1. | When the Dispense Limit page is displayed, press the  button to enter into the setting page for the Dispense Limit.  |
| 2. | Use the  or  buttons to set the total number of dispense cycles that the machine is able to complete before the "Limit Alarm" message is activated.             |
| 3. | Press the  button to exit the selected function setting.   |
| 4. | <p>A letter "L" will be displayed on the home screen when this function is turned ON.</p>  <p>The remaining dispense cycles (L) before the Dispense Limit is reached, can be seen counting down when the Function display screen is selected.</p> |

Contact the professionals at Fiber Optic Center for a quote or to get more details.

[focenter.com](http://focenter.com) • 508-992-6464 | (800) 473-4237 • [sales@focenter.com](mailto:sales@focenter.com)

23 Centre Street • New Bedford, MA 02740 USA



***DC100 MAX Digital Dispenser Operating Manual***



|    |  |
|----|--|
| 5. | When the Dispense Limit value is reached a pop-up message “!Limit Alarm!” will be displayed on the screen. Pin #6 of the I/O output circuit will also be activated.  |
| 6. | The Dispense Limit is reset by pressing the  button or momentarily (two (2) seconds) activating pin #16 of the I/O input circuit. |
|    |  |

**Contact the professionals at Fiber Optic Center for a quote or to get more details.**

[focenter.com](http://focenter.com) • 508-992-6464 | (800) 473-4237 • [sales@focenter.com](mailto:sales@focenter.com)

23 Centre Street • New Bedford, MA 02740 USA

*Product data subject to change without notice.*



| FUNCTION MENU  |  |
|--|--|
| 10. Dispense Time  |  |
| <p>This function displays the total number of minutes of dispensing made by the machine. Every dispensing time from all modes is accumulated to the Dispense Time timer regardless of whether the full timed shot was completed.</p> <p>The time is resettable.</p> <div style="text-align: center;"> </div> |  |
| 1.   | <p>When the Dispense Time page is displayed, press the  button to enter into the setting page for the Dispense Time.</p> |
| 2.   | <p>Press and hold the  button for 3 seconds to reset the Dispense Time timer to zero (0).</p>                            |
| 3.   | <p>After the Dispense Time timer has been reset, the machine will automatically return back to the function menu.</p>    |
|  |  |

**Contact the professionals at Fiber Optic Center for a quote or to get more details.**

[focenter.com](http://focenter.com) • 508-992-6464 | (800) 473-4237 • [sales@focenter.com](mailto:sales@focenter.com)

23 Centre Street • New Bedford, MA 02740 USA

*Product data subject to change without notice.*

## FUNCTION MENU





### 11. Sequence

This function allows the user to create and run a sequence of programs one after the other. The user is able to control when the machine changes from one program to another by either shot count or time.

This function is particularly useful when dispensing multi-component (2K) materials which have strict pot-life or working life dispense requirements.

This allows the machine to maintain a consistent shot size / dispense volume by increasing the dispense time as the material is increasing in viscosity.











|    |   |
|----|---|
| 1. | When the Sequence page is displayed, press the  button to enter into the setting page for the Sequence.  |
| 2. | There are six (6) adjustable parameters for this function: <u>MODE</u> , <u>Program Change</u> , <u>Shot</u> , <u>Time</u> , <u>Start</u> , <u>End</u> . Press the  button to scroll through these parameters. |
| 3. | <u>MODE</u> : Use the  or  buttons to turn the Sequence <u>MODE</u> On or Off.  |

Contact the professionals at Fiber Optic Center for a quote or to get more details.

[focenter.com](http://focenter.com) • 508-992-6464 | (800) 473-4237 • [sales@focenter.com](mailto:sales@focenter.com)

23 Centre Street • New Bedford, MA 02740 USA

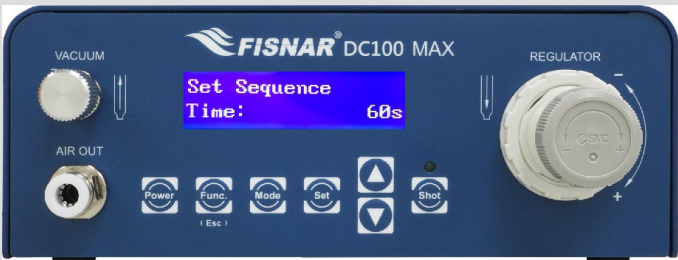

|    |  |
|----|--|
| 4. | <p><b>Program Change:</b> Use the  or  buttons to select if the machine will change from one program number to the next by shot count (SHOT) or by time (TIME).</p>    |
| 5. | <p><b>Shot:</b> If the program number is to change from one program number to the next by shot count, use the  or  buttons to set the number of shots (n) that each program will cycle for, before changing to the next program number.</p>             |
| 6. | <p><b>Time:</b> If the program number is to change from one program number to the next by time, use the  or  buttons to set the duration of time in seconds (s) that each program will remain in, before changing to the next program number.</p>  |

Contact the professionals at Fiber Optic Center for a quote or to get more details.









[focenter.com](http://focenter.com) • 508-992-6464 | (800) 473-4237 • [sales@focenter.com](mailto:sales@focenter.com)

23 Centre Street • New Bedford, MA 02740 USA

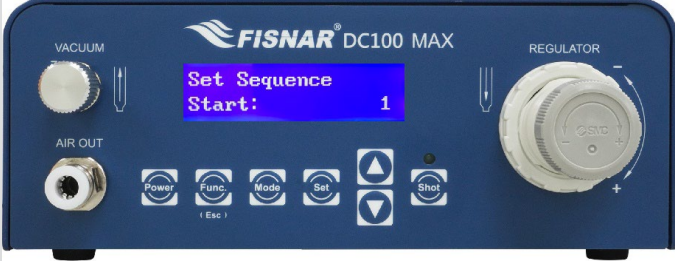
Product data subject to change without notice.

**DC100 MAX Digital Dispenser Operating Manual**



|    |   |
|----|---|
| 7. | <p><u>Start:</u> Use the  or  buttons to set the Program number that the sequence will start from.</p>    |
| 8. | <p><u>End:</u> Use the  or  buttons to set the Program number that the sequence will end at.</p>   |
| 9. | <p>Press the  button to exit the selected function setting. After exiting the Function Menu back into the home screen the machine will automatically change to TIMED mode and to the program number selected in the Start parameter.</p> <p>If the user has set to change the program number by time, then the machine will also automatically start counting down after exiting the Function menu back into the home screen.</p>  |



**Contact the professionals at Fiber Optic Center for a quote or to get more details.**

[focenter.com](http://focenter.com) • 508-992-6464 | (800) 473-4237 • [sales@focenter.com](mailto:sales@focenter.com)

23 Centre Street • New Bedford, MA 02740 USA

*Product data subject to change without notice.*

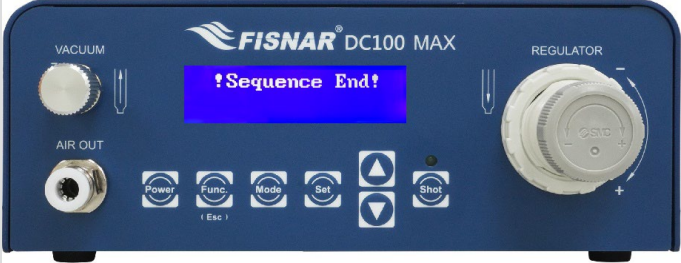

|     |   |
|-----|---|
| 10. | <p>When the sequence has executed through to the completion of the program number selected in the End parameter, a pop-up message “!Sequence End!” will be displayed on the screen.</p>  <p>It will not be possible to actuate the machine further until it has been reset.</p>   |
| 11. | <p>The Sequence is reset back to the program number selected in the Start parameter by pressing the  button or momentarily (two (2) seconds) activating pin #16 of the I/O input circuit.</p> <p>If the machine is reset whilst in the middle of carrying out a sequence, it will reset back to the program number selected in the Start parameter</p> |
|     |   |

**Contact the professionals at Fiber Optic Center for a quote or to get more details.**

[focenter.com](http://focenter.com) • 508-992-6464 | (800) 473-4237 • [sales@focenter.com](mailto:sales@focenter.com)

23 Centre Street • New Bedford, MA 02740 USA

*Product data subject to change without notice.*

## FUNCTION MENU





### 12. Shot Actuation

This function allows the user to set if the dispense actuation signal will work as a momentary or latching type when the machine is set to PURGE mode.

Momentary (Default) = The machine will actuate for as long as the dispense actuation signal is received. When the dispense actuation signal is not received the machine will stop actuating.

Latching = The machine will actuate for as long as the dispense actuation signal is received. When the dispense actuation signal is not received the machine will continue to actuate. When the next dispense actuation signal is received the machine will stop actuating.



1. When the Shot Actuation page is displayed, press the  button to enter into the setting page for the Shot Actuation.
2. Use the  or  buttons to set the shot actuation type,
3. Press the  button to exit the selected function setting.

**Contact the professionals at Fiber Optic Center for a quote or to get more details.**

[focenter.com](http://focenter.com) • 508-992-6464 | (800) 473-4237 • [sales@focenter.com](mailto:sales@focenter.com)

23 Centre Street • New Bedford, MA 02740 USA



## FUNCTION MENU

### 13. Power Button



This function allows for the machine to be turned on immediately when power is applied, instead of pushing the power button on the machine. This can be helpful when the machine is being used as part of a larger system that has a main power switch, allowing for the machine to start up and be ready for use when the main power is turned onto the system.

Enabled = The machine is turned on using the power button on the machine.

Disabled = The machine is turned on immediately when power is applied.



1. When the Power Button page is displayed, press the  button to enter into the setting page for the Power Button.

2. Use the  or  buttons to set if the power button is enabled or disabled

3. Press the  button to exit the selected function setting.

**Contact the professionals at Fiber Optic Center for a quote or to get more details.**

[focenter.com](http://focenter.com) • 508-992-6464 | (800) 473-4237 • [sales@focenter.com](mailto:sales@focenter.com)

23 Centre Street • New Bedford, MA 02740 USA







## FUNCTION MENU

### 14. Language

This function allows the user to select the language that will be displayed on the screen. The user can select English, Mandarin Chinese, French, Spanish or German



- |    |  |
|----|--|
| 1. | When the Language page is displayed, press the  button to enter into the setting page for the Language.                               |
| 2. | Use the  or  buttons to set the required language. |
| 3. | Press the  button to exit the selected function setting.  |

**Contact the professionals at Fiber Optic Center for a quote or to get more details.**

[focenter.com](http://focenter.com) • 508-992-6464 | (800) 473-4237 • [sales@focenter.com](mailto:sales@focenter.com)

23 Centre Street • New Bedford, MA 02740 USA





## FUNCTION MENU

### 15. Calibration

This function allows the user to calibrate the digital pressure and vacuum gauge to the atmospheric and environmental conditions where the machine is being used.



- |    |  |
|----|--|
| 1. | When the Calibration page is displayed, press the  button to enter into the setting page for the Calibration.                                |
| 2. | Follow the prompt on the screen to confirm that the Main Air In hose has been removed from the back of the machine by pressing the  button. |
| 3. | Press and hold the  button for 3 seconds to calibrate the pressure and vacuum gauge on the machine.   |
| 4. | After the pressure and vacuum gauge has been calibrated, the machine will automatically return back to the function menu.  |

**Contact the professionals at Fiber Optic Center for a quote or to get more details.**

[focenter.com](http://focenter.com) • 508-992-6464 | (800) 473-4237 • [sales@focenter.com](mailto:sales@focenter.com)



23 Centre Street • New Bedford, MA 02740 USA

## FUNCTION MENU

### 16. Machine Reset

This function allows the user to reset the machine back to its factory default settings.



- |    |   |
|----|---|
| 1. | When the Machine Reset page is displayed, press the  button to enter into the setting page for the Machine Reset. |
| 2. | Press and hold the  button for 10 seconds to reset the machine back to its factory default settings.             |
| 3. | After the Machine has been reset, the machine will automatically switch off.  |

**Contact the professionals at Fiber Optic Center for a quote or to get more details.**

[focenter.com](http://focenter.com) • 508-992-6464 | (800) 473-4237 • [sales@focenter.com](mailto:sales@focenter.com)

23 Centre Street • New Bedford, MA 02740 USA

*Product data subject to change without notice.*



## FUNCTION MENU

### 17. Total Cycles

This function displays the total number of completed cycles made by the machine. Every dispensing signal from all modes is accumulated to the Dispense Count counter.

The counter is not resettable.

It is not possible to access this function setting.



**Contact the professionals at Fiber Optic Center for a quote or to get more details.**

[focenter.com](http://focenter.com) • 508-992-6464 | (800) 473-4237 • [sales@focenter.com](mailto:sales@focenter.com)

23 Centre Street • New Bedford, MA 02740 USA

*Product data subject to change without notice.*

## FUNCTION MENU

### 18. Used Time

This function displays the cumulative lifetime hours that the machine has been powered on for. The timer starts counting as soon as the machine is turned ON.

The timer is not resettable.

It is not possible to access this function setting.



**Contact the professionals at Fiber Optic Center for a quote or to get more details.**

[focenter.com](http://focenter.com) • 508-992-6464 | (800) 473-4237 • [sales@focenter.com](mailto:sales@focenter.com)

23 Centre Street • New Bedford, MA 02740 USA

*Product data subject to change without notice.*



| FUNCTION MENU  |  |
|--|--|
| 19. Machine Copy   |  |
| <p>This function allows the user to copy all stored programs, settings, and parameters from one machine to another. (The receiving machines programs, settings, and parameters will be overwritten)</p> <p>The function can only be used by the machine containing the stored programs, settings, and parameters that you want to transfer onto another machine.</p> |  |
|  |  |
| 1.   | Install a straight parallel RS232 communication cable between the RS232 port on the back of the two machines.  |
| 2.   | When the Machine Copy page is displayed, press the  button to enter into the setting page for the Machine Copy.  |
| 3.   | Follow the prompt on the screen to confirm that an RS232 cable has been connected between the machine being controlled and the machine that the settings and parameters are to be copied onto by pressing the  button. |
| 4.   | Ensure that the machine that the settings and parameters are to be copied onto is powered on and displaying the home screen.   |
| 5.   | Press and hold the  button for 3 seconds to copy the setting and parameters from one machine to another.   |
| 6.   | A message will appear on both machines to confirm the settings and parameters have been successfully copied, and then automatically return back to the home screen.  |

**Contact the professionals at Fiber Optic Center for a quote or to get more details.**

[focenter.com](http://focenter.com) • 508-992-6464 | (800) 473-4237 • [sales@focenter.com](mailto:sales@focenter.com)

23 Centre Street • New Bedford, MA 02740 USA





*Product data subject to change without notice.*

## FUNCTION MENU

### 20. RS232 Port

This function allows the user to set if the RS232 Port on the back of the machine is to be setup to allow a barcode scanner to be connected to the machine or to allow the machine to be programmed and controlled remotely using MODBUS communication protocol.



1. When the RS232 Port page is displayed, press the  button to enter into the setting page for the RS232 Port.
2. Use the  or  buttons to set the configuration of the RS232 Port.
3. Press the  button to exit the selected function setting.

**Contact the professionals at Fiber Optic Center for a quote or to get more details.**

[focenter.com](http://focenter.com) • 508-992-6464 | (800) 473-4237 • [sales@focenter.com](mailto:sales@focenter.com)

23 Centre Street • New Bedford, MA 02740 USA

*Product data subject to change without notice.*







## FUNCTION MENU

### 21. Pressure Unit

This function allows the user to select the pressure units of measurement that will be displayed on the screen. The user can select psi, bar or kPa.



- |    |  |
|----|--|
| 1. | When the Pressure Unit page is displayed, press the  button to enter into the setting page for the Pressure Unit.   |
| 2. | Use the  or  buttons to set the required pressure unit of measurement. |
| 3. | Press the  button to exit the selected function setting.  |

**Contact the professionals at Fiber Optic Center for a quote or to get more details.**







## FUNCTION MENU

### 22. Vacuum Unit

This function allows the user to select the vacuum units of measurement that will be displayed on the screen. The user can select inHg, inH2o, or kPa.



- |    |  |
|----|--|
| 1. | When the Vacuum Unit page is displayed, press the  button to enter into the setting page for the Vacuum Unit.   |
| 2. | Use the  or  buttons to set the required vacuum unit of measurement. |
| 3. | Press the  button to exit the selected function setting.  |

**Contact the professionals at Fiber Optic Center for a quote or to get more details.**

[focenter.com](http://focenter.com) • 508-992-6464 | (800) 473-4237 • [sales@focenter.com](mailto:sales@focenter.com)

23 Centre Street • New Bedford, MA 02740 USA



## FUNCTION MENU

### 23. Dispense Cancel





This function allows the user to set if the dispense cycle can be cancelled before the end of the dispense cycle is reached.

This can be useful when the machine is being operated in TIME mode and there is a risk that the foot pedal switch may be accidentally pressed.

Enabled = The dispense cycle can be cancelled by sending another dispense actuation signal before the end of the dispense cycle is reached.

Disabled = The dispense cycle cannot be cancelled.



- |    |   |
|----|---|
| 1. | When the Dispense Cancel page is displayed, press the  button to enter into the setting page for the Dispense Cancel.                                      |
| 2. | Use the  or  buttons to enable or disable the Dispense Cancel function. |
| 3. | Press the  button to exit the selected function setting.   |

**Contact the professionals at Fiber Optic Center for a quote or to get more details.**

[focenter.com](http://focenter.com) • 508-992-6464 | (800) 473-4237 • [sales@focenter.com](mailto:sales@focenter.com)

23 Centre Street • New Bedford, MA 02740 USA









*Product data subject to change without notice.*

## FUNCTION MENU

### 24. Change Password

This function allows the user to change the password that is used to enter into the function menu when the Operator Lockout function is activated.



|    |   |
|----|---|
| 1. | When the Change Password page is displayed, press the  button to enter into the setting page for the Change Password.   |
| 2. | Use the  ,  and  buttons to enter the current password (1111).<br>If the password is forgotten a master password (1985) can be entered, to reset a new password. |
| 3. | Press and hold the  button for two seconds.  |
| 4. | Use the  ,  and  buttons to enter the new password.  |
| 5. | Press and hold the  button for three seconds. The machine will then automatically exit back to the function menu.  |

**Contact the professionals at Fiber Optic Center for a quote or to get more details.**

[focenter.com](http://focenter.com) • 508-992-6464 | (800) 473-4237 • [sales@focenter.com](mailto:sales@focenter.com)



23 Centre Street • New Bedford, MA 02740 USA

*Product data subject to change without notice.*







## FUNCTION MENU

### 25. Operator Lockout

This function allows the user to prevent the operator from making an adjustment to the machine settings or parameters. When activated, the  and  button are disabled and access to the Function Menu is password protected



|    |   |
|----|---|
| 1. | When the Operator Lockout page is displayed, press the  button to enter into the setting page for the Operator Lockout.                                   |
| 2. | Use the  or  buttons to switch ON or OFF the Operator Lockout function. |
| 3. | Press the  button to exit the selected function setting.   |
| 4. | To confirm if the Operator Lockout has been activated on the machine, refer to padlock symbol on the home screen.<br>Padlock in locked state = Operator Lockout ON<br>Padlock in unlocked state = Operator Lockout OFF                        |

Contact the professionals at Fiber Optic Center for a quote or to get more details.

[focenter.com](http://focenter.com) • 508-992-6464 | (800) 473-4237 • [sales@focenter.com](mailto:sales@focenter.com)

23 Centre Street • New Bedford, MA 02740 USA

Product data subject to change without notice.

## FOOT SWITCH CONNECTOR

| <u>Pin #</u> | <u>Description</u>        |
|--------------|---------------------------|
| 1            | <i>NO (Normally Open)</i> |
| 2            | <i>COM (Common)</i>       |
| 3            | <i>Not Used</i>           |

**External Machine Actuation**

|              |   |
|--------------|---|
| <b>Input</b> | A dry contact closure (0 Volt) between the Input (Pin #1) and Common (Pin #2) pins will trigger a dispense signal.  |
|              | <p><b>PLEASE READ:</b></p> <p>Do not apply a voltage between the input pin (1) and the common pin (2). Doing so will damage the control board and void all warranty conditions.</p> |

**Contact the professionals at Fiber Optic Center for a quote or to get more details.**

[focenter.com](http://focenter.com) • 508-992-6464 | (800) 473-4237 • [sales@focenter.com](mailto:sales@focenter.com)

23 Centre Street • New Bedford, MA 02740 USA

*Product data subject to change without notice.*



## I/O CONNECTOR

### Schematic



| Pin # | Function                      | Pin # | Function              |
|-------|-------------------------------|-------|-----------------------|
| 1     | 24V+ Internal Power OUT       | 14    | Machine Ready OUT     |
| 2     | Internal Ground (GND)         | 15    | Internal Ground (GND) |
| 3     | Contact Closure Initialize IN | 16    | Clear/Reset IN        |
| 4     | Alarm IN                      | 17    | Internal Ground (GND) |
| 5     | Internal Ground (GND)         | 18    | Bit 0 IN              |
| 6     | Alarm OUT                     | 19    | Bit 1 IN              |
| 7     | Internal Ground (GND)         | 20    | Bit 2 IN              |
| 8     | Start Signal IN 24V+          | 21    | Bit 3 IN              |
| 9     | Start IN GND (0V)             | 22    | Not Used              |
| 10    | Machine Busy OUT              | 23    | Not Used              |
| 11    | Internal Ground (GND)         | 24    | Not Used              |
| 12    | End of Cycle OUT              | 25    | Program Select IN     |
| 13    | Internal Ground (GND)         |       |                       |

Contact the professionals at Fiber Optic Center for a quote or to get more details.

[focenter.com](http://focenter.com) • 508-992-6464 | (800) 473-4237 • [sales@focenter.com](mailto:sales@focenter.com)

23 Centre Street • New Bedford, MA 02740 USA

Product data subject to change without notice.

## Output Signals

**Output Type:** Open Collector Photocoupler (NPN)

**Output Power:** Output signals are able to sink a maximum of 200 milliamps per pin.

**Output Function:** When the output signal is activated, the circuit between the output pin (pin #6, 10, 12 & 14) and the GND (pin #2, 5, 7, 11, 13, 15 & 17) is completed.

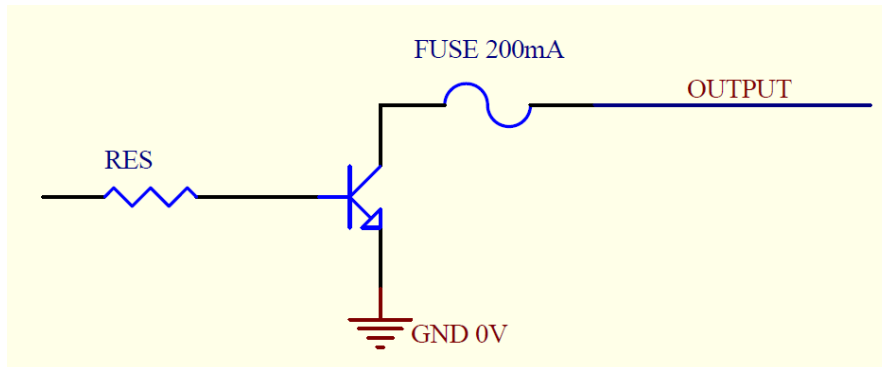

Example of I/O output port driving



**PLEASE READ:** If an inductive load (such as a relay) is connected to an output signal, be sure to install a diode as shown to prevent damage to the output photocoupler.

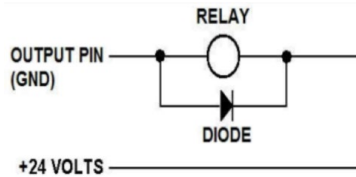

Installation of Diode

Contact the professionals at Fiber Optic Center for a quote or to get more details.

[focenter.com](http://focenter.com) • 508-992-6464 | (800) 473-4237 • [sales@focenter.com](mailto:sales@focenter.com)

23 Centre Street • New Bedford, MA 02740 USA

Product data subject to change without notice.



## Input Signals

**Input Type:** Photocoupler

**Input Power:** Pin #3, 4, 16, 18, 19, 20, 21 and #25 are an externally driven dry-contact voltage free contact closure circuit (I.E. Switch or Relay).

**Input Function (pin #3, 4, 16, 18, 19, 20, 21 and #25):**

To activate an input signal, pull the input pin (pin #3, 4, 16, 18, 19, 20, 21 or #25) down to a GND pin (pin #2, 5, 7, 11, 13, 15 & 17). Input signals utilize the machine internal power supply.

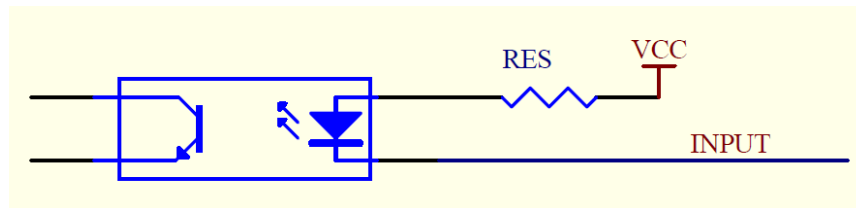

**Example of I/O input port driving**

**PLEASE READ:**



A dry contact closure between inputs (pin #3 or pin #4) and any ground will trigger an input signal. DO NOT apply a voltage to input pin #3 or pin #4 and ground. Doing so will damage the internal control board and void all warranty conditions.

**Input Function (pin #8):**

To actuate the machine from an external device using a voltage signal (24V+),

- connect input pin "Start Signal IN 24V+" (pin #8) to an external power supply (24V+)
- connect input pin "Start IN GND (0V)" (pin #9) to an external ground (0V)

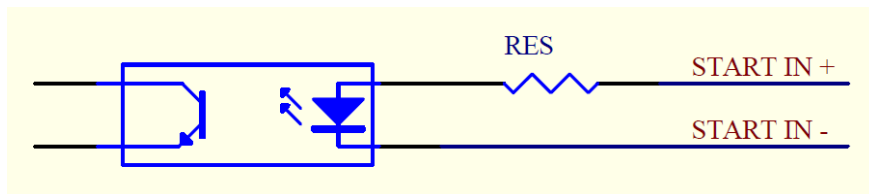

**Example of I/O input port driving (pin #8)**

Contact the professionals at Fiber Optic Center for a quote or to get more details.



## Output Signal Definition

### Pin #6 Alarm Out (Output):

- The signal will be activated if any one of the below conditions occur.
  - o If the external “Alarm In” input circuit has been activated.
  - o If the “Glue Alarm” has been activated by reaching zero (0).
  - o If the “Pressure Alarm” has been activated due to the pressure being outside of the set tolerance.
  - o If the “Vacuum Alarm” has been activated due to the vacuum being outside of the set tolerance.
  - o If the “Dispense Count Limit” has reached the set limit value.
- A pop-up message will be displayed on the home screen of the machine confirming the reason why the “Alarm Out” signal has been activated.
- If the “Alarm Out” signal is activated during a program cycle, the program cycle will be automatically stopped.
- It will not be possible to actuate a new program cycle until the “Alarm Out” signal has been switched off and the machine reset by pressing the  button or momentarily (two (2) seconds) activating pin #16 of the I/O input circuit.

### Pin #10 Machine Busy (Output):

- When the machine is actuating a program cycle the signal will be activated.
- When the machine is in the function menu the signal will be activated.

### Pin #12 End of Cycle (Output):

- When the machine has completed a program cycle the signal will be momentarily activated for a period of approximately 10ms.

### Pin #14 Machine Ready (Output):

- After machine power on, the signal will be activated.
- The signal will automatically switch off if any of the below conditions occur.
  - o “Machine Busy” Output signal activated.
  - o “End of Cycle” Output signal activated.
  - o “Alarm Out” Output signal activated.
- The signal will be re-activated automatically when all of the above conditions do not occur.

Contact the professionals at Fiber Optic Center for a quote or to get more details.

[focenter.com](http://focenter.com) • 508-992-6464 | (800) 473-4237 • [sales@focenter.com](mailto:sales@focenter.com)

23 Centre Street • New Bedford, MA 02740 USA

Product data subject to change without notice.



## Input Signal Definition

### Pin #3 CC Initialize (Input):

- When connected to a GND pin the “CC Initialize” signal will be activated, resulting in the machine dispense cycle being actuated.
  - o When in “PURGE” or “TEACH” mode, the machine will continue to be actuated (i.e. Dispensing fluid) until “CC Initialize” signal is removed from the GND pin.
  - o When in “TIMED” or “TIME+” mode, the machine will continue to be actuated (i.e. Dispensing fluid) until the set dispense time on the machine has been reached.
  - o When in “CYCLE” mode, the machine will continue to be actuated (i.e. Dispensing fluid) in a looping cycle until “CC Initialize” signal is removed from the GND pin and then re-applied.



- A green LED light will light up above the  button on the front panel of the controller, to identify the machine is actuating a dispense cycle (i.e. Dispensing fluid).

### Pin #4 Alarm In (Input):

- When connected to a GND pin the “Alarm In” signal will be activated, resulting in the “Alarm Out” signal (Pin #6) being activated automatically.
- A pop-up message “Input Alarm” will also be displayed on the home screen
- It will not be possible to actuate a new dispense cycle until the “Alarm In” signal has been de-activated



and the machine reset by pressing the  button or momentarily (two (2) seconds) activating pin #16 of the I/O input circuit.

### Pin #8 Start Signal IN 24V+ (Input):

- When connected to an external 24V+ power supply, the “Start Signal IN 24V+” signal will be activated, resulting in the machine dispense cycle being actuated.
  - o When in “PURGE” or “TEACH” mode, the machine will continue to be actuated (i.e. Dispensing fluid) until “CC Initialize” signal is removed from the GND pin.
  - o When in “TIMED” or “TIME+” mode, the machine will continue to be actuated (i.e. Dispensing fluid) until the set dispense time on the machine has been reached.
  - o When in “CYCLE” mode, the machine will continue to be actuated (i.e. Dispensing fluid) in a looping cycle until “CC Initialize” signal is removed from the GND pin and then re-applied.



- A green LED light will light up above the  button on the front panel of the controller, to identify the machine is actuating a dispense cycle (i.e. Dispensing fluid).



**PLEASE READ: For the “Start Signal IN 24V+” signal to work correctly, “Start IN GND (0V)” (pin #9) must be connected to an external GND (0V)**

**Contact the professionals at Fiber Optic Center for a quote or to get more details.**



**Pin #16 Clear/Reset In (Input):**

- When momentarily (two (2) seconds) connected to a GND pin the “Clear/Reset In” signal will be activated, resulting in the machine being reset and/or error message being cleared.
- The machine will need to be reset after one or more of the following conditions have occurred.
  - Glue Alarm function activated
  - Pressure Alarm function activated
  - Vacuum Alarm function activated
  - Dispense Limit function activated
  - Alarm IN signal activated
  - End of Sequence completed

**Pin #18, 19, 20 and 21 Bit Status In (Input):**

- The status setting of pin #18 - #21 are used to create a binary value to set the program number that the machine will automatically change to when the “Program Select” pin #25 signal is activated.
- When connected to a GND pin the “Bit Status” signal will be activated, resulting in its status changing.
  - Activated = Bit Status High (1)
  - Not Activated = Bit Status Low (0)
- The below table can be referenced, to set the correct program number according to the Bit Status.

| Program Number | Pin #18 Bit Status 0 | Pin #19 Bit Status 1 | Pin #20 Bit Status 2 | Pin #21 Bit Status 3 |
|----------------|----------------------|----------------------|----------------------|----------------------|
| 1              | 0                    | 0                    | 0                    | 0                    |
| 2              | 1                    | 0                    | 0                    | 0                    |
| 3              | 0                    | 1                    | 0                    | 0                    |
| 4              | 1                    | 1                    | 0                    | 0                    |
| 5              | 0                    | 0                    | 1                    | 0                    |
| 6              | 1                    | 0                    | 0                    | 1                    |
| 7              | 0                    | 1                    | 1                    | 0                    |
| 8              | 1                    | 1                    | 1                    | 0                    |
| 9              | 0                    | 0                    | 0                    | 1                    |
| 10             | 1                    | 0                    | 0                    | 1                    |
| 11             | 0                    | 1                    | 0                    | 1                    |
| 12             | 1                    | 1                    | 0                    | 1                    |
| 13             | 0                    | 0                    | 1                    | 1                    |
| 14             | 1                    | 0                    | 1                    | 1                    |
| 15             | 0                    | 1                    | 1                    | 1                    |
| 16             | 1                    | 1                    | 1                    | 1                    |

**Pin #16 Program Select In (Input):**

- When momentarily connected to a GND pin, the “Program Select IN” signal will be activated, causing the machine program number being changed according to the Bit Status of pin #18-21.

**Contact the professionals at Fiber Optic Center for a quote or to get more details.**

[focenter.com](http://focenter.com) • 508-992-6464 | (800) 473-4237 • [sales@focenter.com](mailto:sales@focenter.com)

23 Centre Street • New Bedford, MA 02740 USA









*Product data subject to change without notice.*



## Input / Output Signal Testing

The machine can be configured into a “Test” mode in order to allow the user to test the input and output signals of the I/O connector, the foot switch connector and the keypad buttons on the front panel of the machine.



|    |  |
|----|--|
| 1. | Remove the electrical power cord from the back of the machine.   |
| 2. | Press and hold down the  button and then insert the electrical power cord into the back of the machine.   |
| 3. | Once the LCD display panel is illuminated and displaying a solid white color background release the  button.   |
| 4. | Press the  button to display the I/O Test Screen  |
| 5. | <p>The upper line of values on the display screen will change state (“0” to “1”) to confirm the keypad button is working correctly or the machine I/O output is working correctly or internal electrical relay is working correctly.</p> <ul style="list-style-type: none"> <li>- 1<sup>st</sup> digit = Press  button to test activate “Alarm Out” signal.</li> <li>- 2<sup>nd</sup> digit = Press  button to test activate “Machine Busy Out” signal.</li> <li>- 3<sup>rd</sup> digit = Press  button to test activate “End Of Cycle Out” signal.</li> <li>- 4<sup>th</sup> digit = Press  button to test activate “Machine Ready Out” signal.</li> <li>- 5<sup>th</sup> digit = Press  button to test activate “Internal Electrical Relay” signal</li> </ul> |

**Contact the professionals at Fiber Optic Center for a quote or to get more details.**

[focenter.com](http://focenter.com) • 508-992-6464 | (800) 473-4237 • [sales@focenter.com](mailto:sales@focenter.com)

23 Centre Street • New Bedford, MA 02740 USA



|                  |   |
|------------------|---|
| <p><b>6.</b></p> | <p>The lower line of values on the display screen will change state (“1” to “0” or “0” to “1”) to confirm the keypad button is working correctly or the machine I/O input is working correctly.</p> <p>The values displayed from left to right are confirmed below</p> <ul style="list-style-type: none"> <li>- 1<sup>st</sup> digit = Power button</li> <li>- 2<sup>nd</sup> digit = Func. button</li> <li>- 3<sup>rd</sup> digit = Mode button</li> <li>- 4<sup>th</sup> digit = Set button</li> <li>- 5<sup>th</sup> digit = Up Arrow button</li> <li>- 6<sup>th</sup> digit = Down Arrow button</li> <li>- 7<sup>th</sup> digit = Shot Button</li> <li>- 8<sup>th</sup> digit = Contact Closure Initialize IN</li> <li>- 9<sup>th</sup> digit = Alarm IN</li> <li>- 10<sup>th</sup> digit = Start Signal IN</li> <li>- 11<sup>th</sup> digit = Clear/Reset IN</li> <li>- 12<sup>th</sup> digit = Bit 0 IN</li> <li>- 13<sup>th</sup> digit = Bit 1 IN</li> <li>- 14<sup>th</sup> digit = Bit 2 IN</li> <li>- 15<sup>th</sup> digit = Bit 3 IN</li> <li>- 16<sup>th</sup> digit = Program Select IN</li> <li>- 17<sup>th</sup> digit = Foot Switch IN</li> </ul> |
| <p><b>7.</b></p> | <p>To exit the I/O Test Screen remove the electrical power cord from the back of the machine.</p>   |
| <p><b>8.</b></p> | <p>Reinsert the electrical power cord back the back of the machine and press the  button.</p>  |
|                  |   |

**Contact the professionals at Fiber Optic Center for a quote or to get more details.**

[focenter.com](http://focenter.com) • 508-992-6464 | (800) 473-4237 • [sales@focenter.com](mailto:sales@focenter.com)

23 Centre Street • New Bedford, MA 02740 USA

*Product data subject to change without notice.*



## RS232 CONNECTOR

### Barcode Scanner

A barcode scanner can be attached to the machine, allowing the user to change the program number on the machine and actuate a dispense cycle.

Keyence barcode scanner (HR-100) plus communication cable (HR-1C3RC) and a null modem adapter have been successfully tested with the machine.



Keyence HR-100

- |           |   |
|-----------|---|
| <b>1.</b> | Check the RS232 Port Function Setting in the function menu of the machine, to make sure that "BARCODE" has been selected.   |
| <b>2.</b> | Plug the Barcode Scanner into the RS232 port on the back of the machine, ensuring that a null modem adapter is fitted between the communication cable and RS232 connector port. |
| <b>3.</b> | Scan the appropriate barcode label (appendix 1) to change the program number on the machine and/or actuate a dispense cycle.  |

**Contact the professionals at Fiber Optic Center for a quote or to get more details.**

[focenter.com](http://focenter.com) • 508-992-6464 | (800) 473-4237 • [sales@focenter.com](mailto:sales@focenter.com)

23 Centre Street • New Bedford, MA 02740 USA

*Product data subject to change without notice.*



## RS232 External Control

An external connection can be made with the RS232 connector on the back of the machine, allowing the user to remotely program, adjust, monitor and operate the machine using RS232 MODBUS communication protocol.

A standard straight parallel RS232 communication cable is needed to create a successful connection.

### RS232 MODBUS communication

|    |  |
|----|--|
| 1. | Check the RS232 Port Function Setting in the function menu of the machine, to make sure that “MODBUS” has been selected.   |
| 2. | Establish a connection between the external device and RS232 port on the back of the machine, ensuring that a straight parallel RS232 communication cable has been used. |
| 3. | Refer to the programming table (appendix 2) for a list of commands that can be sent to the machine as a hexadecimal value.   |
|    |  |

**Contact the professionals at Fiber Optic Center for a quote or to get more details.**

[focenter.com](http://focenter.com) • 508-992-6464 | (800) 473-4237 • [sales@focenter.com](mailto:sales@focenter.com)

23 Centre Street • New Bedford, MA 02740 USA

*Product data subject to change without notice.*



## SPARE PARTS LIST

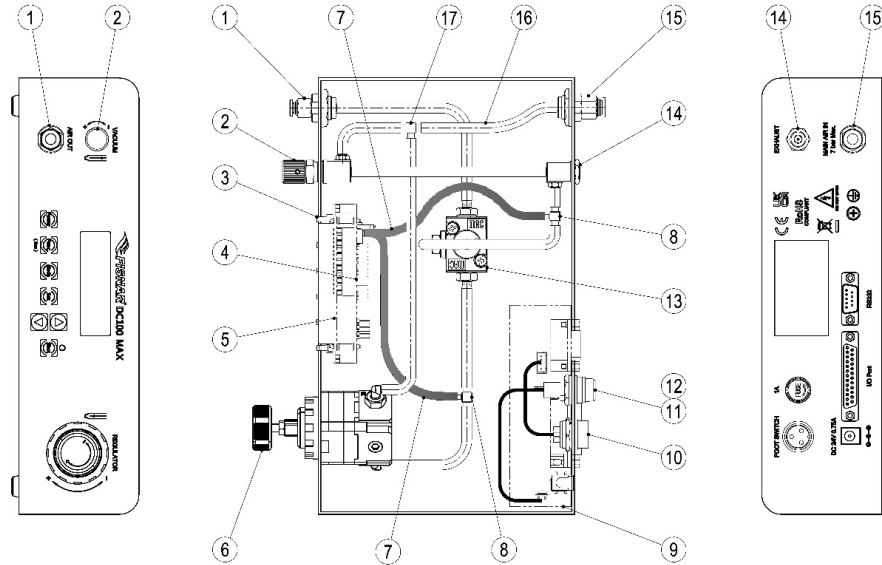

| Item | Part Number | Description   |
|------|-------------|---|
| 1    | 5601872     | Air Out Module  |
| 2    | 5601873     | Vaccum Throttle   |
| 3    | 5601974     | Button Patch Board  |
| 4    | 5601975     | Control Board   |
| 5    | 5601976     | LCD Display   |
| 6    | 5601891     | Pressure Regulating Valve                                 |
| 7    | 5601886     | Ø4mm Black PU Tubing                                      |
| 8    | 5601878     | T-Style Barb Joint  |
| 9    | 5601977     | Power Transfer Board                                      |
| 10   | 5601880     | Dispenser Connector Wire                                  |
| 11   | 5601881     | Fuse Wire   |
| 12   | 5601882     | Fuse  |
| 13   | 5601898     | Solenoid Module   |
| 14   | 5601884     | Vacuum Valve  |
| 15   | 5601885     | Air In Module   |
| 16   | 5601887     | Ø6mm Transparent PU Tubing                                |
| 17   | 5601894     | T-Style Barb Joint (6mm)                                  |
| 18*  | 5601890     | Power Adaptor (Input: 100 – 240 VAC / Output: 24 VDC)     |
| 19*  | 5601888     | Foot Pedal  |
| 20*  | 561851      | Air Inlet Hose Assembly                                   |
| 21*  | 5601969     | FSX Syringe Barrel Stand                                  |
| 22*  | 5779K712    | Push to Connect Tube Fitting 1/4" Stem OD X 5/32" Tube OD |

\*Item Not Shown

Contact the professionals at Fiber Optic Center for a quote or to get more details.

[focenter.com](http://focenter.com) • 508-992-6464 | (800) 473-4237 • [sales@focenter.com](mailto:sales@focenter.com)

23 Centre Street • New Bedford, MA 02740 USA

Product data subject to change without notice.



## SPARE PARTS LIST



5601969 - FSX Syringe Barrel Stand

| Ref. | Item Number | Description              |
|------|-------------|--------------------------|
| 1    | 5601970     | Purge Tray (50 per pack) |
| 2    | 5601971     | Bottle Kit (10 per pack) |

Contact the professionals at Fiber Optic Center for a quote or to get more details.

[focenter.com](http://focenter.com) • 508-992-6464 | (800) 473-4237 • [sales@focenter.com](mailto:sales@focenter.com)

23 Centre Street • New Bedford, MA 02740 USA

Product data subject to change without notice.



## TECHNICAL DRAWING

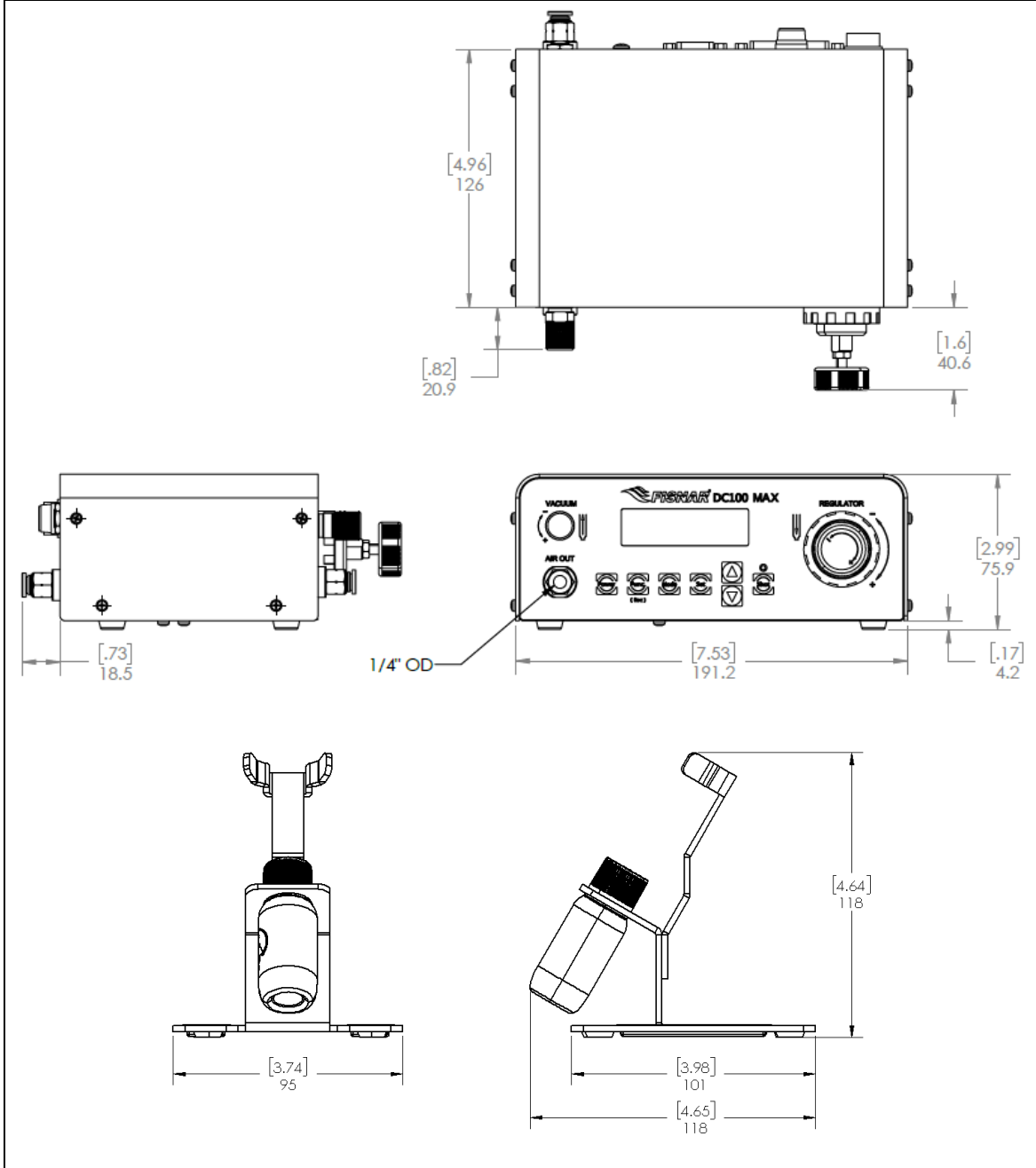

Contact the professionals at Fiber Optic Center for a quote or to get more details.

[focenter.com](http://focenter.com) • 508-992-6464 | (800) 473-4237 • [sales@focenter.com](mailto:sales@focenter.com)

23 Centre Street • New Bedford, MA 02740 USA

Product data subject to change without notice.

## APPENDIX 1



P16



P15



P14



P13



P12



P11



P10



P09



P08



P07



P06



P05



P04



P03



P02



P01



SHOT

**Contact the professionals at Fiber Optic Center for a quote or to get more details.**

[focenter.com](http://focenter.com) • 508-992-6464 | (800) 473-4237 • [sales@focenter.com](mailto:sales@focenter.com)

23 Centre Street • New Bedford, MA 02740 USA

*Product data subject to change without notice.*



## APPENDIX 2

| MODBUS RTU  |           |              |                 |                  |                      |                      |                      |                    |      |                    |      |                   |     |
|---|-----------|--------------|-----------------|------------------|----------------------|----------------------|----------------------|--------------------|------|--------------------|------|-------------------|-----|
| Transmitting speed rate settings:- 115200, n, 8, 1                        |           |              |                 |                  |                      |                      |                      |                    |      |                    |      |                   |     |
| Command Code (03H) Read Multiple Records/Parameters of Controller (1~100) |           |              |                 |                  |                      |                      |                      |                    |      |                    |      |                   |     |
| Write In  | 0         | 1            | 2               | 3                | 4                    | 5                    | 6                    | 7                  |      |                    |      |                   |     |
|   | Machine # | Command Code | Data Address    |                  | Data Record Quantity |                      | CRC-16 Checking Code |                    |      |                    |      |                   |     |
|   | 64 H      | 03 H         | 00 H            | 01 H             | 00 H                 | 01 H                 | CRC                  | CRC                |      |                    |      |                   |     |
| Feedback  | 1         | 2            | 3               | 4                | 5                    | 6                    | 7                    |                    |      |                    |      |                   |     |
|   | Machine # | Command Code | Data Record Qty | Data Information |                      | CRC-16 Checking Code |                      |                    |      |                    |      |                   |     |
|   | 64 H      | 03 H         | 02 H            | 00 H             | 00 H                 | CRC                  | CRC                  |                    |      |                    |      |                   |     |
| Command Code (06H) Write In Single Records/Parameters of Controller       |           |              |                 |                  |                      |                      |                      |                    |      |                    |      |                   |     |
| Write In  | 0         | 1            | 2               | 3                | 4                    | 5                    | 6                    | 7                  |      |                    |      |                   |     |
|   | Machine # | Command Code | Data Address    |                  | Data Information     |                      | CRC-16 Checking Code |                    |      |                    |      |                   |     |
|   | 64 H      | 06 H         | 00 H            | 01 H             | 00 H                 | 64 H                 | CRC                  | CRC                |      |                    |      |                   |     |
| Feedback  | 0         | 1            | 2               | 3                | 4                    | 5                    | 6                    | 7                  |      |                    |      |                   |     |
|   | Machine # | Command Code | Data Address    |                  | Data Information     |                      | CRC-16 Checking Code |                    |      |                    |      |                   |     |
|   | 64 H      | 06 H         | 00 H            | 01 H             | 00 H                 | 64 H                 | CRC                  | CRC                |      |                    |      |                   |     |
| Command Code (10H) Write In Multiple Records/Parameters of Controller     |           |              |                 |                  |                      |                      |                      |                    |      |                    |      |                   |     |
| Write In  | 0         | 1            | 2               | 3                | 4                    | 5                    | 6                    | 7                  | 8    | 9                  | 10   | 11                | 12  |
|   | Machine # | Command Code | Data Address    |                  | Data Record Quantity |                      | Data Bit Count       | Data 1 Information |      | Data 2 Information |      | CRC-16 Check Code |     |
|   | 64 H      | 10 H         | 00 H            | 01 H             | 00 H                 | 02 H                 | 04 H                 | 00 H               | 01 H | 00 H               | 01 H | CRC               | CRC |
| Feedback  | 0         | 1            | 2               | 3                | 4                    | 5                    | 6                    | 7                  |      |                    |      |                   |     |
|   | Machine # | Command Code | Data Address    |                  | Data Information     |                      | CRC-16 Checking Code |                    |      |                    |      |                   |     |
|   | 64 H      | 10 H         | 00 H            | 01 H             | 00 H                 | 02 H                 | CRC                  | CRC                |      |                    |      |                   |     |

**Contact the professionals at Fiber Optic Center for a quote or to get more details.**

[focenter.com](http://focenter.com) • 508-992-6464 | (800) 473-4237 • [sales@focenter.com](mailto:sales@focenter.com)

23 Centre Street • New Bedford, MA 02740 USA

*Product data subject to change without notice.*

**DC100 MAX Digital Dispenser Operating Manual**



| Command Read (R) / Write (W)   | Parameter                                  | Address Value      | Data Value        |
|--|--|--------------------|-------------------|
| R / W  | Dispensing                                 | 0x0001             | 0 – 1 (Hex)       |
| R / W  | Program Number                             | 0x0002             | 1 – 16 (Hex)      |
| R / W  | Mode                                       | 0x0003             | 1 – 5 (Hex)       |
| R / W  | Time P1 – P16                              | 0x0100 ... 0x010F: | 0000 – 9999 (Hex) |
| R / W  | Time Decimal Place Position P1 – P16       | 0x0110 ... 0x011F: | 1-3 (Hex)         |
| R / W  | Delay Time P1 – P16                        | 0x0120 ... 0x012F: | 0000 – 9999 (Hex) |
| R / W  | Delay Time Decimal Place Position P1 – P16 | 0x0130 ... 0x013F: | 1-3 (Hex)         |
| R / W  | Mode P1 – P16                              | 0x0140 ... 0x014F: | 1-5 (Hex)         |
| R  | Pressure kPa                               | 0x8001             | Integer Number    |
| R  | Pressure inHg                              | 0x8002             | Integer Number    |
| R  | Pressure kPa                               | 0x8003             | Integer Number    |
| R  | Vacuum kPa                                 | 0x8004             | 1 Decimal Place   |
| R  | Vacuum inHg                                | 0x8005             | 2 Decimal Place   |
| R  | Vacuum kPa                                 | 0x8006             | Intger Number     |
| Alarm Status 0x8007 (convert returned Hex value to Binary Value)         |  |                    |                   |
| R  | Dispense Limit Alarm                       |                    | Bit 0             |
| R  | Glue Alarm                                 |                    | Bit 1             |
| R  | Pressure Alarm                             |                    | Bit 2             |
| R  | Vacuum Alarm                               |                    | Bit 3             |
| R  | Input Alarm                                |                    | Bit 4             |
| Machine Input Status 0x8008 (convert returned Hex value to Binary Value) |  |                    |                   |
| R  | CC Stat Initialise                         |                    | Bit 0             |
| R  | Input Alarm                                |                    | Bit 1             |
| R  | 24V Start Initialise                       |                    | Bit 2             |
| R  | Clear / Reset                              |                    | Bit 3             |
| R  | Bit 0 Signal                               |                    | Bit 4             |
| R  | Bit 1 Signal                               |                    | Bit 5             |
| R  | Bit 2 Signal                               |                    | Bit 6             |
| R  | Bit 3 Signal                               |                    | Bit 7             |
| R  | Program Select                             |                    | Bit 8             |
| R  | Foot Switch                                |                    | Bit 9             |

**Contact the professionals at Fiber Optic Center for a quote or to get more details.**

[focenter.com](http://focenter.com) • 508-992-6464 | (800) 473-4237 • [sales@focenter.com](mailto:sales@focenter.com)

23 Centre Street • New Bedford, MA 02740 USA

*Product data subject to change without notice.*



| Command Read (R) / Write (W)  | Parameter                            | Hex Value          | Input Value (x) |
|---|--------------------------------------|--------------------|-----------------|
| Machine Output Status 0x8009 (convert returned Hex value to Binary Value) |                                      |                    |                 |
| R   | Alarm                                |                    | Bit 0           |
| R   | Busy                                 |                    | Bit 1           |
| R   | End of Cycle                         |                    | Bit 2           |
| R   | Ready                                |                    | Bit 3           |
| R   | Dispense Count P1-P16                | 0x8010 ... 0x801F  | 0 – 9999        |
| R   | Total Cycles                         | 0x8020 ... 0x8021: | 0 – 2147483647  |
| R   | Used Time (hours)                    | 0x8022 ... 0x8023  | 0 – 999999999   |
| R   | Used Time (minutes)                  | 0x8024             | 0 – 59          |
| R   | Used Time (seconds)                  | 0x8025             | 0 – 59          |
| R   | Software Version                     | 0x8026             | V1.0            |
| R / W   | Clear                                | 0xAAAA             | 0 – 3           |
| R / W   | Save                                 | 0xABCD             | 0 – 1           |
| Command Code Error + 0x80   |                                      |                    |                 |
| Error   | Command Code Incorrect               | 0x01               |                 |
| Error   | Data Address Incorrect               | 0x02               |                 |
| Error   | Data Incorrect or Value out of range | 0x03               |                 |

**Contact the professionals at Fiber Optic Center for a quote or to get more details.**

[focenter.com](http://focenter.com) • 508-992-6464 | (800) 473-4237 • [sales@focenter.com](mailto:sales@focenter.com)

23 Centre Street • New Bedford, MA 02740 USA

*Product data subject to change without notice.*