



**Manufacturer:**  
Micro Electronics Inc.

**Product Name:**  
Micro-Strip Stripper, .0055 (140um) Blade, .0180 (457um) Guide

**Manufacturer Part Number:**  
MS1-05S-18-FS

▶ Click here for more details on the Micro-Strip Stripper, .0055 (140um) Blade, .0180 (457um) Guide

Micro-Strip stripping tools from Micro-Electronics strip buffered fiber up to 2360um, and jacketed fiber up to 3.5mm quickly and easily.

You can use two standard handles with interchangeable cutter blade sets, fiber guides and fiber guide locks to strip all sizes. Simply select and install the proper cutter blade sets, tube guides, and tube guide locks.

Or if you prefer, purchase Micro-Strip tools individually fitted for the fiber or jacket diameter you specify with cutter blade sets and fiber guides already installed.

### Micro-Strip® Tool Breakdown

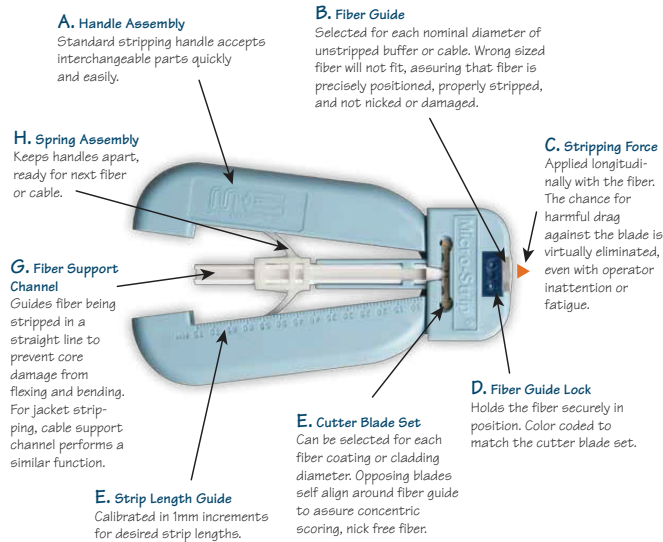

### Ultra-Precise Non-Thermal Stripping System

#### SNAP-APART PRECISION-MACHINED BLADE HALVES MOLDED INTO THERMOPLASTIC BODIES

Patented, self-centering stripping system assures precise, concentric scoring with no cladding or core damage.

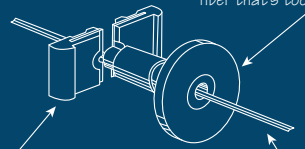

**B.** As gripping handles close, each blade half moves in a straight line to self-align around the fiber guide. This places the blades in perfect concentric relationship.

**A.** Fiber enters guide through opening dimensioned for a particular diameter range. Fiber that is too large won't enter the guide; fiber that's too small won't be stripped.

**C.** Fiber is withdrawn, assuring a perfect strip every time. Only the coating or buffer is scored. Fiber is never nicked or damaged.

#### PRECISION MACHINED FIBER GUIDE

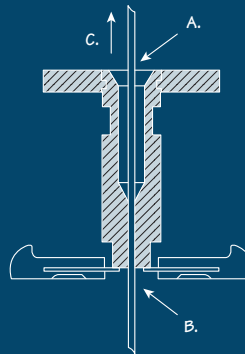

End of fiber guide supports blades during stripping to prevent blade flexing and fatigue.

Contact the professionals at Fiber Optic Center for a quote or to get more details.

[focenter.com](http://focenter.com) • 508-992-6464 | (800) 473-4237 • [sales@focenter.com](mailto:sales@focenter.com)

23 Centre Street • New Bedford, MA 02740 USA



**Manufacturer:**  
Micro Electronics Inc.

**Product Name:**  
Micro-Strip Stripper, .0055 (140um) Blade, .0180 (457um) Guide

**Manufacturer Part Number:**  
MS1-05S-18-FS

▶ Click here for more details on the Micro-Strip Stripper, .0055 (140um) Blade, .0180 (457um) Guide

## Non-Thermal Stripping Procedure

### PROPER TOOL SELECTION

Select the proper tool and components for either fiber stripping or jacket stripping by referring to the tables enclosed. If necessary, install proper fiber guide, fiber guide lock and cutter blade set.

### STRIPPING PROCEDURE (BUFFERED OPTICAL FIBER USING MS-1-FS TOOL)

1. Hold tool in one hand, fiber in the other. Keep handles in fully expanded position. Insert fiber through fiber guide until end lines up with markings to match desired strip length.

2. Squeeze handles closed. Cutter blades are now scoring the buffer or coating.

3. While maintaining a slight pressure to keep the stripper blades closed, withdraw fiber from tool, completing the stripping process.

### STRIPPING PROCEDURE (BUFFERED OPTICAL FIBER USING MS-2-L TOOL WITH LATCH BAR)

1. Insert cable through fiber guide. Align end of cable with rule marking at desired strip length.

2. Close handles together while blades cut into jacket while holding handles closed, flip latch bar down around pin. Release handles to latched, semi-open position. Do not reclose handles. Move hand up to grasp head of tool. While other hand is holding cable firmly, pull with a quick smooth motion. Flip latch off pin. Stripped jacket will fall out through rear of channel when handles are fully open.

**Note:** Never leave tool with latch in locked position. This can cause Delrin spring to take set, preventing handles from opening fully. When stripping hard, tough or thick jackets, it is NOT necessary to use latch bar. Lock bar out of the way by tightening the screw.

1. Insert correct fiber/wire through guide and into support channel to desired strip length.

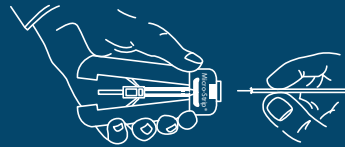

2. Close handles. Blade sets cut almost through the insulation without ever touching the fiber/wire.

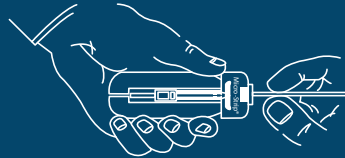

3. With handles closed, pull fiber/wire or cable from tool. Always a precision strip length. Fiber/wire is never nicked or damaged.

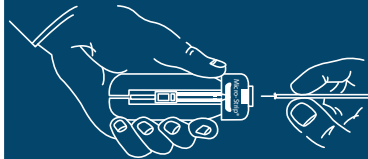

## Ultra-Versatile

## Coating / Buffer Stripping

## Jacket Stripping

Use these two standard handles to strip buffered fiber up to 900µm, or jacketed fiber up to 3.5mm quickly and easily. Simply select and install the proper cutter blade sets, fiber guides and fiber guide locks. Or, if you prefer, purchase Micro-Strip® tools individually fitted for the fiber of jacket diameter you specify. Cutter blade sets and fiber guides come pre-installed.

MS-1-FS tool with interchangeable cutter blades and fiber guides can mechanically strip buffered fiber up to 2300µm.

**Cutter Blade Sets:** 18 sizes for 80um to 1350µm fiber.

**Fiber Guides:** 20 sizes, for 180um to 2360µm coatings.

**Fiber Guide Locks:** Provided with cutter blade sets.



MS-2-L tool with interchangeable cutter blades and fiber guides can mechanically strip jackets for 2.5mm, 3.0mm, and 3.5mm cable.

**Cutter Blade Sets:** One standard size 0.054' dia.

**Fiber Guides:** 3 sizes for 2.5mm, 3.0mm, and 3.5mm jackets.

**Fiber Guide Locks:** Provided with cutter blade sets.

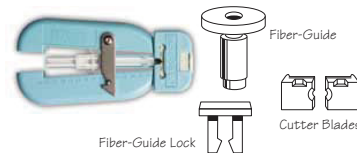

Contact the professionals at Fiber Optic Center for a quote or to get more details.

[focenter.com](http://focenter.com) • 508-992-6464 | (800) 473-4237 • [sales@focenter.com](mailto:sales@focenter.com)

23 Centre Street • New Bedford, MA 02740 USA



**Manufacturer:**  
Micro Electronics Inc.

**Product Name:**  
Micro-Strip Stripper, .0055 (140um) Blade, .0180 (457um) Guide

**Manufacturer Part Number:**  
MS1-05S-18-FS

▶ Click here for more details on the Micro-Strip Stripper, .0055 (140um) Blade, .0180 (457um) Guide

## Micro-Strip® Ordering Information

1. From table, identify coating or cladding diameter you wish to strip down to. Read across to Complete Tool Cat. No.

2. From Fiber Guide Selection table, identify desired coating or buffer diameter to learn Fiber Guide Cat. No. Put 2-digit code in Complete Tool Cat. No. space to complete it.

3. Order complete tool. Proper cutter blade set and fiber guide will be provided.

4. Order replacement cutter blade sets and fiber guides as needed.

1. From table, identify jacket diameter you wish to strip. Read across to Complete Tool Cat. No.

2. Order complete tool. Proper cutter blade set and jacket guide will be provided.

3. Order replacement cutter blade sets and jacket guides as needed.

COMPLETE TOOLS AND REPLACEMENT BLADE SETS FOR OPTICAL FIBER					
Fiber Cladding Diameter to Expose (µm)	Proper Blade Dia. (in.)	Complete Tool Cat. No. †	Replacement Cutter Blade Set Cat. No.*	Blade Color Code	
up to 80	up to .0031	.0045	MS1-04S--FS	MS1-RB-04S	CLEAR
85-120	.0033-.0047	.0055	MS1-05S--FS	MS1-RB-05S	LAVENDER
125-135	.0049-.0053	.0063	MS1-06S--FS	MS1-RB-06S	PURPLE
125-175	.0049-.0068	.008	MS1-08S--FS	MS1-RB-08S	RED
180-230	.0070-.0090	.010	MS1-10S--FS	MS1-RB-10S	LIGHT BLUE
235-280	.0092-.0110	.012	MS1-12S--FS	MS1-RB-12S	WHITE
285-330	.0112-.0129	.014	MS1-14S--FS	MS1-RB-14S	DARK GREEN
335-380	.0131-.0149	.016	MS1-16S--FS	MS1-RB-16S	ORANGE
385-430	.0151-.0169	.018	MS1-18S--FS	MS1-RB-18S	YELLOW
435-500	.0171-.0196	.021#	MS1-21S--FS	MS1-RB-21S	ROYAL BLUE
505-550	.0198-.0216	.023	MS1-23S--FS	MS1-RB-23S	MAROON
555-600	.0218-.0236	.025	MS1-25S--FS	MS1-RB-25S	LIGHT GREEN
605-680	.0238-.0267	.028##	MS1-28S--FS	MS1-RB-28S	BLACK
685-750	.0269-.0295	.031	MS1-31--	MS1-RB-31S	TAN
755-830	.0297-.0326	.034	MS1-34--	MS1-RB-34S	PINK
835-900	.0328-.0354	.037	MS1-37--	MS1-RB-37S	GRAY
905-1050	.0356-.0413	.044	MS1-44--	MS1-RB-44S	DARK BROWN
1055-1350	.0415-.0531	.054	MS1-54--	MS1-RB-54S	NATURAL

For best results use .0063 inch blade when removing 250µm coating.  
 For best results use .0080 inch blade when removing 900µm buffer.  
 # For best results when stripping secondary buffer down to primary 250µm coating use blade size .021.  
 ## For best results when stripping secondary buffer down to primary 500µm coating use blade size .028.  
 † Includes tool individually boxed with cleaning tool, push tool and instructions.  
 \* Catalog numbers are for two cutter blade sets packaged together with a matching fiber guide lock. Each blade set consists of a pair of joined, matched blades which must be snapped apart prior to use. Matched cutter blade sets are NOT interchangeable, and must only be used with their matching half.

FIBER GUIDE SELECTION	
Fiber Coating or Buffer Dia. (µm)to Strip	Replacement Fiber Guide Cat. No.▲
up to 180	MS1-RT-07
180-250	MS1-RT-10
250-343	MS1-RT-13
343-407	MS1-RT-16
407-457	MS1-RT-18
457-533	MS1-RT-21
533-635	MS1-RT-25
635-787	MS1-RT-31
787-889	MS1-RT-35
889-1016	MS1-RT-40
1016-1168	MS1-RT-46
1168-1321	MS1-RT-52
1321-1397	MS1-RT-55
1397-1600	MS1-RT-63
1600-1702	MS1-RT-67
1702-1778	MS1-RT-70
1778-1930	MS1-RT-76
1930-2057	MS1-RT-81
2057-2184	MS1-RT-86
2184-2362	MS1-RT-93

▲ Catalog numbers are for a single, individually packaged fiber guide with integral size indicator disk.

COMPLETE TOOLS AND REPLACEMENT BLADE SETS FOR JACKET STRIPPING					
Jacket Diameter (µm)	Blade dia. (in.)	Complete Tool Cat. No. ††	Replacement Cutter Blade Set Cat. No.*	Blade Color Code	
2.5	.098	.054	MS2-54S-D1	MS2-RB-54S	NATURAL
3.0	.118	.054	MS2-54S-D2	MS2-RB-54S	NATURAL
3.5	.137	.054	MS2-54S-D3	MS2-RB-54S	NATURAL

MS-1 and MS-2 components are not interchangeable.  
 \* Catalog are for two cutter blade sets packaged together with a matching fiber guide lock. Each blade set consists of a pair of joined, matched blades which must be snapped apart prior to use. Matched cutter blade sets are NOT interchangeable, and must only be used with their matching half.

REPLACEMENT HANDLE ASSEMBLY	
Handle Assembly*	Application
MS-1-FS	Fiber coating/buffer stripping up to 2360µm
MS-2-L	Jacket stripping up to 3.5mm

† Includes tool individually boxed with cleaning brush, push tool and instructions.  
 †† Catalog numbers are for single individually packaged Jacket Guide (with integral size indicator disk).  
 \* Includes handle individually boxed with cleaning brush, push tool and instructions. Cutter blade set and fiber guide are NOT included.

### OPTICAL FIBER TERMINOLOGY

Optical Fiber, made of glass, fused silica, or plastic transmits light much as metallic wire carries electricity. Optical fibers are encased in various ways to meet application requirements. Shown here are the typical components of optical fiber:

- BUFFER** - Material that protects an optical fiber from physical damage.
- COATING** - Material in intimate contact with the cladding surface, applied to preserve its integrity.
- CLADDING** - The dielectric material surrounding an optical fiber's core.
- CORE** - The central region of an optical fiber through which light is transmitted.
- MULTIPLE-FIBER RIBBON** - A formed, flat carrier of several optical fibers.
- OPTICAL CABLE** - A fiber, multiple fibers, or fiber bundle in a structure fabricated to meet optical, mechanical, and environmental specifications.

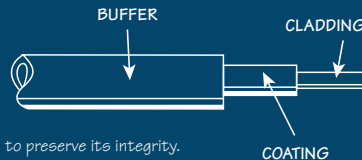

Contact the professionals at Fiber Optic Center for a quote or to get more details.

[focenter.com](http://focenter.com) • 508-992-6464 | (800) 473-4237 • [sales@focenter.com](mailto:sales@focenter.com)

23 Centre Street • New Bedford, MA 02740 USA



**Manufacturer:**  
Micro Electronics Inc.

**Product Name:**  
Micro-Strip Stripper, .0055 (140um) Blade, .0180 (457um) Guide

**Manufacturer Part Number:**  
MS1-05S-18-FS

▶ Click here for more details on the Micro-Strip Stripper, .0055 (140um) Blade, .0180 (457um) Guide

Soft-Strip® stripping tools from Mico Electronics have integral heating elements which enable them to soften and strip such coatings and insulations as Mylene, KAPTON, TEFLON, PVC, and HYTREL.

The Soft-Strip® system permits precise stripping of these tough coatings with less than three pounds of peak pulling force for multi-fiber ribbon, and less than one pound for single fiber.

The result is no fiber damage and higher quality splices and connections. Units are available for optical fiber (180-1000µm) and all standard multi-fiber ribbons (encapsulated, bonded, and ribbonized types). Custom tools are also available.

### Soft-Strip® Tool Breakdown

**A. Handle Assembly**

Battery or AC adapter operated. 4 ft. wire leads are connected to either a 6V battery or AC adapter.

**B. Cutter Blade Set**

Selected for each ribbon or fiber size. Opposing blades self align around fiber guide to assure concentric scoring and precision-stripped, nick free fiber. Blades travel in a straight line to assure proper alignment. Color coded to match fiber guide lock.

**H. Spring Assembly**

Keeps handles apart. In later models, also ejects scrap from heater oven.

**C. Fiber Guide Lock**

Holds the fiber securely in position. Color coded to match the cutter blade set.

**G. Heater Oven**

Heats and softens material to be stripped. Activated when handles are closed. Accommodates up to 2" maximum strip length.

**D. Stripping Force**

Applied longitudinally with the fiber. The chance for harmful drag against the blade is virtually eliminated, even with operator inattention or fatigue.

**E. Fiber Guide**

Selected for each nominal diameter of unstripped fiber, wire, or ribbon. Wrong size will not fit, assuring that the fiber is properly stripped, and not nicked or damaged.

**F. Strip Length Guide**

Calibrated in 1mm increments for desired strip lengths.

### Self-Contained AA Battery-Powered Thermal Stripping System

IDEAL FOR FIELD WORK. USE EITHER ALKALINE OR NICKEL METAL HYDRIDE BATTERIES UP TO 50 STRIPPING OPERATIONS PER CHARGE. 1" MAXIMUM STRIP LENGTH



The AA Battery-powered unit has all the same heating, blade and stripping features found on the standard Soft-Strip® tool.

The self contained, wire-free, power source allows for exceptional freedom of movement and portability.

Uses 2 AA batteries, either traditional alkaline, or rechargeable Nickel Metal Hydride. (See accessories page for more information).

#### GETTING CHARGED ...

All AC/6V Thermal Stripping units can be powered by either a 6V battery pack (shown here with case) or by a 100-240V AC adapter (European adapters available). See the accessories page for details.



Contact the professionals at Fiber Optic Center for a quote or to get more details.

[focenter.com](http://focenter.com) • 508-992-6464 | (800) 473-4237 • [sales@focenter.com](mailto:sales@focenter.com)

23 Centre Street • New Bedford, MA 02740 USA



**Manufacturer:**  
Micro Electronics Inc.

**Product Name:**  
Micro-Strip Stripper, .0055 (140um) Blade, .0180 (457um) Guide

**Manufacturer Part Number:**  
MS1-05S-18-FS

▶ [Click here for more details on the Micro-Strip Stripper, .0055 \(140um\) Blade, .0180 \(457um\) Guide](#)

## Thermal Stripping Procedure

Strip outer jacket (if any) using the Soft Strip® non-thermal tool. Install and connect battery(s), or install and connect AC adapter. Install proper cutter blade set, fiber guide and fiber guide lock.

### HEATER OVEN

Unit is activated when handles are closed. Close handles only when stripping. Check heater operation by closing handles firmly for no longer than ten seconds. Nose end of heater should be warm to the touch.

After stripping operation, remove heater oven from tool and clean with brush provided (spring assembly in later models include automatic scrap ejector). Reinsert, making sure that the heater oven is pushed completely forward toward the blade area and snaps into place. The 2" heater oven area should be visible at front of tool so operator can monitor positioning and preheating of coating.

### STRIPPING PROCEDURE

1. Insert fiber through fiber guide and into heater oven to desired length. Be sure buffered fiber is flat in the oven channel. Otherwise, heater oven movement will cause fiber to buckle up and out of the heating zone.

2. Close handles completely. Blades are precisely aligned for concentric scoring without cladding, core, or conductor damage. Heater oven is automatically activated to start softening process.

3. Keep handles closed (AA 10-20 seconds, 6V or AC adapter 4-8 seconds) for optimum softening. Then, begin to pull the fiber, slowly increasing pull force until coating releases from the fiber. Remove the fiber from the tool with a smooth, even motion.

**Note:** Heater unit heats continuously when handles are closed. Do not hold handles closed for longer than 20 seconds for AA battery units. 10 seconds for 6V battery/AC adapter units, or overheating can damage the tool. Do not touch heater oven while in operation. Allow to cool before removal and cleaning.

1. Insert correct fiber/wire through guide and into heater cartridge slot to desired strip length.

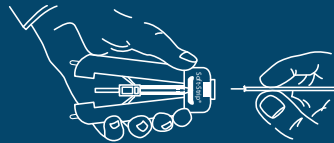

2. Close handles. Blade sets cut almost through the insulation, heater oven is also activated.

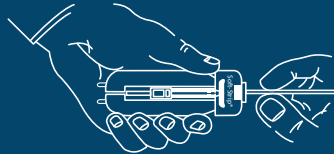

3. With handles closed for 5-10 seconds, pull fiber/wire from tool. Always a precision strip length. Fiber/wire is never nicked or damaged.

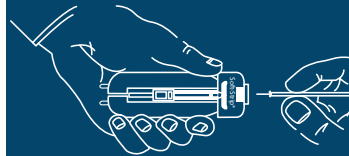

## UltraVersatile

Use these two standard handles to strip buffered fiber up to 900µm, or 2 to 12 fiber ribbon quickly and easily. Simply select and install the proper cutter blade sets, fiber guides and fiber guide locks.

Or, if you prefer, purchase Soft-Strip® tools individually fitted for the multi-fiber ribbon you specify. Cutter blade sets, fiber guides and fiber guide locks come already installed.

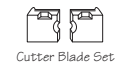

Contact the professionals at Fiber Optic Center for a quote or to get more details.

[focenter.com](http://focenter.com) • 508-992-6464 | (800) 473-4237 • [sales@focenter.com](mailto:sales@focenter.com)

23 Centre Street • New Bedford, MA 02740 USA

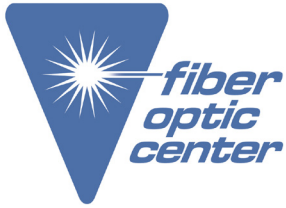

**Manufacturer:**  
Micro Electronics Inc.

**Product Name:**  
Micro-Strip Stripper, .0055 (140um) Blade, .0180 (457um) Guide

**Manufacturer Part Number:**  
MS1-05S-18-FS

▶ Click here for more details on the Micro-Strip Stripper, .0055 (140um) Blade, .0180 (457um) Guide

## Soft-Strip® Ordering Information

### Complete Ribbon Stripping Tools and Replacements

- From table, identify ribbon type you wish to strip. Read across to Complete Tool Cat. No.
- Select desired power supply from Table A and insert identifying letter (B or T) in empty space.
- Order complete tool. Proper cutter blade set and ribbon guide will be provided. **Order T type power supplies separately from table A below.**
- Order replacement cutter blade sets and ribbon guides as needed.

COMPLETE RIBBON STRIPPING TOOLS AND REPLACEMENT COMPONENTS				
Ribbon Type	Complete Tool Cat. No. †	Replacement Cutter Blade Set Cat. No.*	Replacement Ribbon Guide Cat. No.▲	
AT & T ASR	MS-3 -06-G1	MS3-RB-06	MS-3-RT-G1	
12-FIBER 'B' 'R'	MS-3 -06-G2	MS3-RB-06	MS-3-RT-G2	
4-FIBER 'E'	MS-3 -06-G3	MS3-RB-06	MS-3-RT-G3	
8-FIBER 'E'	MS-3 -06-G4	MS3-RB-06	MS-3-RT-G4	
4-FIBER 'B'	MS-3 -06-G5	MS3-RB-06	MS-3-RT-G5	
8-FIBER 'B'	MS-3 -06-G6	MS3-RB-06	MS-3-RT-G6	
10-FIBER 'E'	MS-3 -06-G7	MS3-RB-06	MS-3-RT-G7	
10-FIBER 'B'	MS-3 -06-G8	MS3-RB-06	MS-3-RT-G8	
6-FIBER 'B'	MS-3 -06-G10	MS3-RB-06	MS-3-RT-G10	
12-FIBER 'E'	MS-3 -06-G15	MS3-RB-06	MS-3-RT-G15	

MS-SK-1 Thermal Stripping Kit Includes necessary components for stripping all ribbon except 18-fiber ribbon.

\* Catalog numbers are for two cutter blade sets packaged together with a matching color-coded fiber lock. Each cutter blade set consists of a pair of joined, matched blades which must be snapped apart prior to use. Matched cutter blade sets are NOT interchangeable, and must only be used with their matching half.

▲ Catalog numbers are for a single, individually packaged ribbon guide with integral size indicator disk.

'E'- Encapsulated 'B'- Bonded 'R'- Ribbonized  
† Includes tool individually boxed with cleaning tool, push tool and instructions.

### Complete Fiber Stripping Tools and Replacements

- From table, identify fiber coating or cladding diameter you wish to strip down to. Read across to Complete Tool Cat. No.
- Select desired power supply from Table A below and insert identifying letter (B or T) in first space.
- From Fiber selection Guide table, identify desired coating or buffer diameter, and insert 2 digit code at end of Complete Tool Cat. No. to complete it.
- Order complete tool. Proper cutter blade set and fiber guide will be provided. **Order T type power supplies separately from table A below.**
- Order replacement cutter blade sets and fiber guides as needed.

COMPLETE TOOLS AND REPLACEMENT BLADE SETS FOR OPTICAL FIBER				
Fiber Cladding Diameter to Expose (µm)	Proper Blade Dia. (in.)	Complete Tool Cat. No. †	Replacement Cutter Blade Set Cat. No.*	Blade Color Code
up to 80	up to .0031	.0045 MS-4 04S-	MS1-RB-04S	CLEAR
85-120	.0033-.0047	.0055 MS-4 05S-	MS1-RB-05S	LAVENDER
125-135	.0049-.0053	.0063 MS-4 06S-	MS1-RB-06S	PURPLE
125-175	.0049-.0068	.008 MS-4 08S-	MS1-RB-08S	RED
180-230	.0070-.0090	.010 MS-4 10S-	MS1-RB-10S	LIGHT BLUE
235-280	.0092-.0110	.012 MS-4 12S-	MS1-RB-12S	WHITE
285-330	.0112-.0129	.014 MS-4 14S-	MS1-RB-14S	DARK GREEN
335-380	.0131-.0149	.016 MS-4 16S-	MS1-RB-16S	ORANGE
385-430	.0151-.0169	.018 MS-4 18S-	MS1-RB-18S	YELLOW
435-500	.0171-.0196	.021# MS-4 21S-	MS1-RB-21S	ROYAL BLUE
505-550	.0198-.0216	.023 MS-4 23S-	MS1-RB-23S	MAROON
555-600	.0218-.0236	.025 MS-4 25S-	MS1-RB-25S	LIGHT GREEN
605-680	.0238-.0267	.028## MS-4 28S-	MS1-RB-28S	BLACK

FIBER GUIDE SELECTION FOR SINGLE OPTICAL FIBERS	
Fiber Coating or Buffer Dia. (µm) to Strip	Replacement Fiber Guide Cat. No.▲
up to 180	MS1-RT-07
180-250	MS1-RT-10
250-343	MS1-RT-13
343-407	MS1-RT-16
407-457	MS1-RT-18
457-533	MS1-RT-21
533-635	MS1-RT-25
635-787	MS1-RT-31
787-889	MS1-RT-35
889-1016	MS1-RT-40

For best results use .0063 inch blade when removing 250µm coating.  
For best results use .0080 inch blade when removing 900µm buffer.  
# For best results when stripping secondary buffer down to primary 250µm coating use blade size .021.  
## For best results when stripping secondary buffer down to primary 500µm coating use blade size .028.  
† Includes tool individually boxed with cleaning tool, push tool and instructions.  
\* Catalog numbers are for two cutter blade sets packaged together with a matching fiber guide lock. Each blade set consists of a pair of joined, matched blades which must be snapped apart prior to use. Matched cutter blade sets are NOT interchangeable, and must only be used with their matching half.

▲ Catalog numbers are for a single, individually packaged fiber guide with integral size indicator disk.

### Soft-Strip® Accessories / Replacement Parts

TABLE A: POWER SUPPLIES

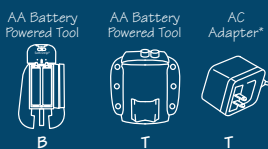

REPLACEMENT HANDLE ASSEMBLIES		
Handle Assembly	Capacity	Max. Strip Length
MS-3B-E	2-12 fibers	1"
MS-3T-E	2-12 fibers	2-3"
MS-4B-E	single fiber	1"
MS-4T-E	single fiber	2-3"

REPLACEMENT HEATER OVENS	
Catalog No.	
MS-RHM-1	
MS-RHM-2	
MS-RHM-1	
MS-RHM-2	

\* Order separately. NOTE: Batteries not included.

Contact the professionals at Fiber Optic Center for a quote or to get more details.

[focenter.com](http://focenter.com) • 508-992-6464 | (800) 473-4237 • [sales@focenter.com](mailto:sales@focenter.com)

23 Centre Street • New Bedford, MA 02740 USA



**Manufacturer:**  
Micro Electronics Inc.

**Product Name:**  
Micro-Strip Stripper, .0055 (140um) Blade, .0180 (457um) Guide

**Manufacturer Part Number:**  
MS1-05S-18-FS

▶ Click here for more details on the Micro-Strip Stripper, .0055 (140um) Blade, .0180 (457um) Guide

## Micro-Strip® /Soft-Strip® Cutter Blade Replacement

### TO REMOVE INSTALLED BLADES:

1. Using flat end of push tool, remove fiber guide lock by pushing out from the back side of tool head.
2. Remove Fiber guide from tool.
3. Using prong end of push tool in small holes on back side of tool head, eject blade set.

### IMPORTANT!

*Do not remove cutter blades while fiber guide is still in tool.*

### TO INSTALL NEW BLADES:

(Furnished in a matched set for blade precision. Snap apart before installation.)

1. Install with "ears" pointing toward top of tool and recess marks visible. Push firmly with flat end of push tool until both blades are seated.
2. Insert fiber guide through hole in top of tool until it stops.
3. Insert fiber guide lock through slot in front of tool head.

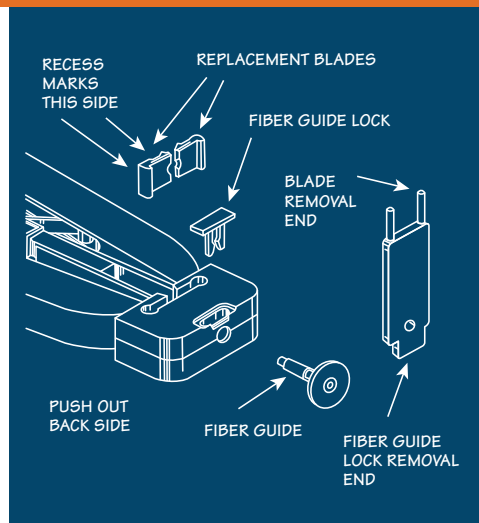

**Note:** Blades are color coded and matched to diameter and color of fiber guide lock. Replace or install fiber guide and fiber guide lock as needed. Always test strip fiber after installing new blade set. Remove blades periodically and clean with brush provided and alcohol.

## The Best Non-Thermal / Thermal Stripping Tools

### Accuracy

Every stripping component of the Micro-Strip® system is manufactured to tolerances tighter than 0.0005".

### Error Proof

Because Micro-Strip®'s components are color coded, there's no chance for error, and virtually no chance of fiber damage. Every detail of Micro-Strip®'s design has been tested, retested, and proven in the field since 1973.

### The Right Tool

You can order a variety of standard Micro-Strip® tools already fitted with your desired fiber guide and cutter blade set. You can also order replacement blade sets and guides so the same handle can be used to strip many sizes of fiber or cable.



### Tool Kits

Convenient Micro-Strip® and Soft-Strip® kits include the most used components for fiber optic stripping, along with complete instructions, cleaning brush and component tool.

### Versatility

There's no need to purchase separate tools for each fiber size. Micro-Strip®'s modular blade sets are quickly interchangeable and replaceable for coated optical fibers up to 2300µm, or jacketed fibers up to 3.5mm.

### Low Stripping Force

Lower stripping force means less stress on the fiber and higher quality splices.

Micro-Strip® requires less than a pound of peak force for stripping coated fiber.

Contact the professionals at Fiber Optic Center for a quote or to get more details.

[focenter.com](http://focenter.com) • 508-992-6464 | (800) 473-4237 • [sales@focenter.com](mailto:sales@focenter.com)

23 Centre Street • New Bedford, MA 02740 USA



**Manufacturer:**  
Micro Electronics Inc.

**Product Name:**  
Micro-Strip Stripper, .0055 (140um) Blade, .0180 (457um) Guide

**Manufacturer Part Number:**  
MS1-05S-18-FS

▶ [Click here for more details on the Micro-Strip Stripper, .0055 \(140um\) Blade, .0180 \(457um\) Guide](#)

## Micro-Strip® Kit Information

### Fiber Optic and A.W.G. Wire Stripping Starter Kits



#### Fiber Optic Stripping Kit

This fiber optic stripping kit, **MS-FOK-1**, contains stripping tool, blade and fiber guide components for both outer jacket stripping (up to 3.5mm) and coating/buffer stripping (up to 900µm). It comes packaged in an attractive metal case.



#### Fiber Optic Stripping Kit

This convenient three-step fiber optic stripping kit, **MS-FOK-2**, contains Kevlar scissors and prefitted strippers for outer jackets (up to 3.5mm), 900µm buffers and 250µm coatings.



#### A.W.G. Wire Stripping Kit

This A.W.G. wire stripping kit, **MS-TK-1**, is used for precision stripping of 18-32 gage fine wire. It contains a standard stripping handle with a variety of blade and guide components for stripping a wide range of solid or stranded wire.

## Soft-Strip® Kit Information

### Thermal Stripping Starter Kits



#### Multi-Fiber Thermal Stripping Kit

The **MS-SK-1** kit contains the patented Soft-Strip® thermal stripper and components necessary for stripping the most popular ribbon types including 2-12 fiber encapsulated, bonded or ribbonized constructions. It is powered by an AC wall outlet adapter (order separately).



#### Single-Fiber Thermal Stripping Kit

The **MS-SK-2** kit includes patented Soft-Strip® thermal stripper and components necessary for stripping discrete fibers with Cladding diameter up to 140µm and Coating/Buffer diameter up to 900µm. It is powered by an AC wall outlet adapter (order separately).

**Contact the professionals at Fiber Optic Center for a quote or to get more details.**





**Manufacturer:**  
Micro Electronics Inc.

**Product Name:**  
Micro-Strip Stripper, .0055 (140um) Blade, .0180 (457um) Guide

**Manufacturer Part Number:**  
MS1-05S-18-FS

▶ Click here for more details on the Micro-Strip Stripper, .0055 (140um) Blade, .0180 (457um) Guide

## Additional Items, Accessories and Options



### MICRO-STRIP® SCISSORS

**MS-SZR-1** Reliable, multipurpose scissors for use in fiber optic and electrical service applications. Serrated models for non-slip Kevlar cutting and fiber or wire cutting. Stripping notches for 19 and 23 A.W.G. fine wire. File on back edge of blade to sharpen.

### BLADE CLEANING BRUSHES



**MS-CB-1** (single ended)  
**MS-CB-2** (double ended)  
Both of these useful brushes are for removing residue from blade area normal to the stripping operation.

### COMPONENT REMOVAL AND INSERTION TOOL



**MS-PT-1** Facilitates easy removal for replacing or interchanging a wide range of Micro-Strip® blade set and fiber guide packages.

### FIBER OPTIC SCRIBES



**MS-FO-90-DW** For a wide cutting surface, the deluxe 90° Wedge Diamond Scribe is housed in an attractive retractable type metal casing.



**MS-FO-60-SW** For an even wider cutting surface, this 60° Wedge Sapphire Scribe is housed in an attractive retractable type metal casing.



**MS-FO-60-DC** This economy Diamond Scribe has a 60° conical point housed in an attractive retractable type metal casing.



MS-FO-90-DW MS-FO-60-SW MS-FO-60-DC



### MICRO-STRIP® SCISSORS

**MS-SZR-2** Ergonomic handle, reliable, multipurpose scissors for use in fiber optic and electrical service applications. Serrated models for non-slip Kevlar cutting and fiber or wire cutting. Stripping notches for 19 and 23 A.W.G. fine wire. File on back edge of blade to sharpen.

### REPLACEMENT SOFT-STRIP® HEATER CARTRIDGES



**MS-RHM-1** (for models **MS-3B** and **MS-4B**) Used with AA battery powered thermal stripper only. 30mm maximum strip length.

**MS-RHM-2** (for models **MS-3T** and **MS-4T**) Used with AC adapter / 6V battery powered thermal strippers only. 60mm maximum strip length.

### SOFT-STRIP® ADAPTERS



**MS-T3** (North American / Japan Shown)



### 6 VOLT BATTERY CASE



**MS-BC-2** This convenient 6V battery case can be worn on your belt. It's ideal for field work when no electrical power is available.

It works with the same thermal stripper as the AC adapter. Leads are included.

Contact the professionals at Fiber Optic Center for a quote or to get more details.

[focenter.com](http://focenter.com) • 508-992-6464 | (800) 473-4237 • [sales@focenter.com](mailto:sales@focenter.com)

23 Centre Street • New Bedford, MA 02740 USA

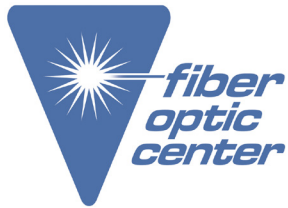

Manufacturer: Micro Electronics Inc.

Product Name: Micro-Strip Stripper, .0055 (140um) Blade, .0180 (457um) Guide

Manufacturer Part Number: MS1-05S-18-FS

Click here for more details on the Micro-Strip Stripper, .0055 (140um) Blade, .0180 (457um) Guide

Manufacturer Part Number:

Table listing various manufacturer part numbers in 7 columns, including models like MS-3T-06/2-G20, MS1-18S-25-FS, MS1-12S-46-FS, etc.

Contact the professionals at Fiber Optic Center for a quote or to get more details.

focenter.com • 508-992-6464 | (800) 473-4237 • sales@focenter.com

23 Centre Street • New Bedford, MA 02740 USA