



Manufacturer:
Micro Electronics

Product Name:
Micro-Strip Stripper, .0210 (533um) Blade, .0630 (1600um) Guide

Manufacturer Part Number:
MS1-21S-63-FS

▶ [Click here for more details on the Micro-Strip Stripper, .0210 \(533um\) Blade, .0630 \(1600um\) Guide](#)

Micro-Strip stripping tools from Micro-Electronics strip buffered fiber up to 2360µm, and jacketed fiber up to 3.5mm quickly and easily.

You can use two standard handles with interchangeable cutter blade sets, fiber guides and fiber guide locks to strip all sizes. Simply select and install the proper cutter blade sets, tube guides, and tube guide locks.

Or if you prefer, purchase Micro-Strip tools individually fitted for the fiber or jacket diameter you specify with cutter blade sets and fiber guides already installed.

Micro-Strip® Tool Breakdown

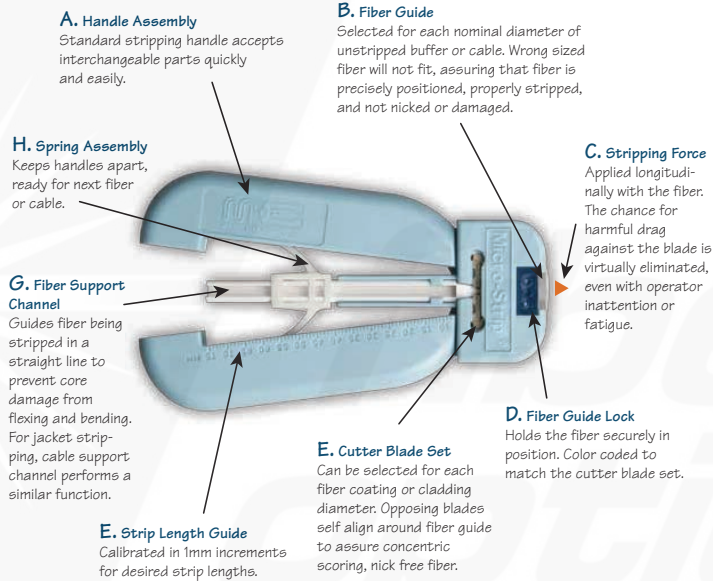

Ultra-Precise Non-Thermal Stripping System

SNAP-APART PRECISION-MACHINED BLADE HALVES MOLDED INTO THERMOPLASTIC BODIES

Patented, self-centering stripping system assures precise, concentric scoring with no cladding or core damage.

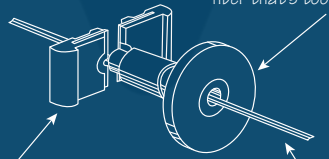

B. As gripping handles close, each blade half moves in a straight line to self-align around the fiber guide. This places the blades in perfect concentric relationship.

A. Fiber enters guide through opening dimensioned for a particular diameter range. Fiber that is too large won't enter the guide; fiber that's too small won't be stripped.

C. Fiber is withdrawn, assuring a perfect strip every time. Only the coating or buffer is scored. Fiber is never nicked or damaged.

PRECISION MACHINED FIBER GUIDE

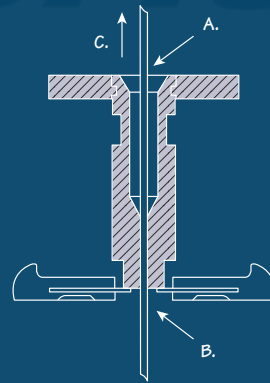

End of fiber guide supports blades during stripping to prevent blade flexing and fatigue.

Contact the professionals at Fiber Optic Center for a quote or to get more details.

focenter.com • 508-992-6464 | (800) 473-4237 • sales@focenter.com

23 Centre Street • New Bedford, MA 02740 USA

Product specifications and data are subject to change without notice. FOC last update 04/27/2026.



Manufacturer:
Micro Electronics

Product Name:
Micro-Strip Stripper, .0210 (533um) Blade, .0630 (1600um) Guide

Manufacturer Part Number:
MS1-215-63-FS

▶ [Click here for more details on the Micro-Strip Stripper, .0210 \(533um\) Blade, .0630 \(1600um\) Guide](#)

Micro-Strip® Ordering Information

1. From table, identify coating or cladding diameter you wish to strip down to. Read across to Complete Tool Cat. No.

2. From Fiber Guide Selection table, identify desired coating or buffer diameter to learn Fiber Guide Cat. No. Put 2-digit code in Complete Tool Cat. No. space to complete it.

3. Order complete tool. Proper cutter blade set and fiber guide will be provided.

4. Order replacement cutter blade sets and fiber guides as needed.

1. From table, identify jacket diameter you wish to strip. Read across to Complete Tool Cat. No.

2. Order complete tool. Proper cutter blade set and jacket guide will be provided.

3. Order replacement cutter blade sets and jacket guides as needed.

COMPLETE TOOLS AND REPLACEMENT BLADE SETS FOR OPTICAL FIBER					
Fiber Cladding Diameter to Expose (µm)	Proper Blade Dia. (in.)	Complete Tool Cat. No. †	Replacement Cutter Blade Set Cat. No.*	Blade Color Code	
up to 80	up to .0031	.0045	MS1-04S -FS	MS1-RB-04S	CLEAR
85-120	.0033-.0047	.0055	MS1-05S -FS	MS1-RB-05S	LAVENDER
125-135	.0049-.0053	.0063	MS1-06S -FS	MS1-RB-06S	PURPLE
125-175	.0049-.0068	.008	MS1-08S -FS	MS1-RB-08S	RED
180-230	.0070-.0090	.010	MS1-10S -FS	MS1-RB-10S	LIGHT BLUE
235-280	.0092-.0110	.012	MS1-12S -FS	MS1-RB-12S	WHITE
285-330	.0112-.0129	.014	MS1-14S -FS	MS1-RB-14S	DARK GREEN
335-380	.0131-.0149	.016	MS1-16S -FS	MS1-RB-16S	ORANGE
385-430	.0151-.0169	.018	MS1-18S -FS	MS1-RB-18S	YELLOW
435-500	.0171-.0196	.021#	MS1-21S -FS	MS1-RB-21S	ROYAL BLUE
505-550	.0198-.0216	.023	MS1-23S -FS	MS1-RB-23S	MAROON
555-600	.0218-.0236	.025	MS1-25S -FS	MS1-RB-25S	LIGHT GREEN
605-680	.0238-.0267	.028##	MS1-28S -FS	MS1-RB-28S	BLACK
685-750	.0269-.0295	.031	MS1-31S -FS	MS1-RB-31S	TAN
755-830	.0297-.0326	.034	MS1-34S -FS	MS1-RB-34S	PINK
835-900	.0328-.0354	.037	MS1-37S -FS	MS1-RB-37S	GRAY
905-1050	.0356-.0413	.044	MS1-44S -FS	MS1-RB-44S	DARK BROWN
1055-1350	.0415-.0531	.054	MS1-54S -FS	MS1-RB-54S	NATURAL

For best results use .0063 inch blade when removing 250µm coating.
 For best results use .0080 inch blade when removing 900µm buffer.
 # For best results when stripping secondary buffer down to primary 250µm coating use blade size .021.
 ## For best results when stripping secondary buffer down to primary 500µm coating use blade size .028.
 † Includes tool individually boxed with cleaning tool, push tool and instructions.
 * Catalog numbers are for two cutter blade sets packaged together with a matching fiber guide lock. Each blade set consists of a pair of joined, matched blades which must be snapped apart prior to use. Matched cutter blade sets are NOT interchangeable, and must only be used with their matching half.

FIBER GUIDE SELECTION	
Fiber Coating or Buffer Dia. (µm) to Strip	Replacement Fiber Guide Cat. No. ▲
up to 180	MS1-RT-07
180-250	MS1-RT-10
250-343	MS1-RT-13
343-407	MS1-RT-16
407-457	MS1-RT-18
457-533	MS1-RT-21
533-635	MS1-RT-25
635-787	MS1-RT-31
787-889	MS1-RT-35
889-1016	MS1-RT-40
1016-1168	MS1-RT-46
1168-1321	MS1-RT-52
1321-1397	MS1-RT-55
1397-1600	MS1-RT-63
1600-1702	MS1-RT-67
1702-1778	MS1-RT-70
1778-1930	MS1-RT-76
1930-2057	MS1-RT-81
2057-2184	MS1-RT-86
2184-2362	MS1-RT-93

▲ Catalog numbers are for a single, individually packaged fiber guide with integral size indicator disk.

COMPLETE TOOLS AND REPLACEMENT BLADE SETS FOR JACKET STRIPPING					
Jacket Diameter (µm)	Blade dia. (in.)	Complete Tool Cat. No. ††	Replacement Cutter Blade Set Cat. No.*	Blade Color Code	
2.5	.098	.054	MS2-54S-D1	MS2-RB-54S	NATURAL
3.0	.118	.054	MS2-54S-D2	MS2-RB-54S	NATURAL
3.5	.137	.054	MS2-54S-D3	MS2-RB-54S	NATURAL

MS-1 and MS-2 components are not interchangeable.
 * Catalog are for two cutter blade sets packaged together with a matching fiber guide lock. Each blade set consists of a pair of joined, matched blades which must be snapped apart prior to use. Matched cutter blade sets are NOT interchangeable, and must only be used with their matching half.

REPLACEMENT HANDLE ASSEMBLY	
Handle Assembly*	Application
MS-1-FS	Fiber coating/buffer stripping up to 2360µm
MS-2-L	Jacket stripping up to 3.5mm

† Includes tool individually boxed with cleaning brush, push tool and instructions.
 †† Catalog numbers are for single individually packaged Jacket Guide (with integral size indicator disk).
 * Includes handle individually boxed with cleaning brush, push tool and instructions. Cutter blade set and fiber guide are NOT included.

OPTICAL FIBER TERMINOLOGY

Optical Fiber, made of glass, fused silica, or plastic transmits light much as metallic wire carries electricity. Optical fibers are encased in various ways to meet application requirements. Shown here are the typical components of optical fiber:

- BUFFER** - Material that protects an optical fiber from physical damage.
- COATING** - Material in intimate contact with the cladding surface, applied to preserve its integrity.
- CLADDING** - The dielectric material surrounding an optical fiber's core.
- CORE** - The central region of an optical fiber through which light is transmitted.
- MULTIPLE-FIBER RIBBON** - A formed, flat carrier of several optical fibers.
- OPTICAL CABLE** - A fiber, multiple fibers, or fiber bundle in a structure fabricated to meet optical, mechanical, and environmental specifications.

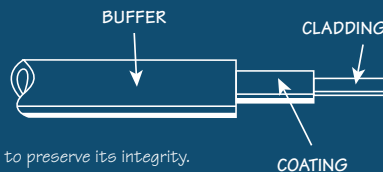

Contact the professionals at Fiber Optic Center for a quote or to get more details.

focenter.com • 508-992-6464 | (800) 473-4237 • sales@focenter.com

23 Centre Street • New Bedford, MA 02740 USA



Manufacturer:
Micro Electronics

Product Name:
Micro-Strip Strripper, .0210 (533um) Blade, .0630 (1600um) Guide

Manufacturer Part Number:
MS1-21S-63-FS

▶ [Click here for more details on the Micro-Strip Strripper, .0210 \(533um\) Blade, .0630 \(1600um\) Guide](#)

Micro-Strip® /Soft-Strip® Cutter Blade Replacement

TO REMOVE INSTALLED BLADES:

1. Using flat end of push tool, remove fiber guide lock by pushing out from the back side of tool head.
2. Remove Fiber guide from tool.
3. Using prong end of push tool in small holes on back side of tool head, eject blade set.

IMPORTANT!

Do not remove cutter blades while fiber guide is still in tool.

TO INSTALL NEW BLADES:

(Furnished in a matched set for blade precision. Snap apart before installation.)

1. Install with "ears" pointing toward top of tool and recess marks visible. Push firmly with flat end of push tool until both blades are seated.
2. Insert fiber guide through hole in top of tool until it stops.
3. Insert fiber guide lock through slot in front of tool head.

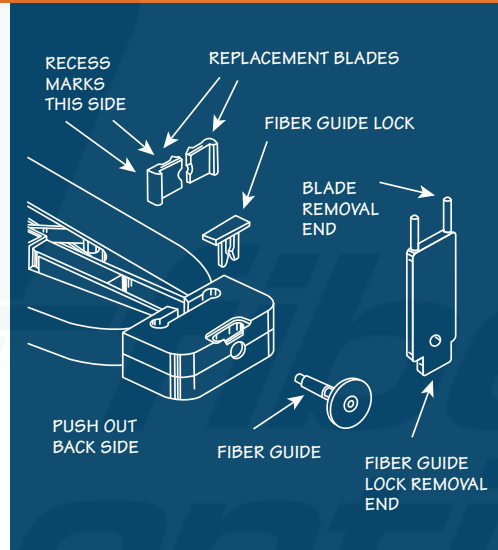

Note: Blades are color coded and matched to diameter and color of fiber guide lock. Replace or install fiber guide and fiber guide lock as needed. Always test strip fiber after installing new blade set. Remove blades periodically and clean with brush provided and alcohol.

The Best Non-Thermal / Thermal Stripping Tools

Accuracy

Every stripping component of the Micro-Strip® system is manufactured to tolerances tighter than 0.0005".

Error Proof

Because Micro-Strip®'s components are color coded, there's no chance for error, and virtually no chance of fiber damage. Every detail of Micro-Strip®'s design has been tested, retested, and proven in the field since 1973.

The Right Tool

You can order a variety of standard Micro-Strip® tools already fitted with your desired fiber guide and cutter blade set. You can also order replacement blade sets and guides so the same handle can be used to strip many sizes of fiber or cable.



Tool Kits

Convenient Micro-Strip® and Soft-Strip® kits include the most used components for fiber optic stripping, along with complete instructions, cleaning brush and component tool.

Versatility

There's no need to purchase separate tools for each fiber size. Micro-Strip®'s modular blade sets are quickly interchangeable and replaceable for coated optical fibers up to 2300µm, or jacketed fibers up to 3.5mm.

Low Stripping Force

Lower stripping force means less stress on the fiber and higher quality splices.

Micro-Strip® requires less than a pound of peak force for stripping coated fiber.

Contact the professionals at Fiber Optic Center for a quote or to get more details.

focenter.com • 508-992-6464 | (800) 473-4237 • sales@focenter.com

23 Centre Street • New Bedford, MA 02740 USA

Product specifications and data are subject to change without notice. FOC last update 04/27/2026.

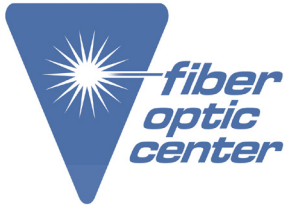

Manufacturer:
Micro Electronics

Product Name:
Micro-Strip Strripper, .0210 (533um) Blade, .0630 (1600um) Guide

Manufacturer Part Number:
MS1-215-63-FS

▶ [Click here for more details on the Micro-Strip Strripper, .0210 \(533um\) Blade, .0630 \(1600um\) Guide](#)

Micro-Strip® Kit Information

Fiber Optic and A.W.G. Wire Stripping Starter Kits



Fiber Optic Stripping Kit

This fiber optic stripping kit, **MS-FOK-1** contains stripping tool, blade and fiber guide components for both outer jacket stripping (up to 3.5mm) and coating/buffer stripping (up to 900µm). It comes packaged in an attractive metal case.



Fiber Optic Stripping Kit

This convenient three-step fiber optic stripping kit, **MS-FOK-2** contains Kevlar scissors and prefitted strippers for outer jackets (up to 3.5mm), 900µm buffers and 250µm coatings.



A.W.G. Wire Stripping Kit

This A.W.G. wire stripping kit, **MS-TK-1** is used for precision stripping of 18-32 gage fine wire. It contains a standard stripping handle with a variety of blade and guide components for stripping a wide range of solid or stranded wire.

Soft-Strip® Kit Information

Thermal Stripping Starter Kits



Multi-Fiber Thermal Stripping Kit

The **MS-SK-1** kit contains the patented Soft-Strip® thermal stripper and components necessary for stripping the most popular ribbon types including 2-12 fiber encapsulated, bonded or ribbonized constructions. It is powered by an AC wall outlet adapter (order separately).



Single-Fiber Thermal Stripping Kit

The **MS-SK-2** kit includes patented Soft-Strip® thermal stripper and components necessary for stripping discrete fibers with Cladding diameter up to 140µm and Coating/Buffer diameter up to 900µm. It is powered by an AC wall outlet adapter (order separately).

Contact the professionals at Fiber Optic Center for a quote or to get more details.

focenter.com • 508-992-6464 | (800) 473-4237 • sales@focenter.com

23 Centre Street • New Bedford, MA 02740 USA

Product specifications and data are subject to change without notice. FOC last update 04/27/2026.



Manufacturer:
Micro Electronics

Product Name:
Micro-Strip Stripper, .0210 (533um) Blade, .0630 (1600um) Guide

Manufacturer Part Number:
MS1-21S-63-FS

▶ Click here for more details on the Micro-Strip Stripper, .0210 (533um) Blade, .0630 (1600um) Guide

Additional Items, Accessories and Options



MICRO-STRIP® SCISSORS

MS-SZR-1 Reliable, multipurpose scissors for use in fiber optic and electrical service applications. Serrated models for non-slip Kevlar cutting and fiber or wire cutting. Stripping notches for 19 and 23 A.W.G. fine wire. File on back edge of blade to sharpen.



MICRO-STRIP® SCISSORS

MS-SZR-2 Ergonomic handle, reliable, multipurpose scissors for use in fiber optic and electrical service applications. Serrated models for non-slip Kevlar cutting and fiber or wire cutting. Stripping notches for 19 and 23 A.W.G. fine wire. File on back edge of blade to sharpen.

BLADE CLEANING BRUSHES



MS-CB-2 (double ended)

Both of these useful brushes are for removing residue from blade area normal to the stripping operation.

COMPONENT REMOVAL AND INSERTION TOOL



MS-PT-1 Facilitates easy removal for replacing or interchanging a wide range of Micro-Strip® blade set and fiber guide packages.

FIBER OPTIC SCRIBES



MS-FO-90-DW For a wide cutting surface, the deluxe 90° Wedge Diamond Scribe is housed in an attractive retractable type metal casing.



MS-FO-60-SW For an even wider cutting surface, this 60° Wedge Sapphire Scribe is housed in an attractive retractable type metal casing.



MS-FO-60-DC This economy Diamond Scribe has a 60° conical point housed in an attractive retractable type metal casing.



MS-FO-90-DW MS-FO-60-SW MS-FO-60-DC

REPLACEMENT SOFT-STRIP® HEATER CARTRIDGES



MS-RHM-1 (for models **MS-3B** and **MS-4B**) Used with AA battery powered thermal stripper only. 30mm maximum strip length.

MS-RHM-2 (for models **MS-3T** and **MS-4T**) Used with AC adapter / 6V battery powered thermal strippers only. 60mm maximum strip length.

SOFT-STRIP® ADAPTERS



MS-T3 (North American / Japan Shown)



6 VOLT BATTERY CASE



MS-BC-2 This convenient 6V battery case can be worn on your belt. It's ideal for field work when no electrical power is available.

It works with the same thermal stripper as the AC adapter. Leads are included.

Contact the professionals at Fiber Optic Center for a quote or to get more details.

focenter.com • 508-992-6464 | (800) 473-4237 • sales@focenter.com

23 Centre Street • New Bedford, MA 02740 USA

Product specifications and data are subject to change without notice. FOC last update 04/27/2026.

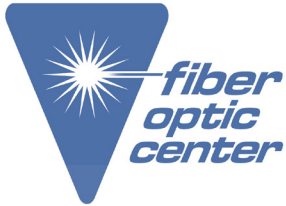

Manufacturer:
Micro Electronics

Product Name:
Micro-Strip Stripper, .0210 (533um) Blade, .0630 (1600um) Guide

Manufacturer Part Number:
MS1-21S-63-FS

▶ Click here for more details on the Micro-Strip Stripper, .0210 (533um) Blade, .0630 (1600um) Guide

Manufacturer Part Number:

MS-FOK-2	MS-4T-16S-21-FS	MS1-16S-67-FS	MS1-31S-55-FS	MS1-28S-40-FS	MS1-05S-10-FS	MS1-RB-04S
MS-FOK-1	MS1-23S-76-FS	MS1-16S-70-FS	MS-4T-12S-13-FS	MS1-31S-46-FS	MS1-05S-21-FS	MS1-RT-35
MS1-08S-40-FS	MS1-25S-63-FS	MS-4T-12S-25-FS	MS1-28S-76-FS	MS1-31S-52-FS	MS1-05S-07-FS	MS1-RB-37S
MS1-06S-10-FS	MS1-54S-67-FS	MS1-23S-81-FS	MS1-37S-86-FS	MS1-31S-40-FS	MS-4T-05S-18-FS	MS1-RB-54S
MS1-10S-13-FS	MS-4T-08S-35-FS	MS1-25S-52-FS	MS1-37S-93-FS	MS1-34S-46-FS	MS-4T-06S-07-FS	MS-RHM-1
MS1-08S-52-FS	MS-4T-08S-31-FS	MS1-14S-63-FS	MS1-44S-46-FS	MS1-34S-52-FS	MS1-05S-46-FS	MS1-RT-40
MS1-08S-55-FS	MS-4T-06S-10-FS	MS1-14S-67-FS	MS-4T-10S-31-FS	MS1-18S-35-FS	MS1-21S-81-FS	MS1-4T-E
MS1-10S-25-FS	MS1-34S-93-FS	MS1-16S-18-FS	MS1-28S-86-FS	MS1-18S-25-FS	MS-4T-16S-25-FS	MS1-RT-67
MS1-10S-31-FS	MS1-37S-55-FS	MS1-16S-21-FS	MS1-28S-93-FS	MS1-34S-40-FS	MS-4T-16S-31-FS	MS-T3
MS1-10S-35-FS	MS1-54S-86-FS	MS1-14S-16-FS	MS1-31S-35-FS	MS1-21S-25-FS	MS-4T-16S-35-FS	MS-RHM-2
MS1-10S-46-FS	MS-4T-06S-16-FS	MS1-14S-35-FS	MS-4T-10S-16-FS	MS1-21S-40-FS	MS1-06S-07-FS	MS1-RT-46
MS1-10S-52-FS	MS1-16S-46-FS	MS1-14S-46-FS	MS-4T-25S-31-FS	MS1-25S-46-FS	MS-3T-06-G6	MS1-RT-52
MS1-10S-55-FS	MS1-16S-52-FS	MS1-14S-52-FS	MS-4T-28S-31-FS	MS1-25S-31-FS	MS-3T-06-G8	MS1-RT-55
MS-4T-12S-35-FS	MS1-31S-93-FS	MS1-25S-67-FS	MS-4T-28S-35-FS	MS1-44S-93-FS	MS-3T-06-G10	MS1-RT-63
MS1-28S-63-FS	MS1-34S-63-FS	MS1-25S-70-FS	MS-4T-06S-10-FS	MS-SK-2	MS-3T-06-G5	MS1-RT-93
MS1-28S-67-FS	MS1-34S-81-FS	MS1-12S-55-FS	MS-4T-08S-13-FS	MS1-14S-40-FS	MS-4T-06S-13-FS	MS1-RT-65
MS1-12S-16-FS	MS-4T-08S-16-FS	MS1-12S-46-FS	MS-4T-10S-18-FS	MS1-16S-25-FS	MS-SK-1	MS1-RT-81
MS1-12S-25-FS	MS-4T-08S-18-FS	MS1-54S-93-FS	MS-4T-10S-21-FS	MS1-16S-31-FS	MS-3T-06-G2	MS-BL
MS1-12S-31-FS	MS-4T-08S-21-FS	MS-4T-12S-18-FS	MS-4T-05S-07-FS	MS1-18S-31-FS	MS1-RB-14S	MS2-RT-D2
MS1-18S-40-FS	MS1-23S-70-FS	MS1-23S-86-FS	MS-4T-05S-13-FS	MS1-23S-46-FS	MS2-54S-D1	MS1-RT-18
MS1-18S-46-FS	MS1-28S-81-FS	MS1-23S-63-FS	MS-4T-05S-16-FS	MS1-23S-25-FS	MS2-54S-D2	MS1-RT-07
MS1-18S-52-FS	MS1-31S-63-FS	MS1-23S-67-FS	MS-4T-25S-35-FS	MS1-23S-31-FS	MS1-21S-31-FS	MS1-RT-13
MS-4T-14S-16-FS	MS1-25S-76-FS	MS1-37S-46-FS	MS-4T-08S-10-FS	MS1-08S-13-FS	MS1-21S-46-FS	MS-2-L
MS-4T-14S-18-FS	MS1-21S-76-FS	MS1-54S-70-FS	MS-4T-14S-31-FS	MS1-08S-18-FS	MS1-RB-34S	MS1-RT-G2
MS-4T-14S-25-FS	MS1-21S-52-FS	MS1-54S-76-FS	MS-4T-21S-25-FS	MS1-08S-10-FS	MS1-RB-31S	MS1-RB-21S
MS-4T-21S-31-FS	MS1-28S-55-FS	MS1-54S-81-FS	MS-4T-14S-21-FS	MS1-10S-16-FS	MS1-RB-08S	MS3-RT-G10
MS-4T-21S-35-FS	MS1-18S-21-FS	MS1-34S-55-FS	MS1-06S-46-FS	MS1-12S-18-FS	MS-TK-1	MS1-RB-05S
MS-4T-18S-21-FS	MS1-18S-55-FS	MS1-18S-70-FS	MS1-05S-18-FS	MS1-12S-21-FS	MS-4B-E	MS1-RB-12S
MS-4T-18S-25-FS	MS1-16S-55-FS	MS1-21S-35-FS	MS1-05S-13-FS	MS1-12S-35-FS	MS1-RT-16	MS1-RT-10
MS-4T-18S-35-FS	MS1-12S-63-FS	MS1-18S-76-FS	MS1-05S-16-FS	MS1-14S-18-FS	MS1-RT-31	MS1-08S-35-FS
MS1-10S-21-FS	MS1-14S-55-FS	MS1-21S-55-FS	MS1-06S-25-FS	MS1-14S-21-FS	MS1-RB-16S	MS1-18S-67-FS
MS-4T-31S-35-FS	MS1-12S-52-FS	MS1-21S-63-FS	MS1-05S-25-FS	MS1-14S-25-FS	MS-4T-08S-40-FS	MS1-23S-70-FS
MS-4T-16S-18-FS	MS1-12S-40-FS	MS1-21S-67-FS	MS1-05S-31-FS	MS1-14S-31-FS	MS2-RT-D1	MS1-25S-35-FS
MS-4T-23S-25-FS	MS1-10S-40-FS	MS1-21S-70-FS	MS1-05S-35-FS	MS1-54S-63-FS	MS1-RB-10S	MS1-25S-55-FS
MS-4T-23S-35-FS	MS1-12S-13-FS	MS1-37S-40-FS	MS1-06S-21-FS	MS1-06S-13-FS	MS1-RB-06S	MS1-31S-67-FS
MS-4T-06S-25-FS	MS1-08S-46-FS	MS1-44S-67-FS	MS1-08S-25-FS	MS1-06S-40-FS	MS1-RB-18S	MS1-37S-70-FS
MS-4T-06S-31-FS	MS1-10S-18-FS	MS1-44S-70-FS	MS1-08S-31-FS	MS1-37S-52-FS	MS1-RB-44S	MS1-23S-52-FS
MS-4T-10S-13-FS	MS1-16S-35-FS	MS1-44S-76-FS	MS1-08S-21-FS	MS1-44S-52-FS	MS1-RB-23S	MS1-RT-25
MS-4T-10S-25-FS	MS1-06S-18-FS	MS1-34S-86-FS	MS-4T-06S-18-FS	MS1-44S-63-FS	MS1-RB-25S	MS1-RT-70
MS-4T-10S-35-FS	MS1-06S-31-FS	MS1-34S-67-FS	MS1-06S-35-FS	MS1-44S-86-FS	MS1-RB-28S	MS1-RT-76
MS-4T-18S-31-FS	MS1-06S-52-FS	MS1-34S-70-FS	MS1-18S-63-FS	MS-4T-05S-21-FS	MS-3T-E	MS1-RT-86
MS-4T-06S-35-FS	MS1-16S-40-FS	MS1-34S-76-FS	MS1-08S-16-FS	MS-4T-05S-25-FS	MS-1-FS	MS2-06/2-G20
MS-4T-08S-25-FS	MS1-06S-16-FS	MS1-37S-76-FS	MS1-23S-55-FS	MS-4T-05S-31-FS	MS1-RB-65S	MS2-06/2-G21
MS-4T-23S-31-FS	MS1-25S-93-FS	MS1-37S-63-FS	MS-4T-05S-35-FS	MS1-05S-52-FS	MS3-RT-G6	MS3-RB-06
MS-4T-12S-16-FS	MS1-25S-81-FS	MS1-25S-67-FS	MS1-23S-35-FS	MS-4T-21S-81-FS	MS3-RT-G8	MS3-RB-06/2
MS-4T-12S-21-FS	MS1-25S-86-FS	MS1-31S-70-FS	MS1-23S-40-FS	MS1-37S-81-FS	MS3-RT-G5	MS3-RT-G20
MS-4T-12S-31-FS	MS1-28S-35-FS	MS1-31S-76-FS	MS1-25S-40-FS	MS1-44S-55-FS	MS-CB-1	MS3-RT-G21
MS-4T-14S-35-FS	MS1-28S-52-FS	MS1-31S-81-FS	MS1-28S-46-FS	MS1-44S-81-FS	MS2-RT-D3	
MS-4T-06S-21-FS	MS1-16S-63-FS	MS1-31S-86-FS	MS1-28S-31-FS	MS1-05S-40-FS	MS2-RB-54S	

Contact the professionals at Fiber Optic Center for a quote or to get more details.

focenter.com • 508-992-6464 | (800) 473-4237 • sales@focenter.com

23 Centre Street • New Bedford, MA 02740 USA

Product specifications and data are subject to change without notice. FOC last update 04/27/2026.