

## Seiko Instruments SAP-8 Series Termination Procedures (Cord Type)

### 1.4 ASSEMBLY

#### 1.4.1 SELECTING A SUITABLE PLUG

Measure the outside diameter of the fiber using the ferrule selector and use a plug applicable to that diameter. Refer to the manual of the ferrule selector for detail.

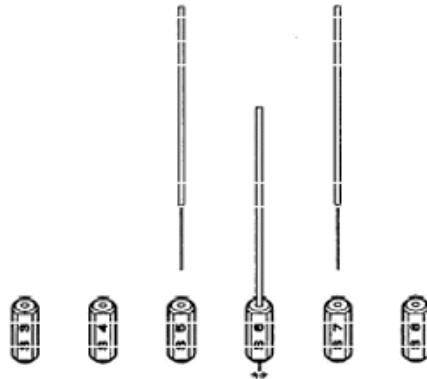

#### 1.4.2 SLIDING THE CONNECTOR PARTS ONTO THE FIBER CORD

Slide the connector parts onto the fiber as shown in the figure. Be sure the connector parts are installed in the right order and facing the correct direction.

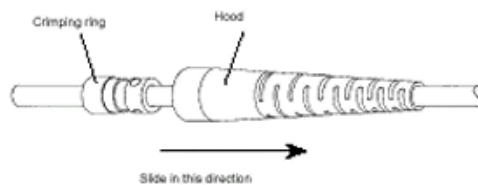

**Contact the professionals at Fiber Optic Center for more details.**

[focenter.com](http://focenter.com) • 508-992-6464 | (800) 473-4237 • [sales@focenter.com](mailto:sales@focenter.com)

23 Centre Street • New Bedford, MA 02740 USA

## 1.4.3 STRIPPING THE FIBER END

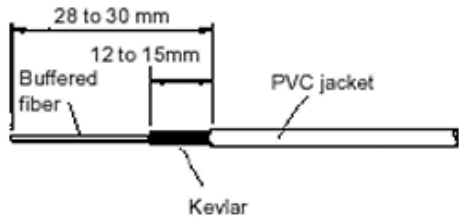

**Step 1** Using the wire stripper, Kevlar scissors and a scale, cut off the PVC jacket and the Kevlars to the length shown.



**Step 2** Fit the spiral tube to hold back the Kevlars in order to prevent them from scattering.



**Step 3** Using the fiber stripper and a scale, remove 12 to 15 mm of the nylon coating from the end of the cord as shown.

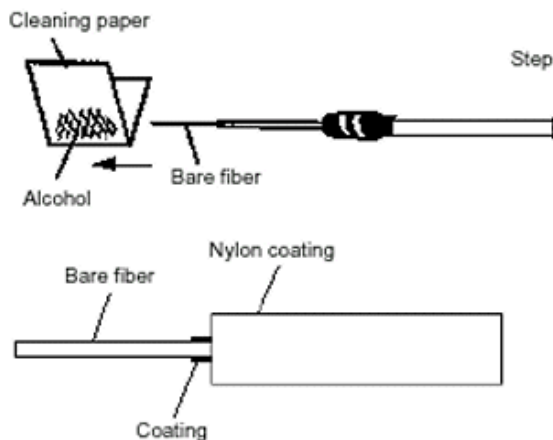

**Step 4** Wipe off the residual coating with a piece of cleaning paper moistened with ethyl alcohol.

**NOTE**

If residual coating remains on the fiber, adhesion between the ferrule and the fiber may be degraded, leading to deterioration of the connector performance. Coating at the root of the bare fiber may be left because it is difficult to remove.

**Contact the professionals at Fiber Optic Center for more details.**

[focenter.com](http://focenter.com) • 508-992-6464 | (800) 473-4237 • [sales@focenter.com](mailto:sales@focenter.com)

23 Centre Street • New Bedford, MA 02740 USA

## 1.4.4 PREPARING ADHESIVE



Step 1 Mix the main and curing agents of the adhesive Epo-Tek 353ND according to the instructions printed on the package of Epo-Tek.

Step 2 Pour the mixture into the mixing cup and leave it for several minutes until the foam dissipates.

Step 3 Pour the adhesive into the dispenser.

**NOTE**

Pour the adhesive gently so that there is no foam in the adhesive.

## 1.4.5 ADHERING FERRULE ONTO THE FIBER

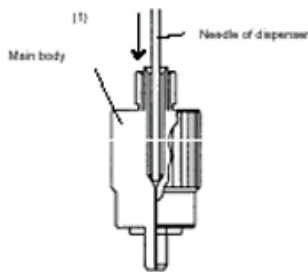

Step 1 Insert the needle of the dispenser into the main body of the plug from the tail until the dispenser stops.

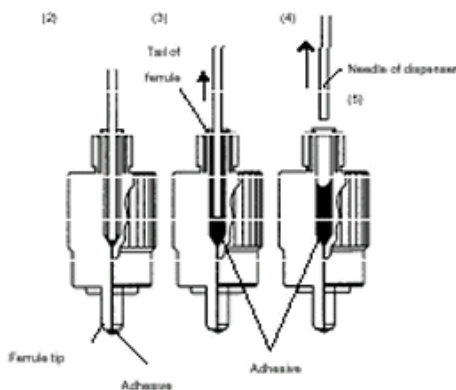

Step 2 Turn on the dispenser and inject adhesive until it comes out of the tip of the ferrule.

Step 3 When adhesive begins to come out from the tip of the ferrule, withdraw the needle about 1 to 2 mm. When adhesive begins to appear at the tail of the ferrule (the end part of the plug body), turn off the dispenser.

Step 4 Remove the dispenser from the plug.

**Contact the professionals at Fiber Optic Center for more details.**

[focenter.com](http://focenter.com) • 508-992-6464 | (800) 473-4237 • [sales@focenter.com](mailto:sales@focenter.com)

23 Centre Street • New Bedford, MA 02740 USA

# TERMINATION PROCEDURES

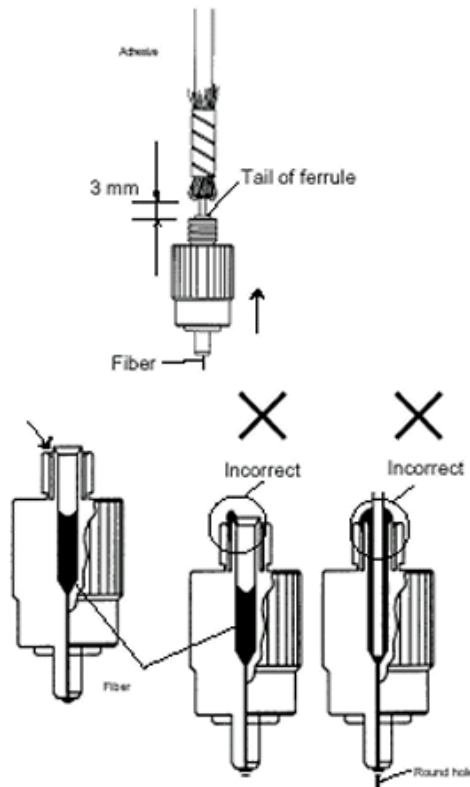

Step 5 Slide the plug onto the fiber slowly. Wipe off the excessive adhesive coming out of the tail of the ferrule.

**NOTE**

Take care so that adhesive will not pour into the part of the plug indicated by the arrow in the figure. Never attach adhesive to the Kevlars.

**1.4.6 HARDENING ADHESIVE**

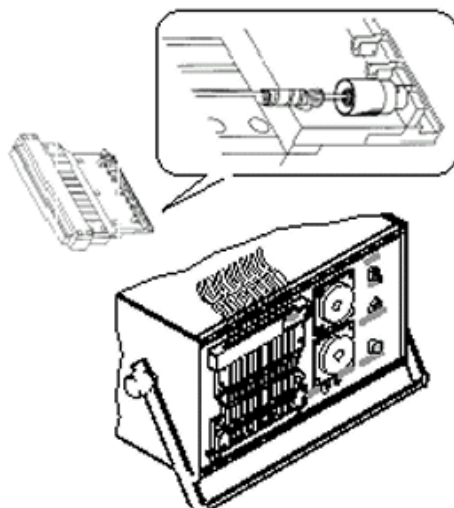

Step 1 Install the curing machine upside down as shown in the figure. Set the plugs on the cassette magazine and mount the cassette magazine on the OFK-1 curing machine. Adjust the temperature scale to 120 on the curing machine to harden the Epo-Tek 353ND. A maximum of 10 plugs can be cured at a time in the OFK-1 (For more details, see the curing machine manual).

**CAUTION**

During and immediately after the curing, do not touch the ferrule or the heater of the curing machine because they are very hot. Use tweezers to take the ferrule out after curing.

**Contact the professionals at Fiber Optic Center for more details.**

Step 2 After completion of the hardening, cut the fiber projecting from the face of the ferrule by making a notch by a slight touch of the fiber cutter and then lightly bending the fiber down to remove it.

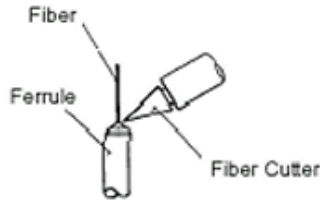

**CAUTION**

Do not snap the fiber by applying excessive force with the fiber cutter. Otherwise, the fiber will be snapped inside the ferrule. Take care not to let the cut end of fiber fly off because it is dangerous.

### 1.4.7 FINAL ASSEMBLY

Step 1 Remove the spiral tube with care. Trim the Kevlars at the position shown in the figure with the Kevlar scissors.

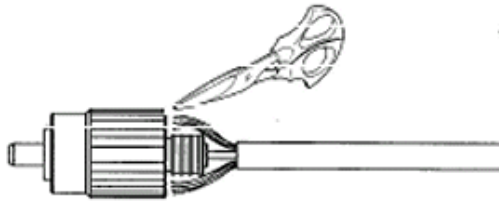

Step 2 Loosen the Kevlars and flare them with the tweezers.



Step 3 Slide the crimping ring over the plug with the Kevlars between them. Make sure the crimping ring is fully pressed against the plug.

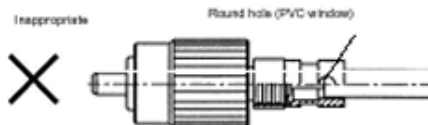
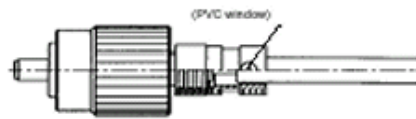

**NOTE**

Make sure that the Kevlars are not visible in the round hole on the rear part of the crimping ring.

Contact the professionals at Fiber Optic Center for more details.

[focenter.com](http://focenter.com) • 508-992-6464 | (800) 473-4237 • [sales@focenter.com](mailto:sales@focenter.com)

23 Centre Street • New Bedford, MA 02740 USA

# TERMINATION PROCEDURES

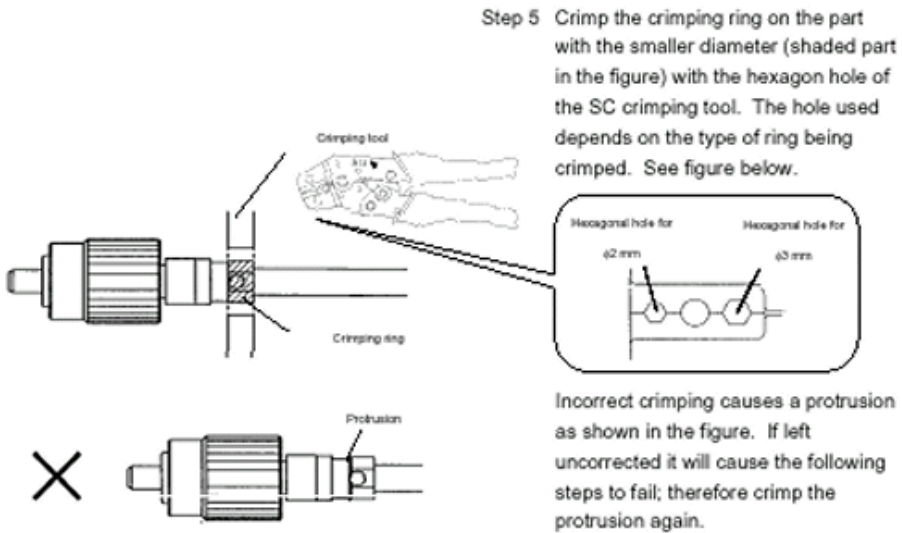
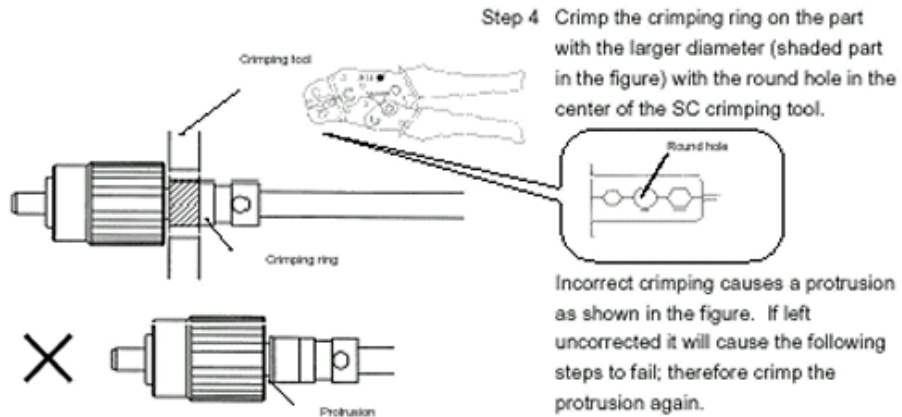

## 1.4.8 POLISHING FERRULE

Polish the ferrule referring to the *OFL-11/OFL-12 Instruction Manual* and *FC Plug Polishing Jig Instruction Manual*.

**Contact the professionals at Fiber Optic Center for more details.**

[focenter.com](http://focenter.com) • 508-992-6464 | (800) 473-4237 • [sales@focenter.com](mailto:sales@focenter.com)

23 Centre Street • New Bedford, MA 02740 USA

## Seiko Instruments SAP-8 Series Termination Procedures (Buffered Fiber Type)

### 2.4 ASSEMBLY

#### 2.4.1 SELECTING A SUITABLE PLUG

Measure the outside diameter of the fiber using the ferrule selector and use a plug applicable to that diameter. Refer to the manual of the ferrule selector for detail.

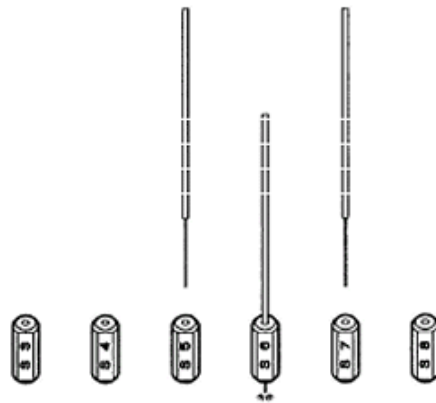

#### 2.4.2 SLIDING THE CONNECTOR PARTS ONTO THE FIBER

Slide the connector parts onto the fiber as shown in the figure. Be sure the connector parts are installed in the right order and facing the correct direction.

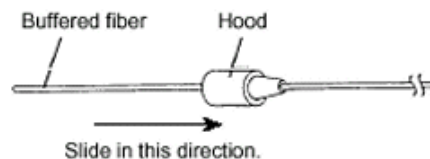

**Contact the professionals at Fiber Optic Center for more details.**

[focenter.com](http://focenter.com) • 508-992-6464 | (800) 473-4237 • [sales@focenter.com](mailto:sales@focenter.com)

23 Centre Street • New Bedford, MA 02740 USA

## 2.4.3 STRIPPING THE FIBER END

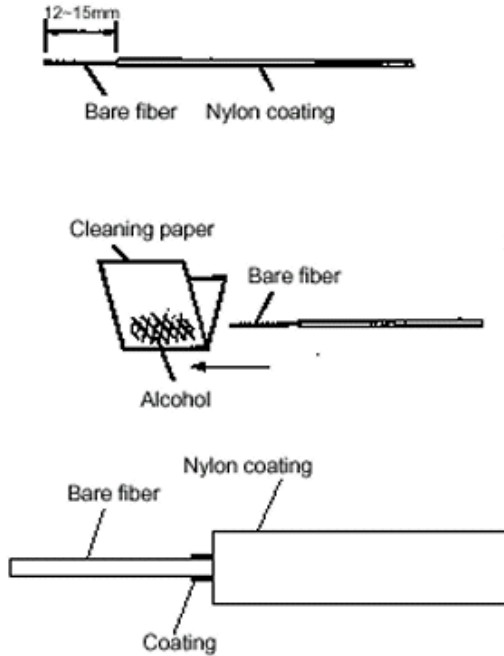

Step 1 Using the fiber stripper and a scale, remove 12 to 15 mm of the nylon coating from the end of the fiber as shown.

Step 2 Wipe off the residual coating with a piece of cleaning paper moistened with ethyl alcohol.

### NOTE

If residual coating remains on the fiber, adhesion between the ferrule and the fiber may be degraded, leading to deterioration of the connector performance. Coating at the root of the bare fiber may be left because it is difficult to remove.

## 2.4.4 PREPARING ADHESIVE



Step 1 Mix the main and curing agents of the adhesive Epo-Tek 353ND according to the instructions printed on the package of Epo-Tek.

Step 2 Pour the mixture into the mixing cup and leave it for several minutes until the foam dissipates.

Step 3 Pour the adhesive into the dispenser.

### NOTE

Pour the adhesive gently so that there is no foam in the adhesive.

Contact the professionals at Fiber Optic Center for more details.

[focenter.com](http://focenter.com) • 508-992-6464 | (800) 473-4237 • [sales@focenter.com](mailto:sales@focenter.com)

23 Centre Street • New Bedford, MA 02740 USA



## 2.4.5 ADHERING FERRULE ONTO THE FIBER

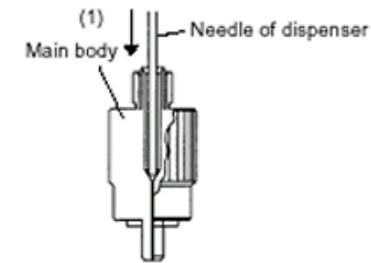

Step 1 Insert the needle of the dispenser into the main body of the plug from the tail until the dispenser stops.

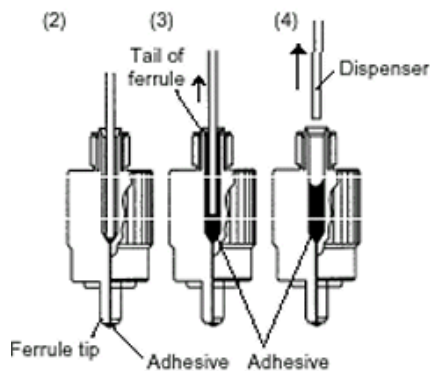

Step 2 Turn on the dispenser and inject adhesive until it comes out of the tip of the ferrule.

Step 3 When adhesive begins to come out from the tip of the ferrule, withdraw the needle about 1 to 2 mm. When adhesive begins to appear at the tail of the ferrule (the end part of the plug body), turn off the dispenser.

Step 4 Remove the dispenser from the plug.

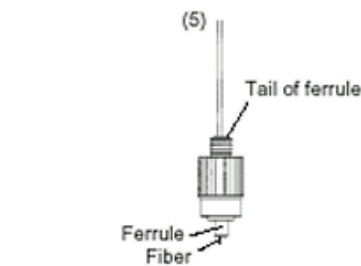

Step 5 Slide the plug onto the fiber slowly. Wipe off the excessive adhesive coming out of the tail of the ferrule.

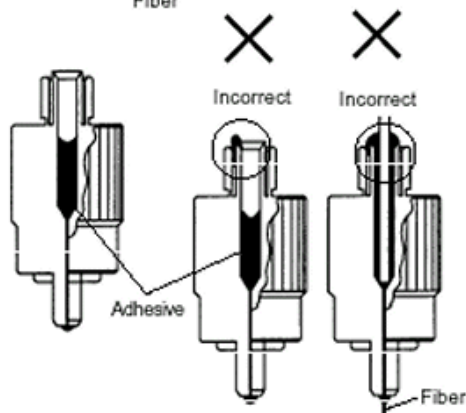

**NOTE**

Take care so that adhesive will not pour into the part of the plug indicated by the arrow in the figure. Never attach adhesive to the Kevlars.

Contact the professionals at Fiber Optic Center for more details.

[focenter.com](http://focenter.com) • 508-992-6464 | (800) 473-4237 • [sales@focenter.com](mailto:sales@focenter.com)

23 Centre Street • New Bedford, MA 02740 USA

## 2.4.6 HARDENING ADHESIVE

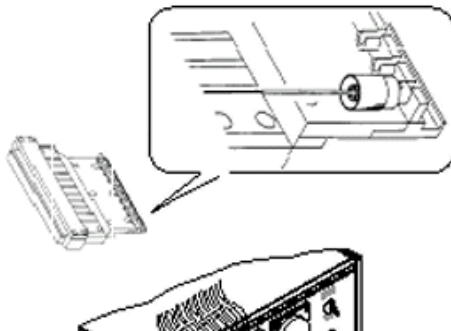

**Step 1** Install the curing machine upside down as shown in the figure. Set the plugs on the cassette magazine and mount the cassette magazine on the OFK-1 curing machine. Adjust the temperature scale to 120 on the curing machine to harden the Epo-Tek 353ND. A maximum of 10 plugs can be cured at a time in the OFK-1 (For more details, see the curing machine manual).

**CAUTION**

During and immediately after the curing, do not touch the ferrule or the heater of the curing machine because they are very hot. Use tweezers to take the ferrule out after curing.

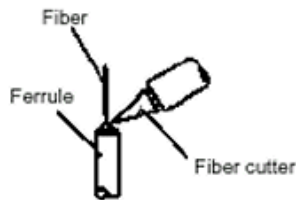

**Step 2** After completion of the hardening, cut the fiber projecting from the face of the ferrule by making a notch by a slight touch of the fiber cutter and then lightly bending the fiber down to remove it.

**CAUTION**

Do not snap the fiber by applying excessive force with the fiber cutter. Otherwise, the fiber will be snapped inside the ferrule. Take care not to let the cut end of fiber fly off because it is dangerous.

## 2.4.7 FINAL ASSEMBLY

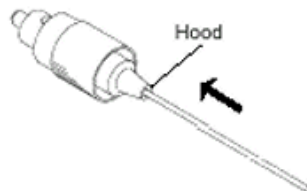

**Step 1** Slide the hood over the crimping ring.

## 2.4.8 POLISHING FERRULE

Polish the ferrule referring to the *OFL-11/OFL-12 Instruction Manual* and *FC Plug Polishing Jig Instruction Manual*.

**Contact the professionals at Fiber Optic Center for more details.**

[focenter.com](http://focenter.com) • 508-992-6464 | (800) 473-4237 • [sales@focenter.com](mailto:sales@focenter.com)

23 Centre Street • New Bedford, MA 02740 USA